



CATALOGO 2025

ANTEPRIMA

EFFICIENCY MEETS SILENCE

FRIGOBOX CRYOMASTER

EXPERIENCE OUTDOOR LUXURY

TAVOLI OUTDOOR GREYWOOD

HEAT-RESISTANT ELEGANCE

COLLEZIONE HOTMUG

DEALER WORKBOOK

Il settore dell'Outdoor e del camping sta vivendo una notevole trasformazione, con l'emergere di soluzioni innovative che rendono l'esperienza Outdoor più piacevole e confortevole che mai. Al centro di questa evoluzione ci sono le nostre ultime linee di prodotti, progettate per soddisfare le diverse esigenze degli appassionati di outdoor.

Le tende gonfiabili con il sistema Auto-Up garantiscono un montaggio e uno smontaggio senza sforzo, consentendo di immergersi nella bellezza della natura senza problemi. Inoltre, i nostri mobili da esterno di alta qualità possono essere riposti in modo compatto, assicurando che il vostro campeggio rimanga organizzato e privo di ingombri.

Riconoscendo l'importanza delle prelibatezze culinarie all'aria aperta, abbiamo introdotto pentole e padelle impilabili con caratteristiche specifiche per il campeggio, nonché le nostre eleganti stoviglie Stonetouch che combinano perfettamente qualità, funzionalità e un aspetto esteticamente piacevole.

Per combattere le temperature sempre più calde, i nostri moderni dispositivi di raffreddamento, come i frigoriferi a compressore e i condizionatori d'aria portatili, mantengono efficacemente un ambiente confortevole, permettendovi di godere appieno l'esperienza della vita itinerante.

Inoltre, il nostro programma "plastic-free" sta facendo passi da gigante, consentendoci di offrire prodotti e imballaggi sostenibili, a testimonianza del nostro impegno per la tutela dell'ambiente.

Siamo profondamente grati per l'instancabile impegno del nostro team di sviluppo e per la gioia che procura agli appassionati di outdoor. In vista della stagione outdoor 2025, attendiamo con ansia l'opportunità di condividere queste innovazioni con i nostri amici e partner, certi che miglioreranno l'esperienza del campeggio per gli anni a venire.



















Team Brunner

CATALOGUE PREVIEW

CONTENT



1		INTRO	2
2		TENTS	8
3		GAZEBOS & BEACH PARASOLS	72
4		CAMPING ACCESSORIES	82
5		FLOOR & DOOR	100
6		LAMPS & LANTERNS	114
7		SLEEP & RELAX	122
8		OUTDOOR FURNITURE	138
9		TABLE & KITCHEN	202
10		GAS ITEMS	290
11		HOUSEHOLD	310
12		COOLING	324
13		ELETRICAL PRODUCTS	338
14		WATER & SANITATION	366
15		TECHNIQUE	376
16		DISPLAY BOX	404



NUOVO O INNOVATIVO?

L'INNOVAZIONE ISPIRA E STIMOLA LA RICERCA DEL NUOVO.

Il nuovo, che aiuta l'uomo a rendere la propria vita più semplice, più confortevole e più sicura. L'innovazione è l'impulso che incita e ispira la ricerca, che la colma di capacità e saggezza.

L'acquisto di una nuova attrezzatura è un'importante decisione fatta sulla base di vari fattori come funzionalità, design, qualità, lavorazione ed il rapporto qualità/prezzo. Anche quest'anno il catalogo Brunner Outdoor 2025 propone una varietà di novità nei vari settori. Una varietà che aspetta di essere scoperta, provata e combinata per forme e colori. Sfogliate comodamente il catalogo oppure visitate il catalogo online, per trovare prodotto e prezzo più adatti alle vostre esigenze.

originaldesign ➔



INNOVATIONS

OUR PATENTS

I NOSTRI BREVETTI

I brevetti sono rappresentativi dell'inventiva e della voglia di innovazione di un'azienda e indubbiamente utilissimi per migliorare la prestazione dei prodotti.

Alcuni dei nostri articoli, come ad esempio le popote con sistema Vacublock, che definiscono un nuovo standard funzionale e offrono ai camperisti il massimo comfort in termini di utilizzo, sono stati brevettati in vari paesi con lo scopo di proteggere la nostra esperienza e conoscenza.

VACUBLOCK System

PATENTED



PLASTIC FREE

TOWARDS A CLEANER WORLD



Brunner Outdoor vuole essere in prima linea nell'impegno verso un mondo più pulito. È per questo che siamo orgogliosi di aver dato inizio ad un processo che nell'arco di 3-5 anni porterà ad un azzeramento del packaging commerciale realizzato in materiale plastico. Questo processo, oltre a portare benefici concreti, si pone l'obiettivo di ulteriormente sensibilizzare la cultura del rispetto per il nostro pianeta di tutti gli amanti Outdoor, peraltro già particolarmente sensibili a questa tematica.



BASIC



STONEtouch®
PORCELAIN-LIKE AND BREAK-RESISTANT

**3-TONE
DESIGN**

Il continuo sviluppo e l'ottimizzazione dei nostri prodotti rende

**L'ESPERIENZA OUTDOOR SICURA
E CONFORTEVOLE**

IMPROVEMENTS



UTILIZZO SICURO

La sicurezza del consumatore finale è un elemento fondamentale della politica prodotti Brunner.

ALCUNI ESEMPI:

- Il rispetto della normativa Reach
- Il rispetto della certificazione CE
- Tessuti ignifughi
- L'utilizzo di meccaniche antiinfortunistiche
- Collaudi TÜV/GS



Hot & Cold

OUR SYSTEMS

Il rivoluzionario Twinair 5000 - ora con un sistema di riscaldamento integrato! Il comfort è assicurato tutto l'anno grazie alla nostra tecnologia all'avanguardia. Provate la climatizzazione portatile più avanzata per il vostro camper.

AUTO-UP
SYSTEM

Scoprite il futuro del comfort outdoor con il rivoluzionario sistema di gonfiaggio integrato AUTO-UP. Progettato per tende, verande e gazebo dotati di strutture pneumatiche a.i.r.tech, questa tecnologia all'avanguardia rivoluziona il processo di montaggio. Alimentato da una batteria ricaricabile LiOn, AUTO-UP offre prestazioni efficaci senza bisogno di fonti di alimentazione esterne.





MIX& MATCH



CRUISER



TITANIUM AXIA



POLARYS FREEZE SZ

COORDINA PER FORMA E COLORE.

Arreda in modo accogliente il tuo ambiente Outdoor e donagli un tocco di lusso. La vastità di colori e forme dei prodotti presenti nel catalogo Brunner rendono possibile un allestimento del tutto individuale senza rinunciare però alla fantastica armonizzazione di prodotti di diverse categorie merceologiche. Createvi il vostro ambiente personale - come a casa vostra!



ENJOY THE EXPERIENCE

Tre parole speciali che hanno un significato differente per ogni persona che le legge. Ispirati dal bisogno delle persone a muoversi, abbiamo speso decenni a inventare, re-inventare e ottimizzare equipaggiamenti utili per tutti coloro che amano spendere il loro tempo libero in qualsiasi tipo di attività outdoor. Questo ci ha portati a realizzare una gamma di prodotti di alta qualità adatti per adeguarsi ai vostri bisogni e assicurare soddisfazione indipendentemente dai luoghi, dal clima e dalle condizioni meteorologiche. Combinando design e funzionalità realizziamo prodotti che rendono la vita outdoor un'esperienza emozionante senza fine.



COLOUR & DESIGN

C00	BIANCO	C25	ANTRACITE	C50	BIANCO/GRIGIO SCURO	C6T	DESIGN BLUEBAY	NEW COLOURS 2025	
C01	BEIGE	C28	DESIGN DENIM	C51	REBEL 3D BLUE	C6X	DESIGN PRALIN	C14	TIERRA FOREST
C02	MARRONE	C2E	DESIGN SANDHYA	C52	GRIGIO SCURO/GRIGIO CHIARO	C70	VERDE/GRIGIO	C15	DOLOMIT ROSÉ
C03	NERO	C2K	KASSANDRA	C53	SKYE/ARAVEL GRIGIO CHIARO	C71	TRASPARENTE	C16	TIERRA MAGMA
C05	NERO/BLU	C2M	NEON GIALLO	C55	NERO/AVIO	C73	GRIGIO/AVIO	C42	SALT & PEPPER
C06	GRIGIO	C2X	DESIGN PANAREA	C57	BLU/AZZURRO	C74	ARGENTO/BIANCO	C88	DOLOMIT YELLOW
C07	3D GRIGIO	C30	BLU	C58	PHANTOM GRIGIO	C7B	DESIGN SPACE	C2P	DOLOMIT ASSORTED
C08	AZZURRO	C31	KINETIC MARRONE	C59	BLU/GRIGIO	C7R	DESIGN DEEP SEA	C3A	ODETTE
C09	3D NERO	C33	KINETIC GRIGIO	C5B	DESIGN ESPRIT	C7T	SPHERICA	C4C	ODETTE BLACK
C10	ROSSO	C34	VERDE	C5L	DESIGN ENIGMA	C7X	DESIGN TIVOLI	C9B	COTTERY
C11	ARANCIO	C38	MARRONE RANCH/GRIGIO	C5R	DESIGN BBGRILL	C85	ARANCIO/GIALLO		
C19	GIALLO	C35	DESIGN GRANADA	C5S	ASTRALYS	C8A	DESIGN COSMIC		
C1C	DESIGN PEPITA	C43	VERDE CHIARO	C5T	DESIGN TUSCANY	C8C	DESIGN BLUE OCEAN		
C1M	DESIGN GRANYTE	C47	BLU ARCTIC	C5X	DESIGN PEARL	C8N	GRIGIO/ANTRACITE/NERO		
C1P	DESIGN GLAMOUR	C48	AVIO	C62	KINETIC GRIGIO	C8S	DESIGN NAUTICAL		
C1X	METEORE AZUR	C49	MARRONE SCURO/BEIGE	C63	KINETIC GRIGIO	C8X	DESIGN AMADÈ		
C20	NERO GRIGIO	C4E	DESIGN TULIP	C64	KINETIC BLU	C9D	VERDE SCURO		
C22	BLU SCURO	C4P	DESIGN SAVANA	C67	SKYE/ARAVEL GRIGIO SCURO	C9N	COLORI ASSORTITI		
C23	VIOLA	C4Q	BLU/ARGENTO	C69	REBEL 3D ANTHRACITE	C9X	VENETIAN		
C24	ROSSO CORALLO	C4X	DESIGN BELLAGIO	C6A	DESIGN SERENADE				

USED ICONS

Misure aperto	Misure chiuso	Misure	Peso
Portata	Tessuto	Sopratalo	Abitacolo
Catino	Misure abitacolo	Struttura	Differenziale termico
Paleria interna	Paleria esterna	Colonna d'acqua	Cuciture sigillate
l/min	Uso alimentare	Temperatura	Strati
Litri al minuto			
Imbottitura	Custodia	Tessuto interno	Tessuto esterno
Potenza	Volume	Funzionamento	Alluminio
Acciaio	Alluminio / Acciaio	Pressione	Tempo / durata
Attacco gas	LED	Lumen	Autonomia batteria

USED EXPLICATIVE LOGOS

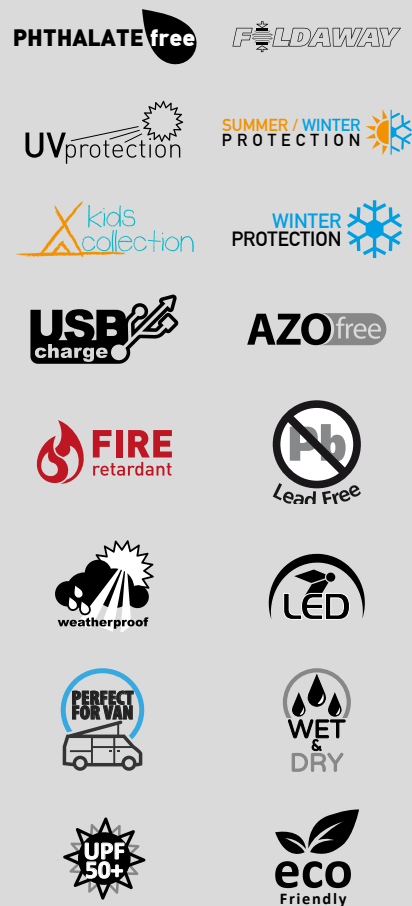

MARKETING SUPPORT

CON IL NOSTRO SUPPORTO MARKETING TRASPARENTE ED EFFICACE, VI FORNIAMO UN SOSTEGNO VERSATILE PER LE VOSTRE ATTIVITÀ DI VENDITA ONLINE E OFFLINE.

Utilizzate il know-how del nostro team di marketing e pubblicità per i vostri progetti. Parallelamente, la nostra ampia gamma di risorse di marketing, come immagini, video, reel e prodotti POS, è a vostra disposizione. Vi aiutiamo a fondere gli obiettivi commerciali e di marketing.



360°



VIDEO



REEL



POS PRODUCTS

WEB SUPPORT

BRUNNEROUTDOOR.COM



**SCOPRI IL NUOVO SITO BRUNNER
E IMPARA A CONOSCERE LE IDEE
CHE STANNO DIETRO AI NOSTRI PRODOTTI**

Un sacco di idee ed innovazioni che rivoluzionano l'avventura Outdoor ed un sacco di informazioni sulla gamma di prodotti Brunner.

Lasciati ispirare e metti insieme la tua attrezzatura in modo tale che soddisfi le tue esigenze e le tue aspettative. Resterai sorpreso dalla moltitudine di nuovi prodotti, dalle ottimizzazioni e dalle tante piccole migliorie, perché sono sempre i dettagli che fanno la differenza.



TENTS



LA TENDA MODERNA IN TUTTE LE SUE VARIANTI

La tenda rappresenta un'importante interfaccia dell'uomo con l'ambiente circostante, essa gioca un ruolo decisivo sullo stato del benessere degli occupanti durante il periodo del suo utilizzo. Già un modello Family medio garantisce un livello di comfort impensabile fino a pochi anni fa. Comfort che è diventato un elemento decisivo per l'apprezzamento ed il successo stesso del prodotto e che si caratterizza per:

- Materiali utilizzati
- Spazio interno, utilizzabile anche in caso di cattivo tempo
- Spazio per cucinare
- Velocità di montaggio
- Dotazioni comfort di serie (catino incernierato, entrate cavi elettrici, nastri fissacavi, tettucci parapiovvia, ecc.)
- Peso

PANORAMICA MODELLI TENDE

TENDE MINIBUS AUTO-UP	P. 10-11
TENDE MINIBUS A.I.R.TEC	P. 12-22
TETTUCCI PARASOLE A.I.R.TECH	P. 23-25
TENDE MINIBUS CLASSICHE	P. 26-29
TENDE POSTERIORI	P. 30-33
TETTUCCI PARASOLE	P. 34-37
TENDE FAMILY A.I.R.TECH	P. 40-49
TENDE FAMILY CLASSICHE	P. 50-51
TENDE TOURING	P. 52
TENDE AUTOMATIC	P. 53
CUCINOTTI E TENDE STORAGE	P. 54-61
GAZEBI OUTDOOR	P. 62-67
CONCHIGLIE PARASOLE	P. 68-69
PARAVENTO	P. 70-71





TROUPER AUTO-UP

TROUPER AUTO-UP

ART. 0102925N

€ TBC
1/1/-

- 150D Oxford Polyester PU (100% Polyester)
- AIRTUBE
- 310 x 260 x H230 cm
- 20,5 kg
- 80 x Ø 35 cm



Attenzione!
Non adatta per campeggio
stanziale/stagionale

Le verande per minibus Troupeur Auto-Up sono il naturale sviluppo della tecnologia A.I.R.Tech e consentono di completare le operazioni di montaggio, gonfiaggio e ancoraggio in pochi minuti e in assoluta comodità. Allo stesso tempo, viene eliminata la necessità di utilizzare i tradizionali pali in metallo o in fibra di vetro.

CARATTERISTICHE:

- Gonfiaggio automatico grazie alla pompa elettrica integrata con batteria ricaricabile
- Montaggio facile e veloce
- Collegamento con il tubo della tenda
- Include borsa e accessori di montaggio

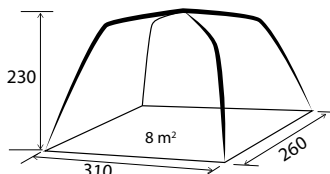

- Spalmatura (PU)
- Nastratura sopratelo
- Apertura aerazione
- Regolazione punti di ancoraggio
- Numero entrate (2)
- Finestre Panorama
- Catino cucito a chiusura totale
- Accessori di montaggio
- Sacca custodia

THE FUTURE IS HERE

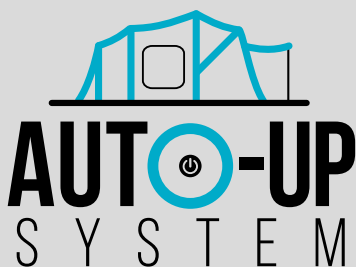

Il sistema di gonfiaggio integrato A.I.S. per tende, verande e gazebo dotati di strutture ad aria rappresenta una vera rivoluzione del settore. Immagina un montaggio rapido, senza sforzo ed estremamente confortevole. Dimentica le pompe ad aria manuali o i compressori elettrici da trasportare. Grazie alla batteria ricaricabile LiOn, sarai libero di goderti l'esperienza senza pensieri. Con A.I.S., potrai preparare il tuo rifugio in pochi minuti, consentendoti più tempo per rilassarti e goderti la tua avventura. Che tu sia un campeggiatore esperto o un principiante, A.I.S. renderà la tua vita Outdoor più semplice e pratica che mai. Scegli l'innovazione, scegli A.I.S.!

NEW
2025

SKIA AUTO-UP

100% Polyester
Weatherfighter

I tendalini parasole Skia Auto-Up sono il naturale sviluppo della tecnologia A.I.R.Tech e consentono di eseguire il montaggio, il gonfiaggio e l'ancoraggio in pochi minuti e in assoluta comodità. Allo stesso tempo, viene eliminata la necessità di utilizzare i tradizionali pali in metallo o in fibra di vetro. Utilizzando le pareti laterali (disponibili come optional), è inoltre possibile ottenere un ampio spazio abitativo protetto da vento, intemperie e sguardi indiscreti.

CARATTERISTICHE:

- Gonfiaggio automatico grazie alla pompa elettrica integrata con batteria ricaricabile
- Montaggio facile e veloce
- Collegamento con il tubo della tenda
- Include borsa e accessori di montaggio

OPZIONI DI COLLEGAMENTO AL VEICOLO:

- Con profilo keder 5/7 mm
- Con palo di collegamento

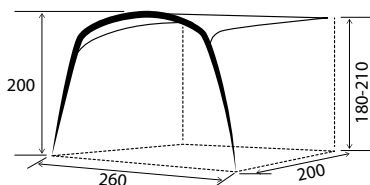

SKIA AUTO-UP

ART. 0102928N

€ TBC
1/1/-

100% Polyester 300D

260 x 200 x H200/210 cm

AIRTUBE

8 kg

70 x Ø 24 cm

 Double Connection 5/7
oneflate

Attenzione!
Non adatta per campeggio
stanziale/stagionale





DRIVE-AWAY AWNINGS



a.i.r.
tech
air inflation raising

INNOVAZIONE PER UN FUTURO PIÙ CONFORTEVOLE

Viaggiare in minibus significa libertà e flessibilità, ma richiede una certa autosufficienza e la possibilità di allestire rapidamente un accampamento mobile. Sia che preferiate fare un breve week-end con gli amici o coccolare la vostra famiglia con una settimana di vacanza rilassante, la nostra collezione di verande minibus con telaio ad aria è la soluzione ideale se desiderate un po' più comfort, spazio e un montaggio semplice e senza problemi. Godetevi una vacanza da sogno senza stress ed arrabbiature. La collezione di verande minibus Brunner continuerà a crescere e sarà ampliata da numerosi e interessanti nuovi modelli. Gli sforzi per un funzionamento ottimale, l'alta qualità e l'ulteriore sviluppo del livello di comfort rimangono invariati:

- La creazione di spazio aggiuntivo per vivere, dormire e ripostiglio
- Utilizzo alternativo come zona cottura per mantenere i fastidiosi odori fuori dall'abitacolo del veicolo
- La possibilità di prenotare la tua piazzola preferita anche in caso di assenza

Le tende ad aria Brunner A.I.R.Tech sono disponibili per diverse altezze di montaggio.



QUICK MOUNTING



Valvole per gonfiaggio rapido



Sistema di gonfiaggio Oneflate



Portellone con porta separata a destra

AIR TRAVEL II

INFO P. 14

INFO



Tutti i modelli di tende e verande Brunner con la denominazione Polycotton sono realizzate con uno speciale tessuto dalle eccellenti proprietà outdoor.

Si tratta di un materiale non spalmato che si sigilla naturalmente con un contenuto di cotone del 40%, ma senza rinunciare alle proprietà positive del tessuto in poliestere (contenuto 60%).

CIÒ COMPORTA I SEGUENTI VANTAGGI:

- Traspirante, quindi sensibile miglioramento del clima interno della tenda/veranda
- Significativa riduzione della formazione di acqua di condensazione
- Significativamente più resistente ai raggi UV rispetto alle tende in poliestere comparabili
- Maggiore longevità operativa



AIR TRAVEL II

La Air Travel II, di nuova concezione, è dotata di una struttura ad aria A.I.R. Tech di alta qualità con sistema di gonfiaggio Oneflate. Tutti gli elementi in tessuto sono realizzati in robusto policotone Pure Pro, che conferisce alla tenda un clima interno molto piacevole e una scarsa formazione di condensa. L'elevata resistenza ai raggi UV garantisce una durata estremamente lunga della tenda.

CARATTERISTICHE:

- Struttura pneumatica A.I.R. Tech altamente stabile e indipendente
- Sistema di gonfiaggio ad una sola camera (struttura ad aria monocamera)
- Ampio ingresso anteriore, che può essere allestito come tettoia parasole (2 pali inclusi), completamente rimovibile, finestre colorate con oscuramento
- Ingresso laterale a destra, configurabile come tettuccio parasole
- Portellone con porta separata a destra
- Parete posteriore completamente rimovibile, apribile a metà, utilizzabile come veranda (frangivento)
- Grandi finestre laterali oscurate con zanzariera e oscuranti
- Piccole finestre oscurate nel soggiorno, con oscuranti
- Stuoia veranda
- Balza perimetrale esterna
- Tensionamento della tenda mediante robuste cinghie
- La tenda può essere montata con elastici a scaletta in PVC sostituibili
- Accesso ai cavi con serratura nella parete posteriore
- Ganci ed elementi in velcro per il fissaggio delle lampade
- Include una pompa d'aria di alta qualità con valvola di sicurezza
- Borsa extra large con cinghie di compressione
- Per veicoli con altezza grondaia di 180 - 210 cm

OPZIONI DI COLLEGAMENTO AL VEICOLO:

- Con profilo keder 5/7 mm
- Con palo di collegamento
- Cinghie di fissaggio con clip per le barre del tetto
- Corde per il fissaggio passando sul tetto



REEL



a.i.r.
tech
air inflation raising



Valvole per gonfiaggio rapido



Sistema di gonfiaggio Oneflate



Portellone con porta separata a destra

AIR TRAVEL II

ART. 0102956N

€ TBC
1/1/-

- Polycotton
- PE
- 370 x 320 x H210 cm
- AIRTUBE
- 28,5 kg
- 80 x Ø 30 cm

Double Connection 5/7

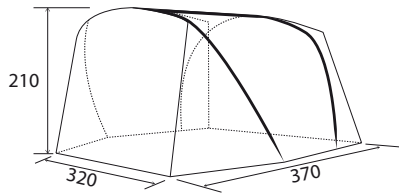

- Nastratura sopratalo
- Balza perimetrale
- Regolazione punti di ancoraggio
- Numero entrate (2)
- Finestre Airama
- Finestre Panorama
- Stuoia veranda
- Zanzariera ingressi
- Rinforzi punti max. sollecitazione
- Gancio appendilampada
- Corde tensione prefissate
- Accessori di montaggio
- Sacca custodia





a.i.r. tech
air inflation raising

<O>
oneflate

WISE

PFCfree

100% Polyester

Veranda indipendente con struttura gonfiabile A.I.R. Tech. I due archi portanti e la tettoia sono collegati tramite i tubi del tetto. Ciò consente un allestimento molto rapido mediante il sistema di gonfiaggio Oneflate. Tutte e quattro le pareti (compresa quella posteriore) sono rimovibili. Tre elementi della parete sono dotati di una finestra a zanzariera con copertura in Crystal colorata ed oscurante. La parete anteriore è dotata di entrata. Questa veranda può essere fissata a veicoli di diverse altezze con il nostro sistema a 2 tunnel di collegamento. Il catino cucito perimetralmente conferisce alla veranda una maggiore stabilità, protegge dal vento e dall'acqua piovana e tiene lontani gli insetti.

CARATTERISTICHE:

- Possibilità di scegliere tra tre misure di tunnel di collegamento: 190 cm - 220 cm e 220 cm - 250 cm
- Struttura pneumatica A.I.R. Tech altamente stabile e indipendente
- Sistema di gonfiaggio ad una sola camera (telaio ad aria monocamera)
- Tutte e 4 le pareti (compresa la parete posteriore) possono essere rimosse e utilizzate con effetto veranda; la parete posteriore può anche essere aperta a metà
- Tre pareti intercambiabili, ciascuna con finestra in zanzariera e una finestra in pellicola Crystal colorata con oscurante
- Parete anteriore con ingresso
- Tunnel di collegamento con porta separata a destra
- Catino completamente cucito
- Tensionamento della tenda mediante robuste cinghie
- Accesso per cavi con chiusura lampo nella parete posteriore
- Ganci ed elementi in velcro per il fissaggio delle lampade
- È inclusa una pompa d'aria di alta qualità con valvola di sicurezza
- Borsa di trasporto extra large con cinghie di compressione

OPZIONI DI COLLEGAMENTO AL VEICOLO:

- Con profilo keder 5/7 mm
- Con palo di collegamento
- Cinghie di fissaggio con clip per le barre del tetto
- Corde per il fissaggio passando sul tetto

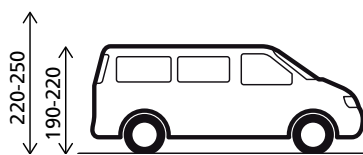
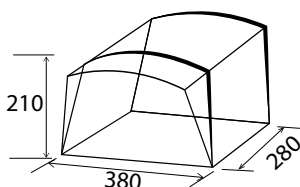

WISE

ART. 0102936N

€ TBC
1/1/-

Weatherfighter 300D Polyesterer

PE

380 x 280 x H210 cm

AIRTUBE

24 kg

80 x Ø 30 cm

<M> mountless Double Connection 5/7

LIVE YOUR DREAM



- Nastratura sopratelo
- Apertura aerazione
- Regolazione punti di ancoraggio
- Numero entrate (3)
- Finestre Panorama
- Catino completamente cucito
- Ingresso cavo sopratelo
- Rinforzi punti max. sollecitazione
- Gancio appendilampada
- Accessori di montaggio
- Sacca custodia





100%
Polyester
Oxford

TRAILS LC / HC



Tenda indipendente per Minibus con struttura pneumatica A.I.R. Tech a 2 archi. Accesso diretto al mezzo mediante entrata aggiuntiva nel tunnel di collegamento.

CARATTERISTICHE:

- Tutte le finestre sono oscurabili
- 2 entrate (1 anteriore - 1 laterale) con zanzariera
- Tettuccio frontale di protezione
- Ampio tunnel di collegamento
- 1 porta d'accesso attraverso il tunnel di collegamento
- Parete posteriore apribile completamente
- 2 aperture di ventilazione permanente
- Porta ingresso cavi elettrici con sistema portacavo
- Catino cucito a copertura totale
- Numerosi ancoraggi antibufera
- Ottima stabilità
- Con accessori di montaggio e sacca custodia
- Pali verticali inclusi

COLLEGAMENTO AL VEICOLO MEDIANTE:

- Profilo di scorrimento
- Asta di collegamento
- Nastri per corrimano con chiusura a contatto

Adatta per veicoli con altezza grondaia da 180 a 220 cm (TRAILS LC) / 245 a 280 cm (TRAILS HC)

Accessori di serie: palo di collegamento, corde tensione, picchetti, sacca custodia, pompa doppia azione.

Spalmatura (PU)

Nastratura sopratelo

Apertura aerazione

Regolazione punti di ancoraggio

Numero entrate (2)

Finestre Panorama

Catino cucito a chiusura totale

Accessori di montaggio

Sacca custodia



Attenzione!
Non adatta per campeggio
stanziale/stagionale

a.i.r.
tech
air inflation raising



TRAILS LC / HC

a.i.r
tech
air inflation raising

<M>
mountless

TRAILS LC

ART. 0102984N

€ TBC
1/1/12

Polyester Oxford PU 100% Polyester

PE

AIRTUBE

320 x (220+100) x H215 cm

18 kg

80 x Ø 33 cm

3000
 Double Connection
5/7

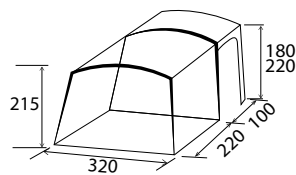

Tubi pneumatici a 3 strati

TRAILS HC

ART. 0102975N

€ TBC
1/1/9

Polyester Oxford PU 100% Polyester

PE

AIRTUBE

320 x (220+100) x H215 cm

18 kg

80 x Ø 33 cm

3000
 Double Connection
5/7

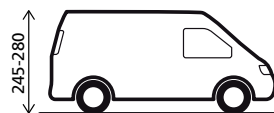
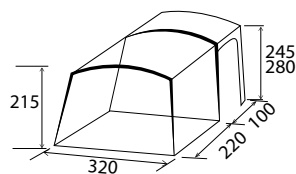

Pompa a doppia azione inclusa



a.i.r.
tech
air inflation raising



100%
Polyester
Oxford

TROUPER 2.0

TROUPER 2.0

ART. 0102995N

€ TBC
1 / 1 / 12

150D Oxford Polyester PU
(100% Polyester)

AIRTUBE

310 x 260 x H230 cm

20,5 kg

80 x Ø 35 cm



Spalmatura (PU)

Nastratura sopratelo

Apertura aerazione

Regolazione punti di ancoraggio

Numero entrate (2)

Finestre Panorama

Catino cucito a chiusura totale

Accessori di montaggio

Sacca custodia



Attenzione!
Non adatta per campeggio
stanziale/stagionale

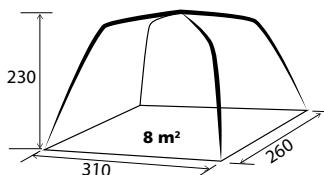

La nuova versione 2.0 della prestigiosa veranda per minibus Trouper, si presenta con una nuova struttura pneumatica, che ottimizza lo sfruttamento dello spazio a parità di superficie occupata. Tutte le altre caratteristiche esclusive della collezione di tende per minibus A.I.R. Tech rimangono invariate. Con un tunnel di collegamento che copre un'altezza da 180 a 230 cm, la Trouper 2.0 è adatta anche per l'uso su minibus di medie dimensioni.

CARATTERISTICHE:

- Spaziosa tenda per minivan
- Costruzione indipendente
- Costruita con tecnologia Crossbeam
- Porte d'ingresso con zanzariera
- Pompa a doppia azione inclusa
- Catino cucito perimetralmente
- Grandi finestre Panorama
- Ventilazione supplementare nel tetto
- Numerosi punti di controventatura

COLLEGAMENTO AL VEICOLO MEDIANTE:

- Profilo di scorrimento
- Asta di collegamento
- Nastri per corrimano con chiusura a contatto

Adatta per veicoli con altezza grondaia da 180 a 230 cm

Accessori di serie: telo tenda con catino, paleria, palo di collegamento, corde tensione, picchetti, sacca custodia

OPTIONAL

TROUPER CABIN

ART. 0102989N

€ TBC
6 / 12 / -

220 x 135 x H155 cm

100% Polyester

Camera interna per tenda Trouper 2.0/XL, fornibile come optional.







TROUPER XL





TROUPER XL

ART. 0102977N

€ TBC
1 / 1 / 9
 150D Oxford Polyester PU
(100% Polyester)

 AIRTUBE / Fiberglass

 (130+250) x 340 x H230 cm

 23,4 kg

 82 x Ø 38 cm

 3000mm

Spalmatura (PU)

Nastratura sopratelo

Apertura aerazione

Regolazione punti di ancoraggio

Numero entrate (2)

Finestre Panorama

Catino cucito a chiusura totale

Accessori di montaggio

Sacca custodia

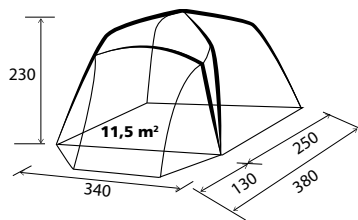

Tenda pneumatica per minibus sviluppata sulla base del modello A.I.R. Tech Trouper.

CARATTERISTICHE:

- Spaziosa tenda per minibus con grande abside anteriore
- Struttura pneumatica A.I.R. Tech con sistema di gonfiaggio Oneflate
- Costruzione indipendente
- Tecnologia Crossbeam
- Con pompa a mano con valvola di sovrappressione
- Catino cucito a copertura totale
- Porte d'ingresso con zanzariera
- Ampie finestre panoramiche
- Ventilazione aggiuntiva sul tetto
- Sopratelo con ingresso cavi
- Numerosi punti di controventatura
- Pali verticali inclusi
- Abitacolo opzionale

POSSIBILITÀ DI COLLEGAMENTO AL VEICOLO:

- Mediante profilo di scorrimento
- Mediante palo di collegamento
- Al corrimano mediante nastri con chiusura a contatto

Altezza di collegamento (grondaia del veicolo): 180-230 cm

Fornitura: telo esterno con catino, palo di collegamento, corde tensione, picchetti, sacca custodia



Attenzione!
Non adatta per campeggio
stanziale/stagionale



Sistema di gonfiaggio Oneflate



Ampie finestre panoramiche



ADVANTOURER

ADVANTOURER

ART. 0102970N

€ TBC
1 / 1 / 6

L'Advantourer è la tenda ideale per il vostro van. Grazie al suo telo esterno in policotone le sue prestazioni in termini di traspirabilità e resistenza ai raggi UV sono di gran lunga superiori rispetto alle tradizionali tende in poliestere.

CARATTERISTICHE:

- Struttura A.I.R. Tech, indipendente
- Catino cucito
- Tunnel di collegamento con porta d'accesso laterale
- Verandino frontale con laterali per la protezione dal sole e dalla pioggia
- Soggiorno con finestre con zanzariera (con oscuranti)
- Porta d'ingresso ampia e con zanzariera, con un'apertura variabile - parziale o completa
- Grande ingresso laterale
- Pali verticali inclusi

Adatta per veicoli con altezza grondaia da: 180 - 240 cm

- Polycotton
- Breathable Polycotton
- PE
- (140+200+100) x 350 x H230 cm
- AIRTUBE
- 32,1 kg
- 80 x Ø 41 cm



Attenzione!
Non adatta per campeggio
stanziale/stagionale

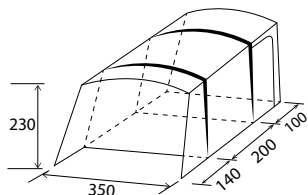

- Nastratura sopratelo
- Apertura aerazione
- Balza perimetrale
- Regolazione punti di ancoraggio
- Numero entrate (2)
- Finestre Panorama
- Catino cucito a chiusura totale
- Accessori di montaggio
- Sacca custodia



OPTIONAL

ADVANTOURER CABIN

ART. 0102971N

€ TBC
1 / 4 / 32

Camera interna (abitacolo) per tenda Advantourer, fornibile come optional.



SKIA 300/400



SKIA 300

ART. 0102931N

Polycotton

AIRTUBE

300 x 250 x H250 cm

70 x Ø 28 cm

13,5 kg

SKIA 400

ART. 0102932N

Polycotton

AIRTUBE

400 x 250 x H250 cm

70 x Ø 30 cm

15,5 kg

€ TBC
1/1/-

€ TBC
1/1/-

I tendalini parasole SKIA rappresentano il naturale sviluppo della tecnologia A.I.R.Tech e consentono di completarne l'inserimento, il gonfiaggio e l'ancoraggio in pochissimi minuti ed in assoluta comodità. Decade contemporaneamente la necessità di utilizzare i tradizionali pali in metallo o in fibra di vetro. Utilizzando le pareti laterali (disponibili come optional), è inoltre possibile ottenere un ampio spazio di soggiorno protetto dal vento, dalle intemperie e dagli sguardi indiscreti.

Lo SKIA è semplicissimo da montare grazie alla sua struttura pneumatica composta da un palo di sostegno anteriore ed ad un palo di stabilizzazione del tetto. Il collegamento al mezzo avviene mediante un profilo di scorrimento

precurato. Dal design moderno ed accattivante, questo tendalino parasole è prodotto utilizzando il speciale tessuto Pure Pro, un policotone con spalmatura PU che garantisce un'ottima resistenza ai raggi UV, un'ottima traspirabilità ed una lunga durata di utilizzo. Tutte le cuciture sono nastrate per garantire l'impermeabilità dell'ambiente interno.

La fornitura comprende una pompa per il gonfiaggio della struttura, gli accessori di montaggio (picchetti e corde tensione) ed una pratica borsa per il trasporto. Disponibile in 2 misure ed altezze di collegamento.

CARATTERISTICHE:

- Montaggio facile e veloce
- Con palo tetto pneumatico
- Connessione mediante profilo di scorrimento
- Include la pompa d'aria, la borsa ed il materiale di montaggio

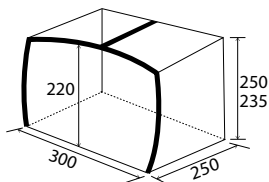

a.i.r. tech
air inflation raising

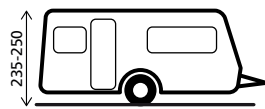
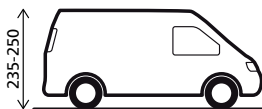
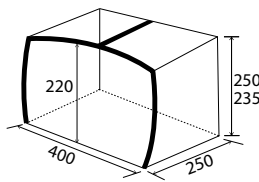

OPTIONAL

SKIA FRONTWALL 300

ART. 0102929N

€ TBC
1/1/1

SKIA FRONTWALL 400

ART. 0102930N

€ TBC
1/1/1

SKIA SIDEWALL SET

ART. 0102933N

€ TBC
1/10/-

Polycotton



Set 2 pareti laterali per tendalino parasole Skia (adatto per entrambe le misure del tendalino). Montaggio semplice e veloce.



RHOMBUS VAN

RHOMBUS VAN

ART. 0102957N

€ TBC
1/1/-

Polycotton

AIRTUBE

260 x 200 x H210 cm

66 x Ø 24 cm

11,2 kg

Double Connection
5/7

Bellissimo tendalino parasole per minibus e van. Pronto all'utilizzo in pochissimi minuti grazie alla sua solida struttura pneumatica. Realizzato interamente in tessuto Pure Pro ad alta resistenza UV. Utilizzando le pareti laterali (disponibili come optional), è possibile ottenere un ampio spazio di soggiorno protetto dal vento, dalle intemperie e dagli sguardi indiscreti.

CARATTERISTICHE:

- Struttura pneumatica A.I.R.Tech altamente stabile
 - Sistema di gonfiaggio mono-camera ad aria Oneflate
 - Numerosi punti di ancoraggio
 - Montaggio semplice e veloce
- Una pompa d'aria di alta qualità con valvola di sicurezza é inclusa.
Fornita con: picchetti, corde di ancoraggio e grande borsa per il trasporto

OPZIONI DI COLLEGAMENTO AL VEICOLO:

- Con doppio profilo di collegamento



Valvole per gonfiaggio rapido



Sistema di gonfiaggio Oneflate

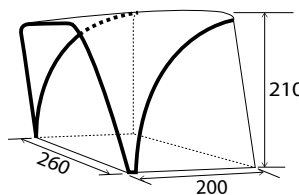

OPTIONAL



RHOMBUS VAN SIDEWALL SET

ART. 0102943N

€ TBC
1/10/-

Polycotton

Set 3 pareti per tendalino parasole Rhombus Van.
Montaggio semplice e veloce.



SKIA CAMPERVAN/CARAVAN

Tendalino parasole con telaio gonfiabile (tecnologia A.I.R. Tech) per caravan e furgoni. Pronto all'uso in pochi secondi. Montaggio semplice grazie alla pompa dell'aria fornita di serie. I tubi pneumatici flessibili prevengono possibili danni al veicolo anche in caso di forte vento. Con predisposizione per il fissaggio di pareti laterali opzionali. Sono inclusi gli accessori di montaggio.

VARIANTI DI COLLEGAMENTO AL VEICOLO

Con profilo keder 5/7 mm

Con set di adattatori magnetici (opzionale)

SKIA CAMPERVAN/CARAVAN

ART. 0103005N

€ TBC
1/1/25

 AIRTUBE

 280 x 240 x H190/210 cm

 150D Oxford Polyester PU (100% Polyester)

 65 x Ø 20 cm

 6,9 kg

 **<M>**
mountless  Double
Connection
5/7

a.i.r.
tech
air inflation raising

100%
Polyester
Oxford

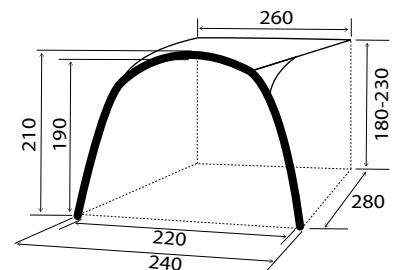

OPTIONAL

SKIA CAMPERVAN SIDEWALLS

ART. 0102964N

€ TBC
1/10/50

 150D Polyester

Set di due pareti laterali.



Attenzione!
Non adatta per campeggio
stanziale/stagionale



ENTRADA

Tenda per van indipendente di dimensioni compatte, adatta per il collegamento a veicoli con un'altezza grondaia di 180-220 cm.

CARATTERISTICHE:

- Montaggio semplice e veloce mediante classici pali in fibra di vetro
- Rapporto ottimale tra spazio e superficie grazie alla forma a tunnel
- Balza perimetrale
- Porte frontali e laterali alzabili a tettuccio parasole (con pali opzionali)
- Ottimo sistema di controventatura
- Ampia finestra trasparente
- Pratico ingresso laterale
- Aperture di ventilazione integrate

Collegamento al veicolo mediante:

- Profilo di scorrimento
- Asta di collegamento
- Nastri per corrimano con chiusura a contatto

La dotazione comprende: telo esterno, asta di collegamento, corde di tensione, picchetti, sacca custodia.

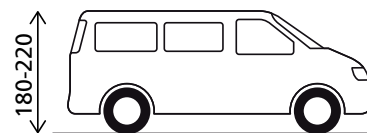
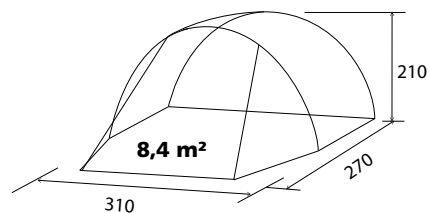

Attenzione!
Non adatta per campeggio
stanziale/stagionale

ENTRADA

ART. 0103006N

€ TBC
1 / 1 / 25

Polyester PU 100% Polyester

Fiberglass

External Poles

310 x 270 x H210 cm

10,5 kg

74 x Ø 24 cm

Spalmatura (PU)

Nastratura sopratele

Apertura aerazione

Balza perimetrale

Paleria precollegata

Regolazione punti di ancoraggio

Numero entrate (2)

Finestre Panorama

Accessori di montaggio

Sacca custodia

MIX & MATCH



POLARYS TRAVEL 28
P. 333



TITANIUM AXIA
P. 178



CRUISER
P. 157



ALBATROS

Tenda per Minibus moderna e indipendente.

CARATTERISTICHE:

- Parete anteriore removibile
- Entrata laterale con tettuccio
- Completa di balza perimetrale
- Con catino
- Ottima aerazione interna
- Tutte le finestre con copertura
- Parete posteriore chiudibile

POSSIBILITÀ DI FISSAGGIO AL MEZZO:

- Mediante profilo di scorrimento
- Mediante palo di collegamento
- Al corrimano mediante nastri con chiusura a contatto
- Mediante adattatore speciale per profilo (optional)

Altezza fissaggio (grondaia del veicolo): 180-220 cm

Accessori di serie: telo, catino, paleria, palo di fissaggio, tiranti, picchetti, sacca custodia.

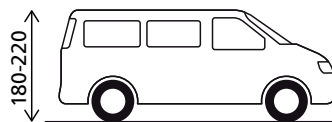
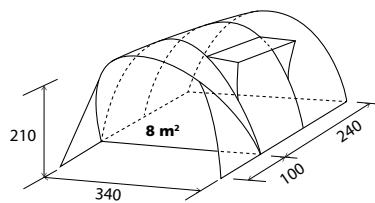

ALBATROS

ART. 0103052N

€ TBC

1 / 1 / 20

Pigment Polyester PU (100% Polyester)

Fiberglass

External Poles

340 x (100+240) x H210 cm

15,1 kg

70 x 25 x 25 cm

3000mm

LABEL READY



Attenzione!
Non adatta per campeggio
stanziale/stagionale

OPTIONAL



ALBATROS CABIN

ART. 0103053N

225 x 150 x H185 cm

Camera interna (abitacolo) per tenda Albatros.



MAGNETIC ADAPTER SET

ART. 7401016N

3 m

L'adattatore magnetico rappresenta un sistema semplice e pratico per collegarsi a veicoli sprovvisti di canalina. Aderisce perfettamente ai tetti piatti in lamiera di acciaio.

€ TBC
4 / 4 / 160

Spalmatura (PU)

Nastratura sopratelo

Apertura aerazione

Balza perimetrale

Paleria precollegata

Fissaggio paleria Ring-Pin

Regolazione punti di ancoraggio

Numero entrate (2)

Finestre Panorama

Catino cucito a chiusura totale

Accessori di montaggio

Sacca custodia



BEYOND

ART. 0103029N

€ TBC

1 / 1 / 20

68D Polyester PU 100% Polyester

Durawrap Fiberglass 12,7 mm

External Poles

240 x 340 x H210 cm

12 kg

75 x Ø 25 cm

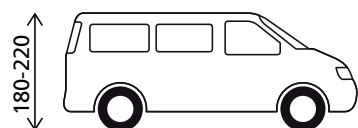
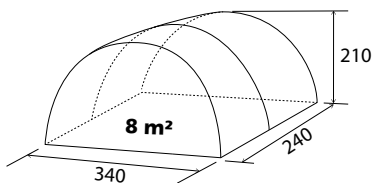

Spalmatura (PU)

Nastratura sopratelo

Apertura aerazione

Paleria precollegata

Fissaggio paleria Ring-Pin

Regolazione punti di ancoraggio

Numero entrate (2)

Finestre Panorama

Accessori di montaggio

Sacca custodia



Attenzione!
Non adatta per campeggio
stanziale/stagionale

BEYOND

Veranda indipendente con un eccellente rapporto qualità/prezzo.

POSSIBILITÀ DI COLLEGAMENTO AL VEICOLO:

- Mediante profilo di scorrimento
- Mediante palo di collegamento
- Al corrimano mediante nastri con chiusura a contatto
- Mediante adattatore speciale per profilo (optional)

Altezza di collegamento (grondaia del veicolo): 180-220 cm

Accessori di serie: telo esterno, paleria, asta aprichiusa, corde di tensione, picchetti, sacca custodia.



OPTIONAL

BEYOND CABIN

ART. 0103071N

€ TBC

1 / 12 / -

210 x 145 x H185 cm

Camera interna (abitacolo) per tenda Beyond.

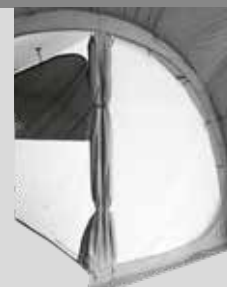



RAMBLER

ART. 0103019N

€ TBC
1 / 1 / 16

-  100% Polyester
-  Fiberglass
-  External Poles
-  350 x 260 x H220 cm
-  12,8 kg
-  74 x Ø 24 cm



RAMBLER

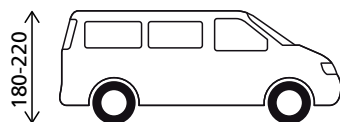
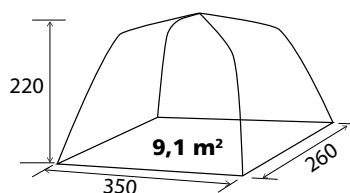

Spaziosa tenda per van e minibus di concezione moderna. Ottima ventilazione. Struttura collaudata e indipendente che permette di usufruirne del mezzo per eventuali escursioni senza smontare la tenda.

CARATTERISTICHE:

- 4 grandi finestre oscurabili
- 1 finestra con zanzariera di ventilazione
- 2 entrate
- Parete posteriore apribile completamente
- 2 aperture di ventilazione permanente
- Porta ingresso cavi elettrici con sistema portacavo
- Porta laterale alzabile a tendalino
- Catino cucito a copertura totale
- Numerosi ancoraggi antibufera
- Asola portalamпада centrale

COLLEGAMENTO AL VEICOLO MEDIANTE:

- Profilo di scorrimento
- Asta di collegamento
- Nastri per corrimano con chiusura a contatto

Adatta per veicoli con altezza grondaia: 180-220 cm
Accessori di serie: camera interna (abitacolo), telo tenda con catino, paleria, pali verticali, palo di collegamento, corde tensione, picchetti, sacca custodia.

Spalmatura (PU)

Nastratura sopratelo

Apertura aerazione

Paleria precollegata

Fissaggio paleria Ring-Pin

Regolazione punti di ancoraggio

Numero entrate (2)

Finestre Panorama

Catino cucito a chiusura totale

Accessori di montaggio

Sacca custodia



Attenzione!
Non adatta per campeggio
stanziale/stagionale



Finestre Panorama



Apertura antivento



Camera interna







100%
Polyester
Oxford

PILOTE CADDY 4

PILOTE CADDY 4

ART. 0102967N

€ TBC
1 / 1 / 48

-  150D Oxford Polyester
-  135 x 135 x H170/200 cm
-  2,5 kg
-  50 x Ø 12 cm

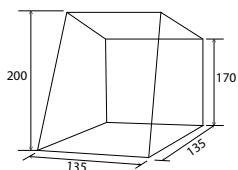

Tenda posteriore senza telaio appositamente sviluppata per essere fissata al portellone posteriore del VW Caddy. Ideale per creare ulteriore spazio nella parte posteriore del veicolo e per ottenere una maggiore libertà di movimento al suo interno. Montaggio semplice e veloce.

1 grande porta d'ingresso garantisce una buona ventilazione e un clima interno piacevole. Con materiale di fissaggio e borsa per il trasporto.



- Spalmatura (PU)
- Nastratura sopratelo
- Balza perimetrale
- Regolazione punti di ancoraggio
- Numero entrate (1)
- Finestre Panorama
- Accessori di montaggio
- Sacca custodia



Attenzione!
Non adatta per campeggio
stanziale/stagionale





PILOTE CADDY 5

100%
Polyester
Oxford

PILOTE CADDY 5

ART. 0102944N

€ TBC
1 / 1 / 48

 150D Oxford Polyester

 140 x 190 x H200 cm

 4,76 kg

 64 x Ø 16 cm

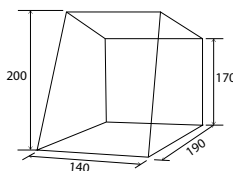

Spalmatura (PU)

Nastratura sopratelo

Balza perimetrale

Regolazione punti di ancoraggio

Numero entrate (1)

Finestre Panorama

Accessori di montaggio

Sacca custodia



Attenzione!
Non adatta per campeggio
stanziale/stagionale

Nuova tenda posteriore, senza telaio, ulteriormente sviluppata, applicabile al portellone posteriore del VW Caddy 5. Con questa tenda, molto ben accessoriata, l'abitacolo del Caddy si arricchisce di un comodo spazio per pranzare o per riporre i propri oggetti. La tenda viene fissata al portellone posteriore del veicolo con robuste cinghie. Le parti laterali sono fissate al veicolo con strisce magnetiche per renderle impermeabili alla pioggia. Nella zona inferiore, la Pilote Caddy 5 è legata saldamente al veicolo. La balza perimetrale esterna consente il deflusso di grandi quantità d'acqua. La parete anteriore può essere arrotolata o eretta come tettuccio parasole. Le due grandi finestre in zanzariera sul lato destro della tenda e sulla parete anteriore consentono un ottimo flusso d'aria. Le corde e i numerosi tiranti conferiscono alla tenda un elevato grado di stabilità.

CARATTERISTICHE:

- Tenda senza telaio con elevata stabilità al vento
- Robuste cinghie per il fissaggio al portellone posteriore
- Le pareti laterali possono essere fissate al veicolo, ben tese nella parte inferiore
- Parete anteriore completamente arrotolabile, con ampia finestra a rete (richiudibile con pellicola Crystal colorata, oscuramento interno)
- La parete anteriore può essere alzata a tettuccio parasole, con 2 pali inclusi
- Parete laterale destra con grande finestra in zanzariera, dotazione come nella parete anteriore
- Parete laterale sinistra con finestra fumé, oscuramento interno
- Balza perimetrale con occhielli
- Elastici a scaletta intercambiabili
- Picchetti in plastica da 30 cm
- Incl. borsa per il trasporto

MIX &
MATCH



POLARYS TRAVEL 28
P. 333



ELÛTOP COMPACT 80
P. 193



RAPTOR CLASSIC
P. 156



100%
Polyester
Oxford

Grazie alla facilità di montaggio, alla costruzione senza telaio e alle sue dimensioni compatte, la tenda COMET è la scelta ideale per tutti i possessori di furgoni VW T5-T6. Crea ulteriore spazio nella parte posteriore del veicolo, permettendo di stivare le biciclette, cucinare o dormire. Un modo perfetto per aggiungere un po' di spazio al vostro mezzo. Montaggio semplice e veloce posizionando la COMET sul portellone posteriore del T5 o T6. Non necessita di struttura portante. 2 ampie porte d'ingresso garantiscono una buona ventilazione ed un piacevole clima interno. Completa di accessori di montaggio, pali verticali e borsa di trasporto.

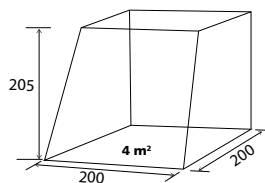

Attenzione!
Non adatta per campeggio
stanziale/stagionale

COMET

COMET

ART. 0102968N

€ TBC
1 / 1 / 48

 150D Oxford Polyester PU

 200 x 200 x H205 cm

 5,1 kg

 63 x 18 cm



Spalmatura (PU)

Nastratura sopratelo

Apertura aerazione

Balza perimetrale

Regolazione punti di ancoraggio

Numero entrate (2)

Finestre Panorama

Accessori di montaggio

Sacca custodia





ESCAPE

100%
Polyester
Oxford

ESCAPE

ART. 0102945N

€ TBC
1 / 1 / 48

 150D Oxford Polyester

 160 x 210 x H195 cm

 4,88 kg

 64 x 17 cm

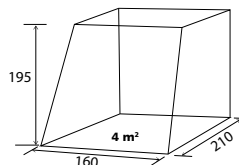

La tenda per portellone posteriore Escape, di nuova concezione, si adatta a diversi modelli di veicoli con struttura identica: Peugeot Traveller, Citroën Spacetourer e Toyota Proace. L'installazione è un gioco da ragazzi. Il tetto della tenda viene semplicemente posizionato sul portellone posteriore. Nella zona inferiore, il sopratelo della tenda è teso con numerosi elastici a scaletta sostituibili. Questa tecnica consente il montaggio senza attrezzi in pochi minuti. L'ampia parete anteriore può essere completamente arrotolata o essere alzata come tettoia parasole. Una grande finestra in zanzariera è cucita su questa parete e può essere chiusa con una pellicola Crystal colorata, con oscuramento all'interno. Entrambe le finestre laterali sono realizzate con pellicola Crystal oscurante. La balza perimetrale esterna protegge dall'acqua piovana. Le stabili corde di ancoraggio e i numerosi tiranti rendono la tenda molto stabile al vento.

CARATTERISTICHE:

- Tenda senza telaio con elevata stabilità al vento
- Lunga durata grazie al poliestere Oxford 150D
- Robuste cinghie per il fissaggio al portellone posteriore
- Le pareti laterali possono essere fissate al veicolo, ben tese nella parte inferiore
- Parete anteriore completamente arrotolabile, con ampia finestra in zanzariera (richiudibile con pellicola Crystal colorata, oscuramento interno)
- La parete anteriore può essere alzata a tettuccio parasole, con 2 pali di sostegno inclusi
- Pareti laterali destra e sinistra con finestra oscurata, oscuramento interno
- Balza perimetrale con occhielli
- Elastici a scaletta sostituibili
- Picchetti in plastica da 30 cm
- Ampia borsa di trasporto con cinghie di compressione

Spalmatura (PU)

Nastratura sopratelo

Apertura aerazione

Balza perimetrale

Regolazione punti di ancoraggio

Numero entrate (1)

Finestre Panorama

Accessori di montaggio

Sacca custodia



Attenzione!
Non adatta per campeggio
stanziale/stagionale



DEFLECTOR

SUNNY VIEW

DEFLECTOR QDR

ART. 0113065N

€ TBC
2 / 2 / 33

360 x 360 cm

100% PE

2,5 kg

Comodi tendalini parasole realizzati in materiale sintetico resistente ai raggi UV. Lati bordati e occhiellati. Facili da montare sui profili di scorrimento di caravan, camper, furgonati o minibus. Adatto alle verande Fiamma, Thule e Omnistor.



Double Connection 5/7 **PTHALATE free**

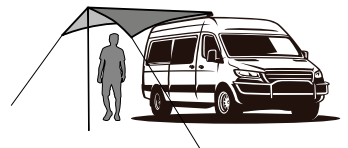

SET TELEPOLE

ART. 0305036N

€ TBC
1 / 1 / -

100 - 230 cm

PACK 2X

Pali verticali telescopici in alluminio anodizzato a tre elementi Ø 31/26/21 mm. Con puntale e base.

FIXING KIT SYSTEM INCLUDED



OPTIONAL



steel
Acciaio

VERTICAL POLES

ART. 0103004N

€ TBC
1 / 10 / 320

195 x Ø 1,6 cm

PCS. 2X

Pali verticali per tende.

FIXING KIT SYSTEM INCLUDED





Double Connection 5/7



BELVEDÈ



			€ TBC	M.O.	Master 
ART. 0106051N	280 cm	2,20 kg	€ TBC	2	2 -
ART. 0106052N	330 cm	2,40 kg	€ TBC	2	2 -
ART. 0106053N	380 cm	2,60 kg	€ TBC	2	2 -
ART. 0106054N	430 cm	2,80 kg	€ TBC	2	2 -
ART. 0106055N	480 cm	3,0 kg	€ TBC	2	2 -

Pratici pannelli frontali e laterali ombreggianti che completano la vostra veranda avvolgibile. Realizzati con il nostro speciale tessuto 2Mesh e una grande attenzione ai dettagli, questi complementi robusti e affidabili sono la soluzione perfetta per migliorare la vostra esperienza outdoor.

I pannelli frontali e laterali sono realizzati con materiali di alta qualità e assicurano una durata eccezionale nel tempo, per resistere alle intemperie stagione dopo stagione. Inoltre, tutti i pannelli Belvedè sono dotati di telo impermeabile che può essere arrotolato e fissato quando non viene utilizzato. Grazie al loro aspetto elegante e professionale, si integrano perfettamente nel vostro arredamento esterno conferendogli un aspetto armonioso ed elegante. Parete anteriore adatta alle tende da sole di tutti i principali produttori.



BELVEDÈ SIDEWALL

ART. 0106049N

€ TBC
1/1/-
 250 cm

Parete laterale per Belvedè.





SUNNY VAN ROOF

SUNNY VAN ROOF 260

ART. 0106030N

€ TBC

1 / 5 / 30

 260 x 240 cm

 Steel Ø 22/19 mm

 100% Polyester / Oxford PVC coating

 5,2 kg

 90 x 18,5 x 10 cm

SUNNY VAN ROOF 300

ART. 0106031N

€ TBC

1 / 5 / 25

 300 x 240 cm

 Steel Ø 22/19 mm

 100% Polyester / Oxford PVC coating

 6 kg

 90 x 20 x 12 cm

Tendalino parasole per Minibus. Il fissaggio al mezzo avviene tramite profilo di scorrimento o tramite palo di fissaggio in dotazione.

ACCESSORI DI SERIE:

- Picchetti
- Tiranti
- Pali verticali in acciaio
- Palo di fissaggio con morsetti



OPTIONAL

SUNNY VAN ROOF SIDEWALL SET

ART. 0106032N

€ TBC

1 / 1 / 48

 100% Polyester / Oxford PVC coating

 240 x H200 cm

 1,6 kg



Parete laterale per tendalino parasole SUNNY VAN ROOF con grande finestra panoramica. Montaggio semplice. Set 2 pz.







CARASHADE

CARASHADE

 300D Polyester PU

 Steel Ø 22/19 mm

 280 x 200 cm



Classico telo ombra per caravan con profilo di scorrimento. Completo di pali.

			M.O.	Master	
ART. 7130237N	280 x 200 cm	€ TBC	1	2	-
ART. 7130238N	340 x 200 cm	€ TBC	1	2	-
ART. 7130239N	400 x 200 cm	€ TBC	1	2	-
ART. 7130189N	200 x 240 cm	€ TBC	1	2	-
ART. 7130190N	250 x 240 cm	€ TBC	1	2	-
ART. 7130191N	300 x 240 cm	€ TBC	1	2	-
ART. 7130192N	350 x 240 cm	€ TBC	1	2	-
ART. 7130193N	400 x 240 cm	€ TBC	1	2	-
ART. 7130194N	450 x 240 cm	€ TBC	1	2	-
ART. 7130246N	260 x 250 cm	€ TBC	1	2	-
ART. 7130240N	380 x 260 cm	€ TBC	1	2	-
ART. 7130241N	420 x 260 cm	€ TBC	1	2	-





CAPTURE

ART. 0102988N

€ TBC

1 / 12 / -

Ø 5,4 cm

120 g

Ventosa per tenda per minibus con corpo in metallo. Set 2 pz.

ATACO

ART. 0102985N

€ TBC

6 / 6 / 288

Ø 11,5 cm

2x 238 g

Set di ventose con anello a D per il fissaggio senza viti di tendalini parasole, tende per minibus, teloni e molto altro ancora su superfici lisce. Possono essere caricate fino a max 12 kg. Set 2 pz.

FLAPLOCK

ART. 0301314N

€ TBC

10 / 20 / -

120 x 45 mm

95 g

Morsetto stabilizzante per tende e verande. Riduce fortemente l'eventualità di danni al tessuto in caso di forte vento. Corpo in materiale plastico. Set 2 pz.

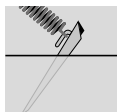

STABILIZER KIT UNIVERSAL

ART. 0301315N

€ TBC

10 / 10 / 200

1,2 kg

Kit cinghie stabilizzanti per verande caravan. Adatto per la maggior parte delle verande di produzione europea con fibbie premontate. Il set comprende 2 robusti picchetti di ancoraggio, 2 molle di scarico tensione e 2 cinghie di sicurezza.



STABILIZER KIT

ART. 0301311N

€ TBC

10 / 10 / 400

1,2 kg

Cinghia stabilizzante per verande camper e caravan in caso di vento. Il kit comprende: 1 nastro stabilizzatore (13 m) con molla di tensione e grandi picchetti di ancoraggio. Solo per uso temporaneo. L'utilizzo prolungato può provocare danni ai tessuti.

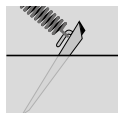

COMPLEMENTS





WHISPER ALU

ART. 0436002N

€ TBC
6 / 6 / 60

 1x 3000 CC

 10 x 22 x 54 cm

 1,2 kg

Pompa aria con pistone in alluminio e set adattatori.



ART. 7401020N

QEDER ADAPTER SET

With Textile Coating

M.O. Master

ART. 7401020N Ø 7 mm x 3 m € TBC 1 10 100

NEW 2025 ART. 7401018N Ø 5/7 mm x 4 m € TBC 1 10 150

ART. 7401018N



Kit per collegare la tenda minibus al veicolo.



MAGNETIC ADAPTER SET

ART. 7401016N

€ TBC
4 / 4 / 160

 3 m



L'adattatore magnetico rappresenta un sistema semplice e pratico per collegarsi a veicoli sprovvisti di canalina. Aderisce perfettamente ai tetti piatti in lamiera di acciaio.



LA CLASSICA TENDA FAMILY

a.i.r
tech
air inflation raising



Tubi pneumatici a 3 strati



Finestre Panorama



Entrata cavo



Porta con zanzariera

Una tenda si trasforma nella casa di famiglia durante le vacanze in campeggio. Quindi non c'è dubbio che debba essere adatta anche alla famiglia stessa. Mentre le coppie con un figlio non hanno bisogno di troppo spazio, le famiglie con tre figli o quelle che viaggiano con i nonni, hanno bisogno di spazio sufficiente per dormire comodamente, spazio per riporre attrezzature e bagagli, una saletta per giocare in caso di maltempo e spazio per un tavolo da pranzo con sedie. Le tende Family sono generalmente più grandi, progettate per tempi di permanenza più lunghi, per un maggior numero di persone ed offrono più comfort di una pura "tenda per il pernottamento".

Gli ingressi con altezza e le grandi finestre panoramiche sono una chiara caratterizzazione. L'interno delle tende Family è diviso in una zona notte e una zona giorno. Quest'ultima è di norma così spaziosa che è possibile sedersi insieme intorno al tavolo da campeggio mentre si prepara il cibo e i bambini si riposano nelle cabine letto. C'è molto spazio per tutti gli accessori che rivestono un ruolo importante per il successo di una piacevole vacanza.

Nelle pagine seguenti presentiamo una varietà di modelli che soddisfano le diverse esigenze; come il numero di persone, il peso, le dimensioni, l'altezza, le dimensioni dell'imballaggio, la ventilazione, ecc.

Ci dovrebbe essere qualcosa di adatto ad ogni esigenza.

Quindi: leggetele attentamente, ordinate dal vostro rivenditore e la divertente vacanza in campeggio può iniziare!

CREANOX



Tetto abitacolo con sistema Creanox



PURE

INFO P. 42



Valvole per gonfiaggio rapido



Aperture areazione



Tenditore per corda in alluminio a tre fori.



POLYCOTTON TENTS

INNOVAZIONE PER UN FUTURO PIÙ CONFORTEVOLE



La sfida principale degli ultimi anni si è concentrata sulla ricerca di materiali che ci permettessero la costruzione di telai pneumatici ad alta pressione rivoluzionari in grado di sostituire i tradizionali pali metallici o in fibra di vetro. L'idea dominante era quella di togliere la complessità dalle operazioni di montaggio delle tende e di offrire all'utilizzatore un elevato livello di semplicità e comfort.

I VANTAGGI DELLE TENDE IN POLICOTONE



Uno dei principali vantaggi delle tende in policotone è la maggiore traspirabilità e la capacità di adattarsi alle diverse condizioni dell'ambiente circostante.

Questo significa semplicemente che quando fa caldo, l'interno della tenda rimarrà più fresco rispetto alle tende in poliestere. Al contrario, con temperature più basse, la vostra tenda sarà più calda.

Traspirabilità significa anche che il policotone previene e riduce la formazione di condensa permettendo all'umidità di passare attraverso il tessuto, eliminando la sgradevole sensazione di umidità e garantendo benessere e comfort.

L'utilizzo del tessuto di policotone è altresì un investimento nella longevità della tenda. Il policotone offre una resistenza ai raggi UV molto più elevata rispetto al poliestere e il deterioramento dovuto agli effetti dell'invecchiamento è fortemente ridotto.

Nel complesso i tessuti in policotone garantiscono ottima funzionalità, traspirabilità e longevità, un mix interamente tecnologico per un prodotto che vi regalerà piacere nel tempo.



a.i.r.
tech
air inflation raising



PURE 4

60/40
Polycotton

- Apertura aerazione
- Balza perimetrale
- Abitacolo Creanox
- Divisorio abitacolo
- Fissaggio paleria Ring-Pin
- Regolazione punti di ancoraggio
- Pali verticali veranda
- Numero entrate (2)
- Finestre Airama
- Finestre Panorama
- Catino cucito a chiusura totale
- Zanzariera entrata abitacolo
- Zanzariera ingressi
- Ingresso cavo sopratelo
- Ingresso cavo abitacolo
- Rinforzi punti max. sollecitazione
- Tasche interne
- Gancio appendilampada
- Corde tensione prefissate
- Corde tensione riflettenti
- Accessori di montaggio
- Sacca custodia

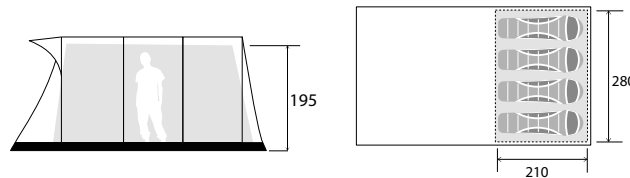
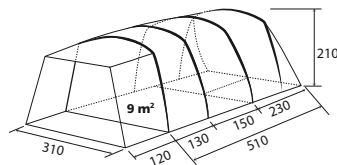

Pure 4 A.I.R. Tech Authentic è un'eccezionale modello di tenda per famiglie in cerca di molto spazio abitativo. Il tessuto traspirante in policotone mantiene l'interno notevolmente più fresco nelle calde giornate estive, soprattutto quando si trascorrono le vacanze nei climi più caldi. L'ampio verandino frontale garantisce un grande spazio per l'arredamento. Pali verticali inclusi.

PURE 4

ART. 0102972N

€ TBC
1/1/7

- Polycotton
- Breathable Polycotton
- 210 x 280 x H195 cm
- PE
- 630 x 310 x H210 cm
- AIR TUBE
- 37,6 kg
- 85 x Ø 44 cm

4x **<M>**
mountless



INFO CREANOX

Brunner Creanox è un nuovo sistema per tutti coloro il cui sonno è influenzato dalla luce del giorno.

Creanox filtra gran parte della luce diurna e consente un sonno più lungo e riposante - in qualsiasi momento della giornata.

Tutte le tende della collezione Brunner Family dotate del sistema Creanox sono contrassegnate in questo catalogo con un logo speciale.



MAISONEL 4

60/40
Polycotton

PFC free

La nuova tenda familiare Maisonel 4 è realizzata in tessuto misto cotone Pure Pro di alta qualità. Garantisce un clima interno molto piacevole in ogni stagione, è altamente resistente agli strappi e alla pioggia. Dotata dell'innovativo sistema di riposo Creanox, garantisce al campeggiatore una vacanza rilassante. La parte posteriore della tenda e la cabina interna sono molto scure e dotate di ampie aperture a rete. Il sistema di gonfiaggio A.I.R. Tech rende il montaggio molto semplice e veloce. L'ingresso laterale e una grande finestra a destra nella parete anteriore sono dotati di finestre a zanzariera richiudibili. Questo garantisce una buona ventilazione senza fastidiosi insetti. L'interno spazioso offre spazio confortevole per almeno 4 persone, che può essere ulteriormente ampliato rimuovendo la parete anteriore.

CARATTERISTICHE:

- Struttura pneumatica A.I.R. Tech altamente stabile e indipendente
- Catino cucito perimetralmente
- Parete anteriore completamente rimovibile, abbassabile a veranda, tutte le finestre in Crystal oscurato
- Entrata laterale con finestra in zanzariera, pellicola colorata ed oscurante
- L'entrata laterale può essere alzata come tettuccio parasole, 2 pali di montaggio inclusi
- Ampio abitacolo interno oscurato, parete divisoria apribile al centro con chiusura lampo, numerose tasche portaoggetti, sospensione per lampada, accesso cavi chiudibile dall'esterno
- Ampia zona giorno con tetto a veranda, all'interno con ganci e nastro in velcro per il fissaggio delle luci
- La tenda può essere messa in tensione con scalette in PVC sostituibili
- Tensionamento della tenda con cinghie robuste
- Accesso ai cavi con serratura sul lato destro
- È inclusa una pompa d'aria di alta qualità con valvola di sovrappressione
- Borsa extra large con cinghie di compressione











a.i.r.
tech
air inflation raising



MAISONEL 4

ART. 0102954N

€ TBC
1/1/-

-  Polycotton
-  Breathable Polycotton
-  280 x 240 x H220 cm
-  PE
-  570 x 300 x H240 cm
-  AIRTUBE
-  28,5 kg
-  85 x Ø 37 cm

4x **<M>**
mountless

CREANOX

INFO P. 43

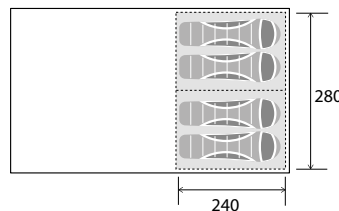
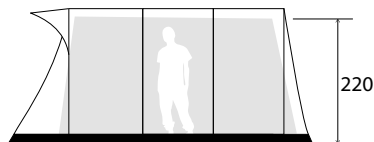
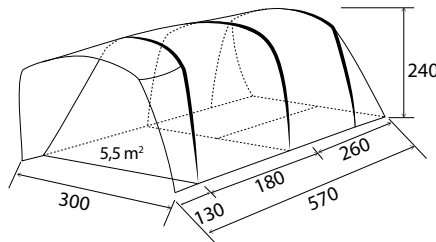

- Apertura aerazione
- Balza perimetrale
- Abitacolo Creanox
- Divisorio abitacolo
- Fissaggio paleria Ring-Pin
- Regolazione punti di ancoraggio
- Pali verticali veranda
- Numero entrate (2)
- Finestre Panorama
- Catino cucito a chiusura totale
- Zanzariera entrata abitacolo
- Zanzariera ingressi
- Ingresso cavo sopratelo
- Ingresso cavo abitacolo
- Rinforzi punti max. sollecitazione
- Tasche interne
- Gancio appendilampada
- Corde tensione prefissate
- Corde tensione riflettenti
- Accessori di montaggio
- Sacca custodia



POLYESTER TENTS

INNOVAZIONE
PER UN FUTURO
PIÙ CONFORTEVOLE



I VANTAGGI DELLE TENDE IN POLIESTERE



Premesso che esiste una quantità elevatissima di tessuti in poliestere e che per la realizzazione di materiali di alta qualità impiegati nell'Outdoor vengono utilizzate altre qualità che per semplici magliette o camicie, il poliestere si è rivelato un ottimo materiale per le seguenti ragioni: leggerezza, alta resistenza a strappi ed usura, buona resistenza UV, bassa dilatazione anche in condizioni di umidità.



a.i.r.
tech
air inflation raising











PARAISO

100%
Polyester
Oxford

PARAISO 5/6

ART. 0102981N

€ TBC
1 / 1 / 6

-  Polyester Oxford PU 100% Polyester
-  Breathable Polyester
-  (140+210) x 215 x H195 cm
-  PE
-  540 x 380 x H215 cm
-  AIRTUBE
-  24,8 kg
-  80 x Ø 35 cm

  5/6x

CARATTERISTICHE:

- Struttura pneumatica molto stabile
- 3 tubi aria indipendenti sistema A.I.R. Tech
- Catino a cucitura perimetrale
- Parete frontale rimovibile
- Grandi finestre Airama
- Tetto abitacolo con sistema Creanox
- Porta laterale dotata di zanzariera
- Ventilazione interna efficace
- Ampia veranda anteriore
- Con pompa a mano di alta qualità
- Sono inclusi picchetti in materiale plastico, corde tensione e borsa per il trasporto

La tenda Family pneumatica A.I.R. Tech Paraiso unisce in modo perfetto elementi di design moderno, tecnica di costruzione e funzionalità a 360 gradi. Grazie alle grandi aperture di aerazione ed alle ampie finestre panoramiche che sfiorano il catino, viene sempre garantito un'ottimo livello di ventilazione interna. Numerosi ed utili dettagli funzionali fanno sì che la Paraiso si monti con sorprendente velocità e facilità e che rappresenti, anche per questa ragione, il compagno perfetto per delle vacanze spensierate e divertenti.

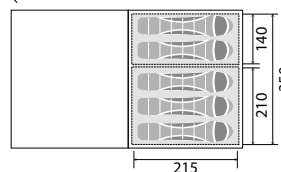
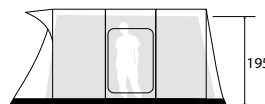
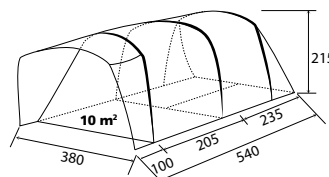

CREATONX INFO P. 43



Porta con zanzariera



Tetto abitacolo con sistema Creanox

- Spalmatura (PU)
- Nastratura sopratelo
- Apertura aerazione
- Abitacolo Creanox
- Divisorio abitacolo
- Regolazione punti di ancoraggio
- Pali verticali veranda
- Numero entrate (2)
- Finestre Panorama
- Catino cucito a chiusura totale
- Zanzariera entrata abitacolo
- Zanzariera ingressi
- Ingresso cavo sopratelo
- Ingresso cavo abitacolo
- Rinforzi punti max. sollecitazione
- Tasche interne
- Gancio appendilampada
- Corde tensione prefissate
- Corde tensione riflettenti
- Accessori di montaggio
- Sacca custodia



BULLET



BULLET 5

ART. 0102987N

€ TBC
1/1/6

150D Oxford Polyester PU (100% Polyester)

Breathable Polyester

(120+180) x 210 x H190 cm

PE

AIRTUBE

25,1 kg

85 x Ø 37 cm



Tenda Family con struttura pneumatica A.I.R. Tech a 3 archi e catino integrato in resistente tessuto PE.

CARATTERISTICHE:

- Ideale per famiglie
- Catino integrato
- 1 entrata anteriore
- 1 entrata laterale con tettuccio di protezione
- Grande tettuccio parasole fisso
- 2 abitacoli indipendenti
- Finestre Panorama
- Ottima ventilazione
- Ottimo rapporto spazio/superficie

CREANOX INFO P. 43



Tetto abitacolo con sistema Creanox

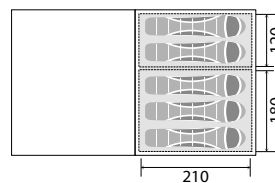
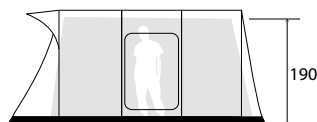
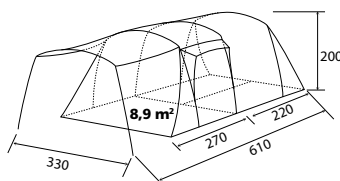

- Spalmatura (PU)
- Nastratura sopratelo
- Apertura aerazione
- Abitacolo Creanox
- Divisorio abitacolo
- Regolazione punti di ancoraggio
- Pali verticali veranda
- Numero entrate (2)
- Finestre Airama
- Finestre Panorama
- Catino cucito a chiusura totale
- Zanzariera entrata abitacolo
- Zanzariera ingressi
- Ingresso cavo sopratelo
- Ingresso cavo abitacolo
- Rinforzi punti max. sollecitazione
- Tasche interne
- Gancio appendilampada
- Corde tensione prefissate
- Corde tensione riflettenti
- Accessori di montaggio
- Sacca custodia

a.i.r.
tech
air inflation raising



INFO

DANNO ALLA STRUTTURA PNEUMATICA COSA FARE!

Tutti gli elementi della struttura (tubi pneumatici, valvole, ecc) sono realizzati con materiali di alta qualità ed una rottura è altamente improbabile durante il normale utilizzo. Nel raro caso di un danno esterno alla camera d'aria il problema è velocemente risolto dal momento che ogni singolo tubo pneumatico può essere rimosso e sostituito con facilità (fare riferimento alle istruzioni di montaggio).



1 entrata laterale con tettuccio di protezione



Finestre Panorama



Grande tettuccio parasole fisso



100%
Polyester
Oxford

KALINDA



KALINDA 5

ART. 0102999N

€ TBC
1 / 1 / 12

150D Oxford Polyester PU (100% Polyester)

Breathable Polyester

(200+140) x 220 x H195 cm

PE

Fiberglass / Steel

External Poles

20 kg

80 x Ø 27 cm

5x

CREATOPX INFO P. 43



Tetto abitacolo con sistema Creanox

Tenda Family con struttura classica a 3 archi e catino integrato in resistente tessuto PE.

CARATTERISTICHE:

- Ideale per famiglie
- Catino integrato
- 1 entrata
- 2 abitacoli indipendenti
- Finestre Panorama
- Ottima ventilazione
- Porta anteriore alzabile a veranda
- Ottimo rapporto spazio/superficie
- Pali verticali inclusi

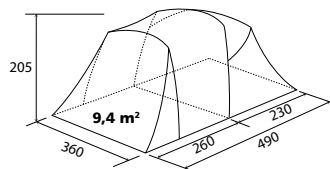
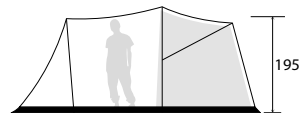
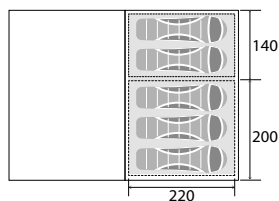

- Spalmatura (PU)
- Nastratura sopratelo
- Apertura aerazione
- Abitacolo Creanox
- Divisorio abitacolo
- Paleria precollegata
- Paleria con segnalini colorati
- Fissaggio paleria Ring-Pin
- Regolazione punti di ancoraggio
- Pali verticali veranda
- Numero entrate (1)
- Finestre Airama
- Finestre Panorama
- Catino cucito a chiusura totale
- Zanzariera entrata abitacolo
- Zanzariera ingressi
- Ingresso cavo sopratelo
- Ingresso cavo abitacolo
- Rinforzi punti max. sollecitazione
- Tasche interne
- Gancio appendilampada
- Corde tensione prefissate
- Corde tensione riflettenti
- Accessori di montaggio
- Sacca custodia



ARQUS



ARQUS OUTDOOR 5

ART. 0103057N

€ TBC
1 / 1 / 12

Polyester PU 100% Polyester

Breathable Polyester

300 x 220 x H195 cm

PE

Fiberglass

External Poles

16,5 kg

78 x Ø 26 cm

3000% UPF
 5x

Tenda a tunnel che con il suo ampio allestimento offre tanta sicurezza e comfort al campeggiatore Outdoor.

CARATTERISTICHE:

- Montaggio veloce
- Leggera
- 2 Ingressi
- Catino cucito a chiusura totale
- Finestre Crystal tinte
- Palaria codificata a colori
- Cuciture nastrate
- Gancio per lampade
- Parete divisoria della cabina interna chiudibile mediante cerniera
- Sono inclusi picchetti in plastica, tiranti, sacca custodia e pali verticali

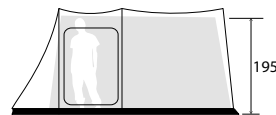
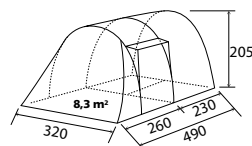
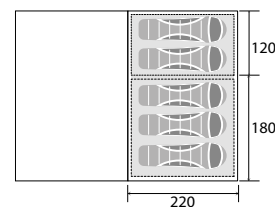

INFO

CONSIGLI PER L'UTILIZZO CORRETTO DELLA TENDA

Prima di partire per le vacanze in tenda effettuate sempre un montaggio di prova. In tal modo potrete arrivare a destinazione conoscendo già la procedura di montaggio e contemporaneamente verificare che tutto sia a posto. Applicate sempre le corde di controventatura badando a non esagerare con la tensione. In caso di forte vento sostituite i picchetti in dotazione con picchetti antibufera. Su terreni particolarmente duri o rocciosi è consigliato l'uso di appositi spilloni. Alcune condizioni meteorologiche favoriscono la formazione di condensa all'interno della tenda. Per minimizzare questo processo naturale evitate di appendere biancheria o abbigliamento bagnato nella tenda, aumentate il livello di ventilazione interna e utilizzate un telo di protezione salvacatino. Prima di riporre la tenda provvedete a togliere possibili residui di sporco mediante una morbida spugna bagnata con semplice acqua. Evitate di lavare la tenda con la lavatrice o mediante l'utilizzo di prodotti chimici. Controllate che la tenda sia completamente asciutta prima di ripiegarla per evitare formazione di muffa o cattivi odori. Infine è consigliabile portare sempre con sé un kit riparazione che includa pali ed elastici di ricambio, toppe adesive per la riparazione di eventuali strappi, cordini antibufera e qualche picchetto di riserva.

- Spalmatura (PU)
- Nastratura sopratelo
- Divisorio abitacolo
- Palaria precollegata
- Palaria con segnalini colorati
- Fissaggio palaria Ring-Pin
- Regolazione punti di ancoraggio
- Pali verticali veranda
- Numero entrate (2)
- Finestre Airama
- Catino cucito a chiusura totale
- Zanzariera entrata abitacolo
- Zanzariera ingressi
- Ingresso cavo sopratelo
- Ingresso cavo abitacolo
- Rinforzi punti max. sollecitazione
- Tasche interne
- Gancio appendilampada
- Corde tensione prefissate
- Corde tensione riflettenti
- Accessori di montaggio
- Sacca custodia



GLOBO



STRATO

GLOBO 3

ART. 0103083N

€ TBC
4 / 4 / 52

68D Polyester PU/Alu 100% Polyester

Breathable Polyester

210 x 205 x H125 cm

PE

Fiberglass

External Poles

5 kg

56 x Ø 21 cm

 2000 mm
 3x

La tenda a cupola è l'ideale compagno di viaggio grazie al peso leggero, al montaggio facile e veloce ed allo spazio sufficiente per il bagaglio. Sono inclusi picchetti in plastica, tiranti, sacca custodia.

Spalmatura (PU)

Nastratura sopratelo

Apertura aerazione

Paleria precollegata

Paleria con segnalini colorati

Fissaggio paleria Ring-Pin

Numero entrate (1)

Finestre Panorama

Catino cucito a chiusura totale

Zanzariera entrata abitacolo

Rinforzi punti max. sollecitazione

Tasche interne

Gancio appendilampada

Accessori di montaggio

Sacca custodia

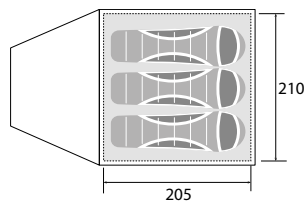
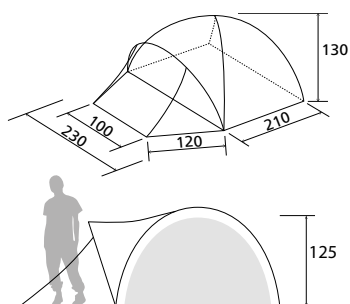

STRATO 2

ART. 0103088N.C70

€ TBC
6 / 6 / -

Polyester PU 100% Polyester

205 x 150 x H105 cm

PE

Fiberglass

External Poles

2,1 kg

64 x Ø 14 cm

 1000 mm
 2x

Tenda monotelo con apertura di ventilazione in sommità di cupola. Completa di accessori di montaggio e sacca custodia.

Spalmatura (PU)

Nastratura sopratelo

Apertura aerazione

Paleria precollegata

Pali verticali veranda

Fissaggio paleria Ring-Pin

Numero entrate (1)

Catino cucito a chiusura totale

Zanzariera entrata abitacolo

Tasche interne

Gancio appendilampada

Corde tensione riflettenti

Accessori di montaggio

Sacca custodia

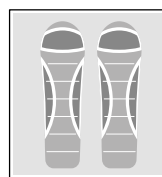
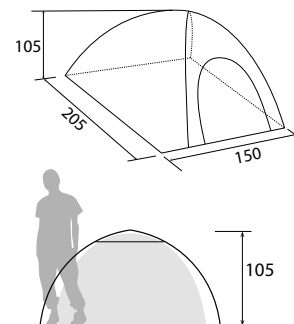







STRATO 2 AUTOMATIC

STRATO 2 AUTOMATIC

ART. 0102978N

€ TBC
2 / 6 / 84

-  100% Polyester
-  Fiberglass / Automatic
-  210 x 140 x H105 cm
-  2,3 kg
-  62 x Ø 15 cm



Tenda a cupola automatica per 2 persone. Montata e pronta all'uso in pochissimi secondi grazie allo speciale sistema di tensionamento a cavi integrati. Monotelo con grande porta chiudibile a cerniera. Completa di sacca custodia ed accessori di montaggio.

CARATTERISTICHE:

- Costruzione monotelo
- 2 aperture di ventilazione laterali
- Abitacolo con zanzariera
- Tasca interna
- Aste automatiche in fibra di vetro Ø 8,5 mm con trazione a fune
- Catino in materiale PE impermeabile

- Spalmatura (PU)
- Nastratura sopratelo
- Apertura aerazione
- Paleria precollegata
- Numero entrate (1)
- Catino cucito a chiusura totale
- Zanzariera entrata abitacolo
- Tasche interne
- Gancio appendilampada
- Accessori di montaggio
- Sacca custodia

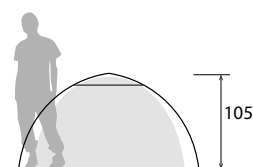
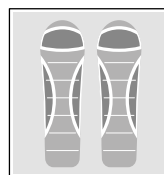
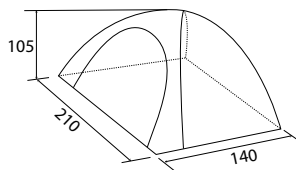

INFO

AUTOMATIC



CLICK

CLOSE





UN CUCINOTTO PER TUTTE LE OCCASIONI



CHEF II OUTDOOR

ART. 0426041N

€ TBC
1 / 1 / 20

 Polyester UV resistant 100% Polyester

 200 x 200 x H190/230 cm

 Fiberglass / Steel

 11,6 kg

 76 x Ø 23 cm



Cucinotto moderno realizzato con materiali leggeri.

CARATTERISTICHE:

- 3 finestre a zanzariera con copertura
- Entrata apribile a veranda
- Aerazione in sommità di cupola
- Balza perimetrale
- Completo di sacca custodia, pali verticali e accessori di montaggio

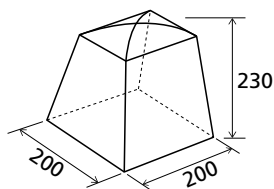

Spalmatura (PU)

Finestre con zanzariera

Finestre oscurabili

Ventilazione permanente

Numero entrate (1)

Balza perimetrale

Accessori di montaggio

Sacca custodia



Gancio portalanterna



Apertura antivento

I cucinotti hanno principalmente la funzione di una cucina mobile. Offrono anche numerosi vantaggi aggiuntivi che rendono il campeggio più facile e sono particolarmente apprezzati dalle famiglie:

- Più spazio e libertà di movimento nella veranda
- Nessun odore di cucina sgradevole nella veranda
- Ottima ventilazione
- Confortevole altezza interna
- Può essere usato anche come tenda Storage (si consiglia con catino)
- Perfetto per riporre in sicurezza biciclette, moto, grill o giocattoli per bambini
- Alcuni modelli sono disponibili con catino integrato o integrabile (vedi descrizione del prodotto)

Per coloro che apprezzano l'ordine e l'organizzazione consigliamo sempre l'utilizzo di un cucinotto o di una tenda Storage. La nostra gamma comprende una varietà di modelli e dimensioni progettati per diverse applicazioni. Leggere attentamente le descrizioni dei prodotti corrispondenti per selezionare il modello più adatto alle proprie esigenze.





DINERY

ART. 0425994N

€ TBC
1 / 1 / 18

 Polyester PU 100% Polyester

 240 x 240 x H190/230 cm

 Fiberglass / Steel

 13,3 kg

 70 x Ø 25 cm



Tenda multiuso per cucina ed attrezzatura con un robusto telaio in acciaio/fibra di vetro, grandi finestre e una porta d'ingresso ad avvolgimento. Con balza perimetrale. Sono inclusi il materiale di montaggio e la sacca custodia.

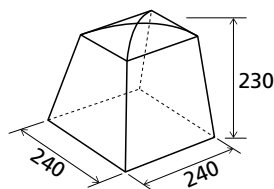

Spalmatura (PU)

Finestre Panorama

Finestre con zanzariera

Finestre oscurabili

Ventilazione permanente

Numero entrate (1)

Balza perimetrale

Accessori di montaggio

Sacca custodia

MIX & MATCH



TITANIUM AXIA
P. 178



CRUISER
P. 157



MERCURY CROSS COOKER
P. 198







VIDA



VIDA I NG

ART. 0425998N.C30

€ TBC
1 / 1 / 15



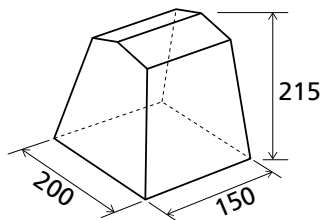

-  PVC / Polyester / Oxford
-  200 x 150 x H195/215 cm
-  Steel Ø 19 mm
-  13,5 kg
-  100 x 21 x 26 cm



VIDA II NG

ART. 0425999N.C30

€ TBC
1 / 1 / 15

-  PVC / Polyester / Oxford
-  200 x 200 x H195/215 cm
-  Steel Ø 19 mm
-  16,5 kg
-  100 x 21 x 26 cm

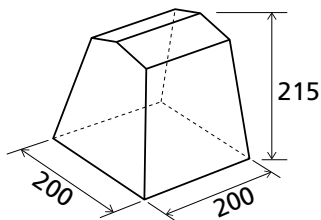

Spalmatura (PU)

Finestre Panorama

Finestre con zanzariera

Finestre oscurabili

Ventilazione permanente

Numero entrate (1)

Balza perimetrale

Accessori di montaggio

Sacca custodia

Cucinetto con classico tetto a falde.

CARATTERISTICHE:

- Porta d'entrata arrotolabile lateralmente
- 3 grandi finestre a zanzariera con copertura
- Apertura di aerazione
- Con balza rialzata
- Completo di sacca custodia e accessori di montaggio



Struttura in acciaio



Finestre con zanzariera







GUSTO

GUSTO I NG

ART. 0425995N

€ TBC
1/1/15

-  PVC / Polyester / Oxford PVC
-  150 x 150 x H195/215 cm
-  Steel Ø 19 mm
-  11,7 kg
-  100 x 21 x 25 cm

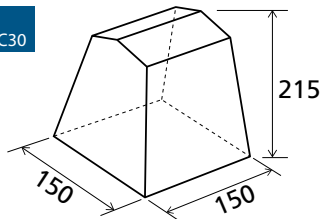
COLORS C25 C30

Cucinotto con classico tetto a falde.





CARATTERISTICHE:

- Finestre a zanzariera con copertura
- Balza perimetrale
- Con porta ingrandita e finestre supplementari entrata luce
- Completo di sacca custodia e accessori di montaggio

GUSTO II NG

ART. 0425996N

€ TBC
1/1/15



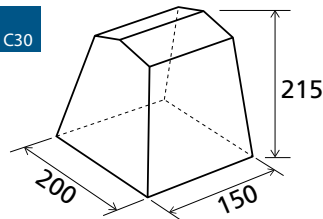

-  PVC / Polyester / Oxford PVC
-  200 x 150 x H195/215 cm
-  Steel Ø 19 mm
-  13,5 kg
-  100 x 21 x 26 cm

COLORS C25 C30

GUSTO III NG

ART. 0425997N

€ TBC
1/1/15

-  PVC / Polyester / Oxford PVC
-  200 x 200 x H195/215 cm
-  Steel Ø 19 mm
-  16,5 kg
-  100 x 21 x 26 cm

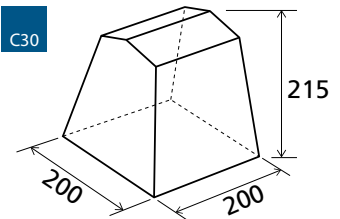
COLORS C25 C30

Spalmatura (PU)

Finestre Panorama

Finestre con zanzariera

Finestre oscurabili

Ventilazione permanente

Numero entrate (1)

Balza perimetrale

Accessori di montaggio

Sacca custodia



CAMP INN

CAMP INN

ART. 0426013N

€ TBC
1 / 1 / 12

PVC / Polyester / Oxford PVC

220 x 160 x H195/220 cm

Steel Ø 22 mm

19,5 kg

Moderno cucinotto multiuso. Design innovativo con tetto arcuato in poliestere spalmato su entrambi i lati (PVC).

CARATTERISTICHE:

- Pareti laterali e posteriori con grandi finestre di ventilazione in zanzariera con telo di copertura
- Parete anteriore con porta arrotolabile lateralmente
- Apertura di ventilazione permanente
- Con balza perimetrale
- Completo di sacca custodia e accessori di montaggio

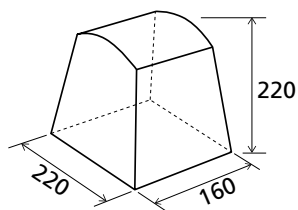

MIX & MATCH

Finestre Panorama

Finestre con zanzariera

Finestre oscurabili

Ventilazione permanente

Numero entrate (1)

Balza perimetrale

Accessori di montaggio

Sacca custodia



PIRATE
P. 268



DEVIL SD
P. 293



AZABACHE CT CROSS
SQUARE
P. 195







CORIANDER

CORIANDER I

ART. 0425991N.C06

€ TBC
1/1/12



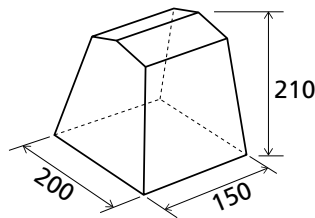

-  PVC
-  200 x 150 x H195/210 cm
-  Steel Ø 22 mm
-  20,5 kg



CORIANDER II

ART. 0425992N.C06

€ TBC
1/1/12

-  PVC
-  200 x 200 x H195/210 cm
-  Steel Ø 22 mm
-  23 kg

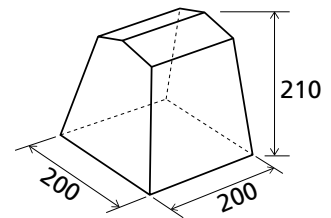

Finestre Panorama

Finestre con zanzariera

Finestre oscurabili

Ventilazione permanente

Numero entrate (1)

Balza perimetrale

Accessori di montaggio

Sacca custodia

Tenda multifunzione di nuova concezione. Funge perfettamente da tenda cucina e da ripostiglio per la protezione di tutte le attrezzature che non possono essere lasciate all'aperto. L'intera tenda è realizzata in PVC ed è sostenuta da un robusto telaio in acciaio. Tre grandi finestre con zanzariera e un'efficiente ventilazione del tetto garantiscono un'ottima aerazione. Con ampia porta d'ingresso arrotolabile lateralmente. Con balza perimetrale. Incl. accessori e sacca custodia.



CABINA II NG



Pratica tenda cabina per campeggio e spiaggia. Ideale per la doccia e cambiarsi, ma anche come tenda cucina.

CARATTERISTICHE:

- Porta con cerniera
- Grande finestra posteriore
- Balza perimetrale
- Con sacca custodia ed accessori di montaggio

- Spalmatura (PU)
- Finestre con zanzariera
- Finestre oscurabili
- Ventilazione permanente
- Numero entrate (1)
- Tasche interne

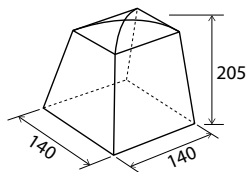

CABINA II NG

ART. 0102028N

€ TBC
4 / 4 / 80

- 100% Polyester
- 140 x 140 x H205 cm
- Fiberglass
- 2,65 kg
- 67 x Ø 23 cm

CABINA MAXI NG



Pratica tenda cabina per campeggio e spiaggia. Ideale per la doccia e cambiarsi, ma anche come tenda cucina.

CARATTERISTICHE:

- Porta con cerniera
- Grande finestra posteriore
- Balza perimetrale
- Con sacca custodia ed accessori di montaggio

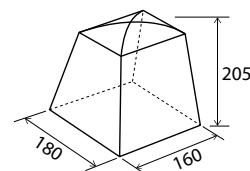

CABINA MAXI NG

ART. 0102029N

€ TBC
4 / 4 / 80

- 100% Polyester
- 180 x 160 x H205 cm
- Fiberglass
- 4 kg
- 70 x Ø 27 cm

- Spalmatura (PU)
- Finestre con zanzariera
- Finestre oscurabili
- Ventilazione permanente
- Numero entrate (1)
- Tasche interne





STORAGE PLUS



STORAGE PLUS

ART. 0426044N.C06

€ TBC
1 / 1 / 12

-  PVC / Oxford Polyester
-  225 x 160 x H175/195 cm
-  Steel Ø 19 mm
-  13,9 kg
-  94,5 x 22 x 28 cm

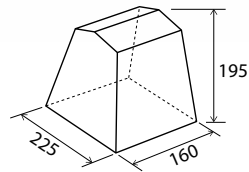

- Spalmatura (PU)
- Finestre oscurabili
- Numero entrate (1)

Catino cucito

Tasche interne

Accessori di montaggio

Sacca custodia

Pratica tenda per attrezzi con tetto a 2 falde, ideale per il campeggiatore ben accessorio. Robusta, con catino saldamente cucito. L'ampia porta d'ingresso sul lato anteriore può essere comodamente aperta tramite due cerniere e, se necessario, essere aperta come tettuccio parasole. La parete posteriore è dotata di un'ampia finestra a zanzariera che può essere chiusa mediante una pellicola in Crystal. 3 aperture di ventilazione sulla parete anteriore e laterali garantiscono una sufficiente circolazione dell'aria all'interno della tenda. Materiale di montaggio incluso.

SANITY



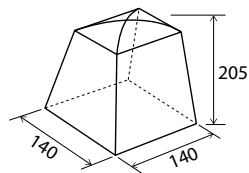

Tenda sanitaria versatile e polivalente con pali stabili in acciaio, pavimento rimovibile e finestra di zanzariera richiudibile. Sono comprese varie soluzioni funzionali ed una pratica borsa da trasporto.



SANITY

ART. 0102025N

€ TBC
2 / 4 / 32

-  68D Polyester PU (100% Polyester)
-  140 x 140 x H205 cm
-  Steel Ø 16 mm
-  6 kg
-  80 x 41 cm

Spalmatura (PU)

Finestre con zanzariera

Finestre oscurabili

Ventilazione permanente

Numero entrate (1)

Tasche interne

Accessori di montaggio

Sacca custodia





AUTO-UP SYSTEM

Il sistema di gonfiaggio integrato A.I.S. per tende, verande e gazebo dotati di strutture ad aria rappresenta una vera rivoluzione del settore. Immagina un montaggio rapido, senza sforzo ed estremamente confortevole. Dimentica le pompe ad aria manuali o i compressori elettrici da trasportare. Grazie alla batteria ricaricabile LiOn, sarai libero di goderti l'esperienza senza pensieri. Con A.I.S., potrai preparare il tuo rifugio in pochi minuti, consentendoti più tempo per rilassarti e goderti la tua avventura. Che tu sia un campeggiatore esperto o un principiante, A.I.S. renderà la tua vita Outdoor più semplice e pratica che mai. Scegli l'innovazione, scegli A.I.S.!



AQUAMAR 250 AUTO-UP

Il nostro nuovissimo gazebo esterno e da spiaggia Aquamar, dotato di un sistema di gonfiaggio automatico integrato, sta per rivoluzionare il modo in cui allestisci il tuo spazio all'aperto. Con una capacità di gonfiaggio rapido e senza sforzo, il montaggio del gazebo diventa estremamente facile e confortevole. Goditi il lusso di non dover più preoccuparti di pompe o compressori, poiché il nostro sistema di gonfiaggio integrato farà tutto il lavoro per te. Con il suo design resistente, il gazebo Aquamar offre un'ampia area coperta per ripararti dal sole estivo o creare un ambiente accogliente per i tuoi eventi all'aperto. Scegli il futuro del comfort e dell'eleganza con il gazebo Aquamar.



AQUAMAR 250 AUTO-UP

ART. 0102002N

€ TBC
1 / 1 / -

150D Polyester PU

AIRTUBE

250 x 250 x H165/220 cm

8,7 kg

70 x Ø 21 cm



OPTIONAL



AQUAMAR 250 SIDEWALL SET

ART. 0102003N

€ TBC
2 / 10 / -

100% Polyester

Set di due pareti laterali per gazebo Aquamar 250.



100%
Polyester
190T

a.i.r.
tech
air inflation raising

AQUAMAR

AQUAMAR

ART. 0102004N.C70

€ TBC
1 / 1 / 16

 190T Polyester 75D Polyester PU

 AIRTUBE

 300 x 300 x H190/220 cm

 13,6 kg

 75 x Ø 29 cm

Gazebo outdoor gonfiabile realizzato con tecnologia Crossbeam.

CARATTERISTICHE:

- Semplice e rapido da montare e smontare
- Aste di stabilizzazione sui 4 lati
- Altezza interna 2 metri
- Pompa a doppia azione inclusa
- Sacca custodia inclusa
- Accessori di montaggio inclusi
- Set pareti laterali (2 pz.) disponibile come optional



VIDEO

OPTIONAL



AQUAMAR SIDEWALL SET

ART. 0102015N.C70

€ TBC
2 / 10 / -

 100% Polyester

Set di due pareti laterali per gazebo Aquamar.

100%
Polyester
190T



INFO



PROTEZIONE DAL SOLE

È arrivata l'ora del divertimento al sole ed all'aria aperta. Divertimento da affrontare sempre in sicurezza e ben protetti dai potenzialmente pericolosi raggi UV. Sia che vi stiate godendo una giornata di sole in giardino o a bordo piscina o sulla spiaggia, i prodotti per la protezione dal sole Brunner sono gli accessori giusti da usare. Progettati per essere leggeri e facilmente trasportabili, quasi tutti vantano un fattore di protezione UV 50+ ideale per mantenere la pelle fresca e ben protetta. Brunner è da sempre sinonimo di design funzionale ed innovazione creativa. Tutti i prodotti vengono sviluppati e realizzati con la passione per una vita da trascorrere all'aria aperta. Il nostro obiettivo è sempre quello di offrire attrezzatura di elevata qualità che combini il meglio della convenienza, della funzionalità e del design, per fornire una protezione efficace dal sole, dal vento o dalla pioggia.

**MIX&
MATCH**



CAREZZA
P. 273



ACCELERATE COMPACT
P. 177



RAPTOR COMPACT
P. 157



POLARYS TRAVEL
P. 333



OCEANA

OCEANA

ART. 0102013N

€ TBC
1 / 1 / 25

 190T 68D PU / Silver PU2000 mm

 Fiberglass

 300 x 300 x H220 cm

 9,2 kg

 78 x Ø 18 cm



L'Oceana è un gazebo outdoor di nuova concezione, di grande impatto visivo e di ottima stabilità. E' ideale per qualsiasi incontro di gruppo, dal minibus camping, al soggiorno in spiaggia, al barbecue in giardino. La speciale forma del tetto protegge dal sole e dalla pioggia anche tutta l'attrezzatura. L'Oceana viene fornito con tutto il necessario per il suo utilizzo: pali in fibra di vetro, picchetti, corde tensione ed una sacca custodia. Sono incluse 2 pareti laterali. La stuoia per il pavimento è opzionale.



Gancio portalanterna



Apertura antivento



OPTIONAL

OCEANA SIDEWALL SET

ART. 0102014N

€ TBC
2 / 10 / -

 300 x 300 cm

Set di pareti laterali (2 pz.) per gazebo outdoor Oceana. Con borsa per il trasporto.



MEDUSA II



MEDUSA II 3X3

ART. 0102034N

€ TBC
1 / 1 / 25

 68D Polyester PU 100% Polyester

 Fiberglass / Steel

 300 x 300 x H190/230 cm

 10 kg

 62 x Ø 23 cm

100% Polyester
68D Polyester PU



COLORS

C30

C70

Gazebo per outdoor con paleria esterna in acciaio e fibra di vetro. Completo di due pareti laterali staccabili.

OPTIONAL



MEDUSA SIDEWALL SET 300

ART. 0102057N

€ TBC
2 / 10 / 240

 100% Polyester

 300 x H178 cm

Set di due pareti laterali per gazebo Medusa.

INFO

IL FATTORE DI
PROTEZIONE UV

Il fattore di protezione indica il livello di protezione UV dei vari tessuti. Esistono numerose similitudini con il sistema SPF che indica il livello di protezione di creme solari. Tessuti con un fattore di protezione UV 50+ permettono il passaggio di appena 1/50 della radiazione. Ciò significa che il 98% dei raggi UV viene bloccato.



MEDUSA II 4X4

ART. 0102030N

€ TBC
1 / 1 / 25

68D Polyester PU 100% Polyester

Fiberglass / Steel

400 x 400 x H190/230 cm

12,2 kg

69 x Ø 25 cm

100%
Polyester
68D
Polyester PU



COLORS



Gazebo Outdoor con paleria esterna in acciaio e fibra di vetro.
Completo di due pareti laterali staccabili.

OPTIONAL



MEDUSA SIDEWALL SET 400

ART. 0102055N

€ TBC
2 / 10 / -

100% Polyester

400 x H178 cm

Set di due pareti laterali per gazebo Medusa.



SUNTOP

ART. 0113049N

€ TBC

3 / 9 / 180

 100% Polyester

 Fiberglass

 250/150 x 190 x H150 cm

 1,68 kg

 63 x Ø 12 cm

Conchiglia parasole di grandi dimensioni.

CARATTERISTICHE:

- Unisce i vantaggi di una conchiglia parasole con quelli di un ombrellone
- Le pareti laterali rialzate garantiscono una buona ventilazione
- Montaggio e smontaggio semplici e rapidi
- Con pratica borsa per il trasporto



TONGA

TONGA

ART. 0113016N

€ TBC

6 / 6 / 252

 100% Polyester

 PE

 Fiberglass

 240 x 110 x H155 cm

 1,35 kg

 53 x Ø 9 cm



Conchiglia parasole che protegge da vento, sabbia e sguardi indiscreti. Catino fissato mediante cucitura. Sacca custodia inclusa.



360°



BAYOU

ART. 0113039N

€ TBC
5 / 10 / 80

100% Polyester

PE

Fiberglass

245 x 150 x H100 cm

1,2 kg

2 x Ø 75 cm

3 SIDES WITH MESH



Conchiglia parasole con sistema Pop Up. Offre spazio sufficiente per 2 persone. Gli accessori di montaggio sono inclusi.

UMBRA

ART. 0113040N

€ TBC
6 / 6 / 96

100% Polyester

PE

Fiberglass

200 x 150 x H130 cm

1,9 kg

59 x Ø 12 cm



Moderna conchiglia parasole con spazio per 2-3 persone. Con accessori di montaggio e sacca custodia.

SUNNY UV



					€ TBC	M.O.	Master		
ART. 0113055N	100% Polyester	Steel Ø 19 mm	2 x 3 m	1,84 kg	€ TBC	2	10	100	
ART. 0113056N	100% Polyester	Steel Ø 19 mm	3 x 3 m	2,02 kg	€ TBC	2	10	100	
ART. 0113057N	100% Polyester	Steel Ø 19 mm	3 x 4 m	2,30 kg	€ TBC	2	10	100	



Utilissima vela parasole con numerose varianti di montaggio. La fornitura comprende 2 pali verticali in acciaio.



OUTPOST

NEW
2025

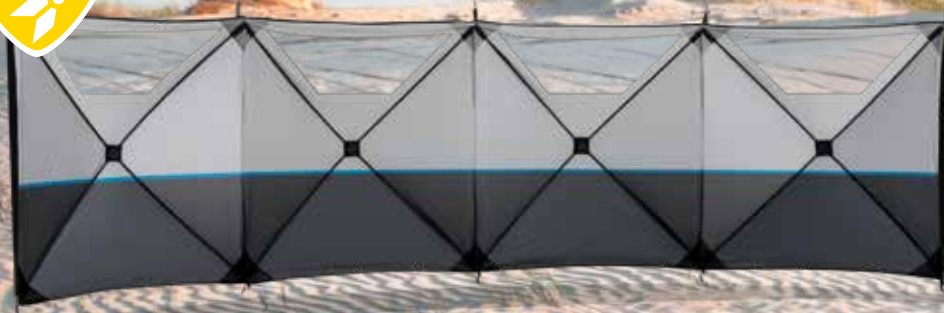

LAOLA



OUTPOST

ART. 0113054N

-  500 x 125 cm
-  H105 x 15 cm
-  8,1 kg
-  150D Oxford PES

€ TBC
1 / 2 / -





Il paravento Outpost è un prodotto innovativo che offre una soluzione pratica ed efficiente per la protezione dal vento e dalla privacy. Il suo sistema di pali integrato consente un'installazione facile e veloce: ognuno dei quattro pannelli è dotato di una cerniera centrale che permette di aprire e chiudere il paravento come un ombrello. I pali verticali in acciaio assicurano un elevato grado di stabilità, in modo che il paravento rimanga in posizione verticale e sicura anche quando è completamente aperto. Questa soluzione progettuale elimina la necessità di un lungo montaggio, poiché i pali e i picchetti possono essere montati senza doversi preoccupare che il paravento si ribalti. Il design innovativo del paravento Outpost lo rende una scelta affidabile e facile da usare per le aree esterne in cui è importante la protezione dal vento o dalla privacy.

CARATTERISTICHE:

- Montaggio semplice grazie al telaio Easy-Up
- Elevata stabilità
- I pannelli possono essere inclinati in qualsiasi direzione per consentire di ottenere forme diverse quando vengono montati
- Include pali di montaggio e tiranti

LAOLA

ART. 0113047N

-  H115 x 400/520 cm
-  64 x Ø 11 cm
-  1,6 kg
-  100% Polyester

€ TBC
4 / 8 / 160

Paravento da spiaggia. Sono compresi picchetti, corde tensione ed una sacca custodia.

PANAMA

BAHAMA

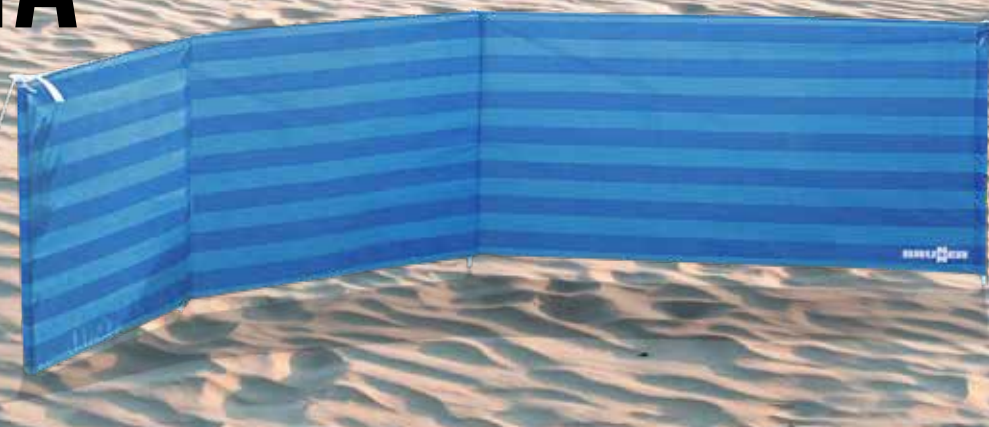

PANAMA SKY

ART. 0113058N.C30

€ TBC
4 / 4 / 80
 H140 x 400 cm

 84 x 20 cm

 2,5 kg

 100% PE

Telo paravento con finestrella panoramica in plastica trasparente.

BAHAMA TNT

ART. 0113048N

€ TBC
6 / 12 / 120
 H110 x 480 cm

 H118 x 18 cm

 1,1 kg

 TNT

Paravento da spiaggia dai colori vivaci. Viene fornito con materiale di montaggio ed una pratica sacca custodia.

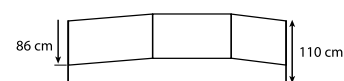



GAZEBOS & BEACH PARASOLS

GAZEBI AUTOMATICI
OMBRELLONI



ZEBÒ COLLECTION

COLLECTION	ZEBÒ ENJOY 2.0	ZEBÒ ENJOY PRO
Struttura pieghevole automatica	•	•
Struttura ad innesto	-	-
Struttura in acciaio	•	-
Struttura in alluminio	-	•
Palo tetto centrale	•	•
Struttura regolabile in altezza	•	•
Componenti struttura avvitati	•	•
Snodi rinforzati	•	•
Tessuto tetto in poliesteri	•	•
Tessuto tetto in PE	-	-
Cuciture nastrate	•	•
Punti di contatto tetto/struttura rinforzati	•	•
Spalmatura tetto in PVC	•	•
Varianti colore	1	1
Pareti laterali optional	•	•
Accessori di montaggio inclusi	•	•

Gazebo pieghevoli Zebò per il tempo libero, per il camping, per gli eventi e per la vendita.

Da oltre 20 anni la nostra gamma di prodotti comprende gazebo pieghevoli di alta qualità per le più svariate attività. In questo lasso di tempo, il nostro team di sviluppo prodotto ha sempre cercato di migliorare i materiali e la relativa produzione. Tutti i materiali sono accuratamente selezionati e testati in condizioni reali per soddisfare le aspettative del cliente e garantire l'affidabilità e la durata desiderata.

I gazebo pieghevoli Zebò sono particolarmente apprezzati nel settore del tempo libero e del campeggio, ma sono anche ideali per eventi, presentazioni o feste.

Sono facili e veloci da montare e smontare e possono essere riposti in modo compatto e comodamente trasportati. Importante: tutti i componenti sono avvitati insieme per facilitarne la manutenzione e possono quindi essere facilmente sostituiti.

La collezione di gazebo pieghevoli Zebò comprende i seguenti modelli:

- Zebò Enjoy 2.0 - Robusti gazebo pieghevoli con telaio in acciaio verniciato a polvere (profilo rettangolare 40x40 mm). Disponibile in 3 misure.

- Zebò Enjoy PRO - Gazebo PRO pieghevole in alluminio di alta qualità, con struttura a profilo esagonale da 50 mm. Disponibile in 3 misure.





Cinghia di fissaggio



Gambe regolabili in altezza

Pratico gazebo automatico con palo centrale per una massima inclinazione del tetto che favorisce il deflusso dell'acqua. Stabile struttura in profili di acciaio verniciato a polvere con gambe regolabili in altezza. Tetto realizzato in 100% poliestere a spalmatura impermeabile. Cuciture nastrate. La fornitura comprende una pratica borsa per il trasporto munita di ruote. Sono inclusi tiranti e picchetti. Montaggio e smontaggio semplice e rapido. Campi d'utilizzo: Camping, feste ed eventi, fiere.

CARATTERISTICHE:

- Tipo struttura: automatica-pieghevole
- Gambe: in acciaio verniciato a polvere 40x40 mm, regolabili in altezza
- Tutti i componenti sono avvitati e sostituibili



POLES
40
MM

steel
Acciaio



Snodi di alta qualità







Nastro premi e chiudi per fissaggio pareti

ZEBÒ ENJOY 2.0

ZEBÒ ENJOY 2.0 3X3

ART. 0102211N.C00

€ TBC
1/1/12





-  3 x 3 x 2,10/3,35 m
-  155 x 24 x 24 cm
-  100% Polyester / PVC 290 g/m2
-  40x40/35x35/15x30 mm
-  25,5 kg



ZEBÒ ENJOY 2.0 3X4,5

ART. 0102212N.C00

€ TBC
1/1/9





-  3 x 4,5 x 2,10/3,35 m
-  155 x 32 x 22 cm
-  100% Polyester / PVC 290 g/m2
-  40x40/35x35/15x30 mm
-  32,2 kg



ZEBÒ ENJOY 2.0 3X6

ART. 0102213N.C00

€ TBC
1/1/7

-  3 x 6 x 2,10/3,35 m
-  155 x 42 x 22 cm
-  100% Polyester / PVC 290 g/m2
-  40x40/35x35/15x30 mm
-  43,7 kg



OPTIONAL

SIDEWALL SET ZEBÒ ENJOY 2.0

Utilissimo set di pareti laterali per gazebo pieghevoli ZEBÒ ENJOY 2.0. Le pareti laterali completano ogni gazebo pieghevole e lo rendono resistente alle intemperie e al vento. Tutte le pareti laterali vengono semplicemente fissate all'interno del bordo del gazebo tramite nastro premi e strappa già predisposto e collegabili mediante l'ausilio di cerniere. Nella fornitura è compresa una borsa custodia.

ART. 0102215N.C00

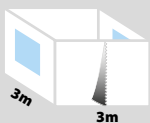

3m 3m

ART. 0102216N.C00

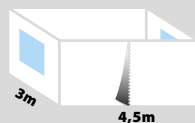

3m 4,5m

ART. 0102217N.C00

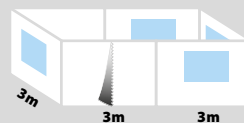

3m 3m 3m



M.O.

Master



ART. 0102215N.C00	3 x 3 m	210 PU Polyester	8,5 kg	€ TBC	1	4	-
ART. 0102216N.C00	3 x 4,5 m	210 PU Polyester	10,6 kg	€ TBC	1	4	-
ART. 0102217N.C00	3 x 6 m	210 PU Polyester	12,8 kg	€ TBC	1	4	-





ZEBÒ ENJOY PRO



ZEBÒ ENJOY PRO 3X3

ART. 0102221N.C00

€ TBC
1/1/12

3 x 3 x 2,10/3,35 m

158 x 25 x 25 cm

100% Polyester / PVC 290 g/m2

50/45/32x16 mm

22,5 kg



ZEBÒ ENJOY PRO 3X4,5

ART. 0102222N.C00

€ TBC
1/1/9

3 x 4,5 x 2,10/3,35 m

158 x 32 x 24 cm

100% Polyester / PVC 290 g/m2

50/45/32x16 mm

28,7 kg



ZEBÒ ENJOY PRO 3X6

ART. 0102223N.C00

€ TBC
1/1/7

3 x 6 x 2,10/3,35 m

158 x 42 x 24 cm

100% Polyester / PVC 290 g/m2

50/45/32x16 mm

38,2 kg



Snodi di alta qualità

Cinghia di fissaggio

Gazebo automatico semiprofessionale con struttura esagonale di alta qualità. Dotato di palo centrale per una massima inclinazione del tetto che favorisce il deflusso dell'acqua. Struttura molto stabile in alluminio con gambe regolabili in altezza. Tetto realizzato in 100% poliestere a spalmatura impermeabile. Cuciture nastrate. La fornitura comprende una pratica borsa per il trasporto munita di ruote. Sono inclusi tiranti e picchetti. Montaggio e smontaggio semplice e rapido. Campi d'utilizzo: Feste ed eventi, mercatini, fiere.

CARATTERISTICHE:

- Tipo struttura: automatica-pieghevole
- Gambe: in alluminio 50 mm, regolabili in altezza
- Spessore profili: gambe 2,0 mm - tetto 2,0 mm
- Tutti i componenti sono avvitati e sostituibili



BASE

ART. 0303064N

€ TBC
8 / 16 / 48

Ø 25 cm

1,3 kg

Base stabilizzante in materiale plastico. Per gazebo con gambe da Ø 25 a 32 mm. Viene fornita in coppia.



BALLAST NG

ART. 0303078N

€ TBC
1/1/-

10 kg

Zavorra in ghisa per la stabilizzazione delle singole gambe dei gazebo. Con cinghia di fissaggio. Adatto per profili fino a 40x40 mm.

COLORS C34 C00

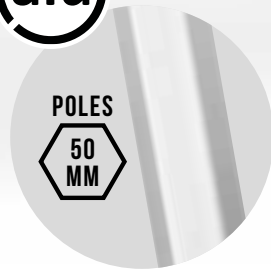

Nastro premi e chiudi per fissaggio pareti

Gambe regolabili in altezza



OPTIONAL

SIDEWALL SET ZEBÒ ENJOY PRO

Utilissimo set di pareti laterali per gazebo pieghevoli ZEBÒ ENJOY PRO. Le pareti laterali completano ogni gazebo pieghevole e lo rendono resistente alle intemperie e al vento. Tutte le pareti laterali vengono semplicemente fissate all'interno del bordo del gazebo tramite nastro premi e strappa già predisposto e collegabili mediante l'ausilio di cerniere. Nella fornitura è compresa una borsa custodia.

ART. 0102218N.C00

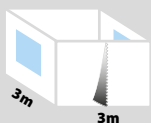

ART. 0102219N.C00

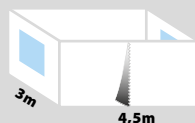

ART. 0102220N.C00

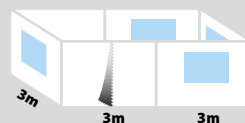

M.O.



ART. 0102218N.C00	3 x 3 m	210 PU Polyester	8,5 kg	€ TBC	1	4	-
ART. 0102219N.C00	3 x 4,5 m	210 PU Polyester	10,6 kg	€ TBC	1	4	-
ART. 0102220N.C00	3 x 6 m	210 PU Polyester	12,8 kg	€ TBC	1	4	-



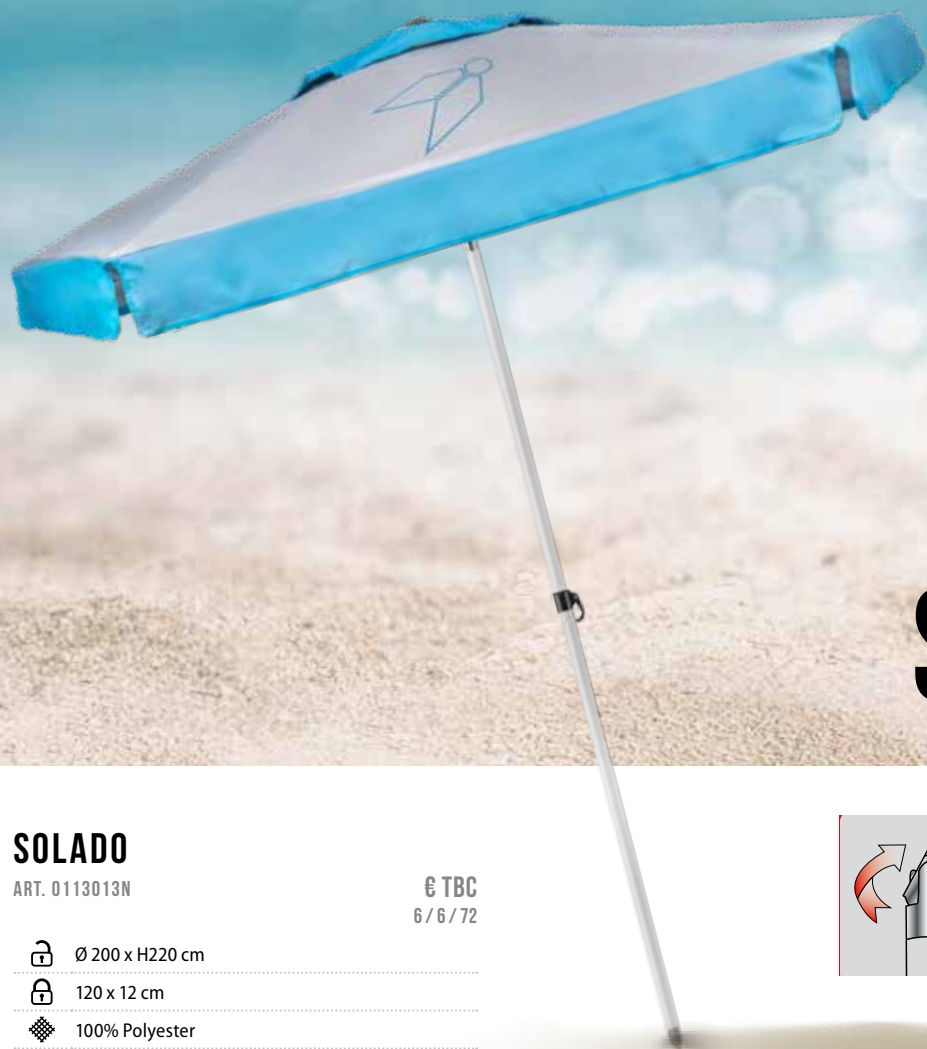

SOLADO

SOLADO

ART. 0113013N

€ TBC
6 / 6 / 72

Ø 200 x H220 cm

120 x 12 cm

100% Polyester

2,52 kg

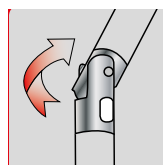

Moderno ombrellone da sole e da spiaggia di dimensioni compatte. Dotato di stelo in alluminio e di un robusto telo resistente ai raggi UV. I passanti aggiuntivi alle estremità dei raggi dell'ombrellone permettono l'ancoraggio contro il forte vento. Nella parte inferiore dell'ombrellone ci sono 2 ganci e una pratica rete per gli utensili. Grazie all'inclinazione laterale regolabile, questo ombrellone offre la migliore protezione solare in qualsiasi momento della giornata. Borsa per il trasporto inclusa.



INFO

PROTEZIONE DAL SOLE

È arrivata l'ora del divertimento al sole ed all'aria aperta. Divertimento da affrontare sempre in sicurezza e ben protetti dai potenzialmente pericolosi raggi UV. Sia che vi stiate godendo una giornata di sole in giardino o a bordo piscina o sulla spiaggia, i prodotti per la protezione dal sole Brunner sono gli accessori giusti da usare. Progettati per essere leggeri e facilmente trasportabili, quasi tutti vantano un fattore di protezione UV 50+ ideale per mantenere la pelle fresca e ben protetta. Brunner è da sempre sinonimo di design funzionale ed innovazione creativa. Tutti i prodotti vengono sviluppati e realizzati con la passione per una vita da trascorrere all'aria aperta. Il nostro obiettivo è sempre quello di offrire attrezzatura di elevata qualità che combini il meglio della convenienza, della funzionalità e del design, per fornire una protezione efficace dal sole, dal vento o dalla pioggia.



ONDA PARSOL





ONDA PARSOL

ART. 0113017N

€ TBC
6 / 6 / 108

 205/200 x H220 cm

 123 x 13 cm

 Polyester 180g

 2 kg

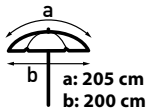
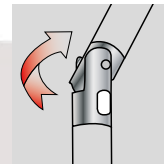

Moderno ombrellone realizzato in resistente tessuto sintetico e struttura molto stabile a 6 raggi. Stelo molto robusto in acciaio verniciato a polvere Ø 32 mm con snodo in alluminio e puntale a vite per terreni sabbiosi. Ottima resistenza al vento grazie al soffietto di scarico integrato. Con borsa per il trasporto.



IL FATTORE DI PROTEZIONE UV

Il fattore di protezione indica il livello di protezione UV dei vari tessuti. Esistono numerose similitudini con il sistema SPF che indica il livello di protezione di creme solari. Tessuti con un fattore di protezione UV 50+ permettono il passaggio di appena 1/50 della radiazione. Ciò significa che il 98% dei raggi UV viene bloccato.

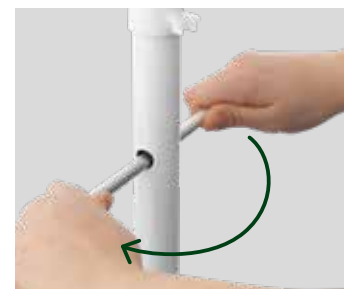

BEACH PARSOL XL



**NEW
2025**

BEACH PARSOL XL

ART. 0113010N.C28

€ TBC
6 / 6 / 120

Ø 175 x H160 cm

100% Polyester

Alu / Fiberglass

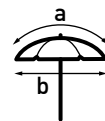

a: 195 cm
b: 175 cm

Ombrellone predisposto per l'applicazione di pareti laterali che lo trasformano in una praticissima conchiglia parasole.



SUN PARSOL



**NEW
2025**

SUN PARSOL

ART. 0113026N.C9N

€ TBC
6 / 6 / 120

Ø 200/190 x H198 cm

Ø 9 x H107 cm

100% PES

1,8 kg

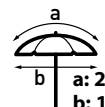

a: 200 cm
b: 190 cm

Ombrellone di alta qualità da giardino e spiaggia.



PARSOL RIDE2SEA

PARSOL RIDE2SEA

ART. 0113028N

€ TBC
6 / 6 / -

Il Parsol Ride2Sea è l'ombrellone che vi accompagna ovunque. Una volta smontato, non è più lungo di 64 cm e può essere riposto nella sua borsa. Ideale per il trasporto in bicicletta, scooter o moto. Resistente e realizzato con materiali di alta qualità.

-  Ø 180/160 x H190 cm

-  64 x 20 x 7 cm

-  Polyester / Alu

-  1,48 kg

-  Steel Ø 28/25 mm

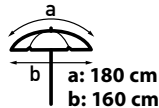

RIO

ART. 0303043N

€ TBC
12 / 48 / -

 39 cm x Ø 13/33 mm

Picchetto portaombrelloni realizzato in robusto materiale plastico. Con adattatore per steli da 13 a 33 mm.



DRILLER

ART. 0303044N

 32,5 cm x Ø 13/33 mm

Picchetto portaombrelloni avvitabile per terreni sabbiosi. Con manico e vite di fissaggio per l'ombrellone. Realizzato in resistente materiale plastico.



WAIKIKI BASIC

ART. 0303046N

€ TBC
10 / 20 / 360

 45 cm Ø tube 36 mm

Picchetto portaombrelloni in acciaio zincato.



CAMPING ACCESSORIES

**PALERIA ED ACCESSORI TENDE
TELONI ED ACCESSORI**





PER TERRENI DURI

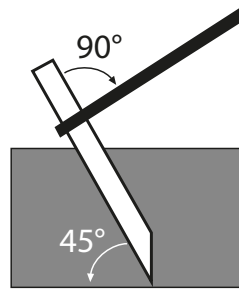

PEG BOX

INFO P. 87

steel
Acciaio



INFO

PICCHETTI

La maggior parte delle tende in commercio viene offerta con picchetti standard. In modo che la vostra tenda si possa fissare adeguatamente su ogni tipo di suolo e con ogni condizione meteorologica è sempre consigliato adattare l'assortimento di picchetti.



TEMPEST



PACK

M.O.

Master



ART. 0303010C	20 cm	6X	€ TBC	20	60	-
ART. 0303010N	20 cm		€ TBC	100	100	-
ART. 0303011C	25 cm	6X	€ TBC	20	60	-
ART. 0303011N	25 cm		€ TBC	100	100	-
ART. 0303012C	30 cm	6X	€ TBC	20	60	-
ART. 0303012N	30 cm		€ TBC	100	100	-

Picchetto in acciaio zincato.



made in EU

THOR



PACK

M.O.

Master



ART. 0303028C	18 cm	5X	€ TBC	10	50	-
ART. 0303028N	18 cm		€ TBC	100	100	-
ART. 0303029C	23 cm	5X	€ TBC	10	50	-
ART. 0303029N	23 cm		€ TBC	100	100	-
ART. 0303030C	27 cm	5X	€ TBC	10	50	-
ART. 0303030N	27 cm		€ TBC	100	100	-

Picchetto in acciaio zincato.



made in EU

DRAGON



PACK

M.O.

Master



ART. 0303035C	20 cm	6X	€ TBC	10	50	-
ART. 0303035N	20 cm		€ TBC	100	100	-
ART. 0303036C	25 cm	6X	€ TBC	10	50	-
ART. 0303036N	25 cm		€ TBC	100	100	-
ART. 0303037C	30 cm	6X	€ TBC	10	50	-
ART. 0303037N	30 cm		€ TBC	100	100	-

Picchetto speciale in ABS.

STAKE SET

ART. 0303033N

€ TBC
6 / 12 / 240



Pratico set picchetti per camping e veicoli ricreazionali. Confezionato in contenitore di plastica.

IL SET CONTIENE:

- 20 robusti picchetti in plastica da 23 cm per terreni erbosi e sabbiosi
- 10 picchetti per stuoia da 8 cm
- Attrezzo levapicchetti con manico rivestito

PER TERRENI MISTI



SQUARE

		PACK	€ TBC	M.O.	Master	
ART. 0302010C	22 cm x Ø 8 mm	4X	€ TBC	20	60	-
ART. 0302010N	22 cm x Ø 8 mm		€ TBC	100	100	-
ART. 0302012C	30 cm x Ø 8 mm	4X	€ TBC	20	60	-
ART. 0302012N	30 cm x Ø 8 mm		€ TBC	100	100	-

Picchetto speciale quadrato per terreni duri. Acciaio zincato.



STICK

		PACK	€ TBC	M.O.	Master	
ART. 0302017C	20 cm x Ø 6 mm	4X	€ TBC	20	20	-
ART. 0302017N	20 cm x Ø 6 mm		€ TBC	100	100	-
ART. 0302018C	25 cm x Ø 6 mm	4X	€ TBC	20	20	-
ART. 0302018N	25 cm x Ø 6 mm		€ TBC	100	100	-

Spillone chiodo, in acciaio zincato.



SQUARE TWISTED

		PACK	€ TBC	M.O.	Master	
ART. 0302014C	22 cm	4X	€ TBC	20	60	-
ART. 0302014N	22 cm		€ TBC	100	100	-
ART. 0302015C	30 cm	4X	€ TBC	20	60	-
ART. 0302015N	30 cm		€ TBC	100	100	-

 I picchetti Twisted sono realizzati in alluminio e garantiscono una maggiore tenuta nel terreno grazie alla loro ritorcitura.



STICK PLUS

		PACK	€ TBC	M.O.	Master	
ART. 0303014C	23 cm x Ø 8 mm	4X	€ TBC	20	20	-
ART. 0303014N	23 cm x Ø 8 mm		€ TBC	50	50	-
ART. 0303015C	25 cm x Ø 8 mm	4X	€ TBC	20	60	-
ART. 0303015N	25 cm x Ø 8 mm		€ TBC	50	50	-



GLOW Spillone chiodo rotondo con gancio in plastica, in acciaio zincato.



QUADRA

		PACK	€ TBC	M.O.	Master	
ART. 0302003C	18 cm x 5x5 mm	6X	€ TBC	20	60	-
ART. 0302003N	18 cm x 5x5 mm		€ TBC	100	100	-

Spillone quadrato, in acciaio zincato.



HEXA

		PACK	€ TBC	M.O.	Master	
ART. 0303032C	22 cm x Ø 8 mm	4X	€ TBC	20	60	-
ART. 0303032N	22 cm x Ø 8 mm		€ TBC	100	100	-
ART. 0303034C	30 cm x Ø 8 mm	4X	€ TBC	20	60	-
ART. 0303034N	30 cm x Ø 8 mm		€ TBC	100	100	-

Picchetto speciale per terreni duri. Acciaio zincato.



LINE

		PACK	€ TBC	M.O.	Master	
ART. 0302019C	18 cm x Ø 5 mm	6X	€ TBC	20	20	-
ART. 0302019N	18 cm x Ø 5 mm		€ TBC	100	100	-
ART. 0302020C	23 cm x Ø 5 mm	6X	€ TBC	20	20	-
ART. 0302020N	23 cm x Ø 5 mm		€ TBC	100	100	-
ART. 0302021C	28 cm x Ø 5 mm	6X	€ TBC	20	60	-
ART. 0302021N	28 cm x Ø 5 mm		€ TBC	100	100	-

Spillone rotondo, in acciaio zincato.



MATRIX

		PACK	€ TBC	M.O.	Master	
ART. 0303038C	30 cm	2X	€ TBC	10	50	-
ART. 0303038N	30 cm		€ TBC	50	50	-
ART. 0303039C	40 cm	2X	€ TBC	10	50	-
ART. 0303039N	40 cm		€ TBC	50	50	-
ART. 0303040C	50 cm	2X	€ TBC	10	50	-
ART. 0303040N	50 cm		€ TBC	50	50	-

Picchetto a T in acciaio zincato, molto robusto.

PER TERRENI DURI





TURCAL



PACK

M.O.

Master

ART.	Length	PACK	€ TBC	M.O.	Master	
ART. 0303005C	22 cm	6X	€ TBC	20	60	-
ART. 0303005N	22 cm		€ TBC	100	100	-
ART. 0303003C	26 cm	6X	€ TBC	20	60	-
ART. 0303003N	26 cm		€ TBC	100	100	-

Picchetto in acciaio zincato.



STABILIZER 38



PACK

M.O.

Master

ART.	Length	PACK	€ TBC	M.O.	Master	
ART. 0301313C	38 cm	2X	€ TBC	6	12	-
ART. 0301313N	38 cm		€ TBC	50	50	-

Picchetto in lamiera d'acciaio da 2 mm per terreni misti.



SANDLOCK



PACK

M.O.

Master

ART.	Length	PACK	€ TBC	M.O.	Master	
ART. 0303023C	31 cm	2X	€ TBC	10	50	-
ART. 0303023N	31 cm		€ TBC	50	200	-

Picchetto in alluminio per terreni sabbiosi o innevati.



RIO

ART. 0303043N



€ TBC
12 / 48 / -

39 cm x Ø 13/33 mm

Picchetto portaombrelloni realizzato in robusto materiale plastico. Con adattatore per steli da 13 a 33 mm.



DRILLER

ART. 0303044N

€ TBC
10 / 20 / 360

32,5 cm x Ø 13/33 mm

Picchetto portaombrelloni avvitabile per terreni sabbiosi. Con manico e vite di fissaggio per l'ombrellone. Realizzato in resistente materiale plastico.



WAIKIKI BASIC

ART. 0303046N

€ TBC
10 / 20 / -

45 cm Ø tube 36 mm

Picchetto portaombrelloni in acciaio zincato.



ELIX

ART. 0303066N

€ TBC
10 / 50 / -

42 cm x Ø 8 mm

Picchetto di ancoraggio in acciaio zincato, con anello di fissaggio.

PER TERRENI MORBIDI E SABBIOSI

PEG BOX

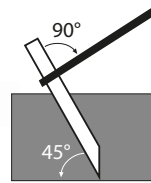

steel
Acciaio



PEG BOX STICK 20

ART. 0303067N

€ TBC
10 / 10 / -
 20 cm x Ø 6 mm

PACK 20X

 26 x 8 x 17 cm

Spillone chiodo, in acciaio zincato.



PEG BOX STICK 25

ART. 0303068N

€ TBC
10 / 10 / -
 25 cm x Ø 6 mm

PACK 20X

 26 x 8 x 17 cm

Spillone chiodo, in acciaio zincato.



PEG BOX SQUARE 22

ART. 0303071N

€ TBC
10 / 20 / -
 22 cm x Ø 8 mm

PACK 20X

 26 x 8 x 17 cm
Picchetto speciale quadrato per terreni duri.
Acciaio zincato.

PEG BOX STICK PLUS 23

ART. 0303069N

€ TBC
10 / 10 / -
 23 cm x Ø 8 mm

PACK 20X

 26 x 8 x 17 cm
GLOWSpillone chiodo rotondo
con gancio in plastica, in
acciaio zincato.

PEG BOX STICK PLUS 25

ART. 0303070N

€ TBC
10 / 20 / -
 25 cm x Ø 8 mm

PACK 20X

 26 x 8 x 17 cm
GLOWSpillone chiodo rotondo
con gancio in plastica, in
acciaio zincato.

PEG BOX HEXA 22

ART. 0303072N

€ TBC
10 / 20 / -
 22 cm x Ø 8 mm

PACK 20X

 26 x 8 x 17 cm
Picchetto speciale per terreni duri.
Acciaio zincato.

PER TERRENI DURI





COBRA



PACK

M.O.

Master



ART. 0204001C	6 cm x Ø 4 mm	6X	€ TBC	20	80	-
ART. 0204001N	6 cm x Ø 4 mm		€ TBC	100	100	-

Gancio ad S in acciaio zincato.



ANCHOR



PACK

M.O.

Master



ART. 0301048C	30 mm	10X	€ TBC	20	40	-
ART. 0301048N	30 mm		€ TBC	100	100	-

Gancio ad ancora in alluminio.



SCREWBLOCK



PACK

M.O.

Master



ART. 0301059N	30 mm	4X	€ TBC	12	36	288
---------------	-------	----	-------	----	----	-----



Morsetto universale per funi e cavetti (non adatto per cavi elettrici).



RUNNER XL



PACK

M.O.

Master



ART. 0301061C	Ø 4 mm	10X	€ TBC	10	100	-
ART. 0301061N	Ø 4 mm		€ TBC	100	100	-

Grande tenditore in alluminio a 3 fori adatto per corde di tensione fino a 4 mm di diametro. Colore: rosso anodizzato. Indicato in particolare modo per tende di grandi dimensioni e/o gazebi.



RUNNER 2



PACK

M.O.

Master



ART. 0301063C	Ø 5 mm	10X	€ TBC	10	120	-
ART. 0301063N	Ø 5 mm		€ TBC	100	100	-

Tenditore per corda in alluminio a due fori.



RUNNER 3



PACK

M.O.

Master



ART. 0301064C	Ø 4 mm	10X	€ TBC	10	120	-
ART. 0301064N	Ø 4 mm		€ TBC	100	100	-
ART. 0301067C	Ø 5 mm	10X	€ TBC	10	120	-
ART. 0301067N	Ø 5 mm		€ TBC	100	100	-

Tenditore per corda in alluminio a tre fori.



CAPTURE

ART. 0102988N

€ TBC
1 / 12 / -



Ø 5,4 cm



120 g

Ventosa per tenda per minibus con corpo in metallo. Set 2 pz.

ATACO

ART. 0102985N

€ TBC
6 / 6 / 288



Ø 11,5 cm



2x 238 g

Set di ventose con anello a D per il fissaggio senza viti di tendalini parasole, tende per minibus, teloni e molto altro ancora su superfici lisce. Possono essere caricate fino a max 12 kg. Set 2 pz.

VANOOK

ART. 0102973N

€ TBC
12 / 24 / 336



Ø 12 cm



2x 250 g

Set di ventose ad uncino per il fissaggio semplice, veloce e senza viti di tendalini, verande minibus e parasole. Basta posizionare la ventosa nella posizione desiderata sulla carrozzeria del veicolo ed azionare la levetta di bloccaggio. Ogni ventosa sopporta un carico di 15 kg. Set 2 pz.



GORO

			M.O.	Master	
ART. 0301210N	Ø 3 mm x 20 m	€ TBC	12	12	-
ART. 0301212N	Ø 4 mm x 15 m	€ TBC	12	12	-

Cordino multiuso in poliestere intrecciato, su rocchetto.



POWER

			M.O.	Master	
ART. 0301220N.C00	Ø 3 mm x 20 m	€ TBC	6	24	-
ART. 0301221N.C00	Ø 3 mm x 50 m	€ TBC	6	24	-
ART. 0301202N.C00	Ø 4 mm x 20 m	€ TBC	6	24	-
ART. 0301223N.C00	Ø 4 mm x 50 m	€ TBC	6	24	-
ART. 0301222N.C00	Ø 5 mm x 20 m	€ TBC	6	24	-
ART. 0301224N.C00	Ø 5 mm x 50 m	€ TBC	6	24	-

Corda multiuso, in PP intrecciato.



SIGNAL

			M.O.	Master	
ART. 0301230N.C2M	Ø 3 mm x 20 m	€ TBC	6	24	-
ART. 0301231N.C2M	Ø 3 mm x 50 m	€ TBC	6	24	-

Corda multiuso con colorazione di sicurezza. In PP intrecciato.



STRIPER

		PACK		M.O.	Master	
ART. 0301256N.C00	Ø 4 mm x 4 m	4X	€ TBC	20	20	-

Corda tensione in PP con tenditore a tre fori.



C00



C2M

NOLAN

		PACK		M.O.	Master	
ART. 0301277N.C00	Ø 4 mm x 4 m	4X	€ TBC	6	30	-
ART. 0301277N.C2M	Ø 4 mm x 4 m	4X	€ TBC	6	30	-

Corda tensione in PP con tenditore a due fori ed anello.



STABILIZER KIT

ART. 0301311N

1,2 kg

€ TBC
10 / 10 / 400

Cinghia stabilizzante per verande camper e caravan in caso di vento. Il kit comprende: 1 nastro stabilizzatore (13 m) con molla di tensione e grandi picchetti di ancoraggio. Solo per uso temporaneo. L'utilizzo prolungato può provocare danni ai tessuti.



STABILIZER KIT UNIVERSAL

ART. 0301315N

1,2 kg

€ TBC
10 / 10 / 200

Kit cinghie stabilizzanti per verande caravan. Adatto per la maggior parte delle verande di produzione europea con fibbie premontate. Il set comprende 2 robusti picchetti di ancoraggio, 2 molle di scarico tensione e 2 cinghie di sicurezza.



EDOS

ART. 0301011C
PACK 6X

€ TBC
6 / 36 / -

ART. 0301011N
PACK -

€ TBC
100 / 100 / -

 Ø 5 mm x 7,3 cm

Elastico per soprateli di tende a cupola.



CIRCLE

ART. 0301022C
PACK 6X

€ TBC
10 / 40 / -

ART. 0301022N
PACK -

€ TBC
200 / 200 / -

 Ø int. 6 cm

Anello tensione rotondo PVC soft.



HOOKER

ART. 0301023C
PACK 6X

€ TBC
10 / 40 / 400

ART. 0301023N
PACK -

€ TBC
50 / 50 / 400

 Ø 5 mm x 16 cm

Controllore di tensione con gancio per tende e verande.



SIX-PACK

ART. 0301029C
PACK 6X

€ TBC
10 / 50 / -

ART. 0301029N
PACK -

€ TBC
100 / 100 / -

 21,5 x 2,5 cm

Elastico a scaletta a sei campi, senza linguetta.

FLEXO

Anello in gomma per tende. Elevata resistenza alla rottura.

FLEXO 8





FLEXO 12



FLEXO NT



			PACK	€ TBC	M.O.	Master	
FLEXO 8	ART. 0301019N	8 x 5 x 4 cm	10X	€ TBC	12	72	-
FLEXO 12	ART. 0301020N	12 x 4 x 5 cm	10X	€ TBC	12	72	-
FLEXO NT	ART. 0301021N	11 x 8 x 2 cm	10X	€ TBC	12	72	-



STRETCH

		PACK	€ TBC	M.O.	Master	
ART. 0902001C	Ø 0,8 x 50 cm	2X	€ TBC	10	40	-
ART. 0902001N	Ø 0,8 x 50 cm		€ TBC	20	20	-
ART. 0902003C	Ø 0,8 x 100 cm	2X	€ TBC	10	40	-
ART. 0902003N	Ø 0,8 x 100 cm		€ TBC	20	20	-
ART. 0902016C	Ø 0,8 x 150 cm	2X	€ TBC	10	20	-
ART. 0902016N	Ø 0,8 x 150 cm		€ TBC	10	10	-
ART. 0902017C	Ø 1 x 100 cm	2X	€ TBC	10	20	-
ART. 0902017N	Ø 1 x 100 cm		€ TBC	10	10	-
ART. 0902018C	Ø 1 x 150 cm	2X	€ TBC	10	20	-
ART. 0902018N	Ø 1 x 150 cm		€ TBC	10	10	-

Corda elastica fermabagagli con anima in gomma e ganci in acciaio su entrambi i lati.



POWER FIX

		PACK	€ TBC	M.O.	Master	
ART. 7710174C	50 x 2 cm	2X	€ TBC	12	24	-
ART. 7710177C	75 x 2 cm	2X	€ TBC	12	24	-
ART. 7710175C	100 x 2 cm	2X	€ TBC	12	24	-
ART. 7710178C	125 x 2 cm	2X	€ TBC	12	24	-
ART. 7710176C	150 x 2 cm	2X	€ TBC	12	24	-
ART. 7710179C	200 x 2 cm	2X	€ TBC	12	24	-
ART. 7710173C	250 x 2 cm	2X	€ TBC	12	24	-

Cinghiette di fissaggio con fibbia in metallo.



POWER-STRAP

		PACK	€ TBC	M.O.	Master	
ART. 7710180C	50 x 2 cm	2X	€ TBC	12	24	-
ART. 7710182C	75 x 2 cm	2X	€ TBC	12	24	-
ART. 7710184C	100 x 2 cm	2X	€ TBC	12	24	-

Cinghietta di fissaggio con fibbia di bloccaggio e regolazione in plastica.



PACK SOLID 2,5

ART. 7710183N

€ TBC
6 / 24 / -

- 2,5 m x 25 mm
- 100% Polyester

PACK SOLID 4

ART. 7710185N

€ TBC
6 / 24 / -

- 4,0 m x 25 mm
- 100% Polyester

Cinghia di fissaggio monopezzo con fibbia di bloccaggio in zinco pressofuso. Estremità della cinghia aperta per la reggiatura.
Forza di ancoraggio: 5 daN (250 kg).



PACK-MAN 2.0

ART. 7710187N

€ TBC
6 / 24 / -

- 5,0 m x 25 mm
- 100% Polyester

Cinghia di ancoraggio monopezzo con cricchetto robusto e antiscivolo in acciaio rivestito in gomma. Aree di applicazione: Kayak, barca, tenda, portapacchi, bicicletta, rimorchio, SUP, moto, tavola da surf, camper, caravan.
Forza di ancoraggio: 8 daN (400kg).





ARLO

ART. 0203012N

€ TBC
6 / 12 / -

95 x 21,5 x Ø 3/3,5 cm

45 x 23 x 6 cm

720 g

Pala multiuso composta da 3 elementi realizzati in lega di alluminio con impugnatura asimmetrica in plastica. Costruzione resistente per l'outdoor, il campeggio, il survival e la caccia, ecc. Con pratico fodero per il trasporto.



POLYCARBONATE



TRIFOLD

ART. 0203002N

€ TBC
6 / 24 / -

58 x 15,5 cm

23,5 x 15,5 cm

1,25 kg

Pala/zappa pieghevole in metallo forgiato. Lama seghettata e manico tubolare che viene serrato tramite un mandrino integrato. Completa di custodia.



SHOVEL



made in
EU

STRATOS

ART. 0202242C.C37

€ TBC
5 / 20 / -

25 m x 50 mm

PACK 1X

Nastro telato ad alta resistenza.



FORCE

ART. 0203040N

€ TBC
6 / 24 / 480

32 cm x Ø 55 mm

500 g

Martello da campeggio con manico in legno e mazzuolo in gomma.



HIT

ART. 0203048N

€ TBC
6 / 48 / 576

28,5 cm x Ø 52 mm

390 g

Martello da campeggio con manico anti-sdrucciolo. Mazzuolo in gomma piena.



BOMBER

ART. 0203008N

€ TBC
10 / 50 / -

31 x 11,3 x 4 cm

360 g

Martello per camping multifunzione realizzato interamente in metallo con solida testa a 2 battenti martello/piccozza, pratico gancio per l'estrazione dei picchetti e cinturino di sicurezza per la mano.



POLE KIT

		€ TBC	M.O.	Master	
ART. 0103032N	Ø 7,9 mm - 4x 65 cm	€ TBC	6	12	360
ART. 0103033N	Ø 8,5 mm - 4x 65 cm	€ TBC	6	12	324
ART. 0103034N	Ø 9,5 mm - 4x 75 cm	€ TBC	6	12	300
ART. 0103035N	Ø 11 mm - 4x 75 cm	€ TBC	6	12	288
ART. 0103039N	Ø 12,7 mm - 4x 75 cm	€ TBC	6	12	-

REPAIR KIT

		€ TBC	M.O.	Master	
ART. 0103037N	Ø 8,5/9,5 mm	€ TBC	5	25	-
ART. 0103040N	Ø 11/12,7 mm	€ TBC	5	25	150

Set pali di ricambio in fibra di vetro. Il set comprende: 4 pali in fibra di vetro con boccole premontate, un elastico di solidarizzazione e 2 puntali in metallo.

Set riparazione per tende composto da: pali di ricambio in fibra di vetro, elastico solidarizzatore, tessuto tenda e colla per tessuti.



POLECAP

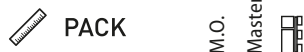

ART.	Dimensione	PACK	€ TBC	M.O.	Master	
ART. 0306015C	19 mm	4X	€ TBC	6	12	-
ART. 0306015N	19 mm		€ TBC	100	100	-
ART. 0306026C	22 mm	4X	€ TBC	6	12	-
ART. 0306026N	22 mm		€ TBC	100	100	-

Ventosa per palo tetto.



POLESPIKE



ART.	Dimensione	PACK	€ TBC	M.O.	Master	
ART. 0306018C	19 mm	3X	€ TBC	6	12	-
ART. 0306018N	19 mm		€ TBC	50	50	-
ART. 0306019C	22 mm	3X	€ TBC	6	12	-
ART. 0306019N	22 mm		€ TBC	50	50	-
ART. 0306020C	25 mm	3X	€ TBC	6	12	-
ART. 0306020N	25 mm		€ TBC	50	50	-

Puntale in materiale plastico.



POLEHOOK

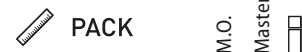

ART.	Dimensione	PACK	€ TBC	M.O.	Master	
ART. 0306046C	Ø 22 mm	5X	€ TBC	6	12	-
ART. 0306046N	Ø 22 mm		€ TBC	100	100	-
ART. 0306047C	Ø 25 mm	5X	€ TBC	6	12	-
ART. 0306047N	Ø 25 mm		€ TBC	100	100	-

Gancio per palo.



BLOCKER SHS



ART.	Dimensione	PACK	€ TBC	M.O.	Master	
ART. 0306008C	Ø 5 cm	3X	€ TBC	12	48	-
ART. 0306008N	Ø 5 cm		€ TBC	10	100	-

Sistema di fissaggio senza viti per pali tetto di verande.

STOPPER SHS



ART.	Dimensione	PACK	€ TBC	M.O.	Master	
ART. 0306009C	5 x 7 cm	3X	€ TBC	3	12	-
ART. 0306009N	5 x 7 cm		€ TBC	10	100	-

Stopper SHS per tutte le verande moderne con doppio profilo di scorrimento.



SMARTLOCK



ART.	Dimensione	PACK	€ TBC	M.O.	Master	
ART. 0305060C	22/19 mm	3X	€ TBC	6	24	-
ART. 0305061C	25/22 mm	3X	€ TBC	6	24	-
ART. 0305063C	28/25 mm	3X	€ TBC	6	24	-

Blocca-pali in plastica Smartlock. Disponibili per tutti i diametri di paleria più comuni.

ULTERIORI VANTAGGI DEGLI SMARTLOCK:

- Semplice da sostituire
- Sistema di bloccaggio senza viti e privo di parti metalliche
- Nessun danno o deformazione alla paleria
- Adatti a pali in acciaio e alluminio
- Di semplice utilizzo

MINIBASE

ART. 0306029N € TBC 10 / 40 / -

Ø 80 x H30 mm

PACK 2X

Base di appoggio per pali verticali, gradini d'entrata, ecc. Prodotto in materiale plastico robusto e stabile.

ROTOBASE

ART. 0306032N € TBC 10 / 40 / -

Ø 80 x 45 mm

PACK 2X

Base di appoggio con snodo rotante per pali verticali, gradini d'entrata, ecc. Prodotto in materiale plastico robusto e stabile.



POLESTING

ART.	Ø	Length	Price	M.O.	Master	Icon
ART. 0306048C	Ø 22 mm	5X	€ TBC	6	12	-
ART. 0306048N	Ø 22 mm		€ TBC	100	100	-
ART. 0306049C	Ø 25 mm	5X	€ TBC	6	12	-
ART. 0306049N	Ø 25 mm		€ TBC	100	100	-

Puntale per palo.



POLECLAMP

ART.	Ø	Length	Price	M.O.	Master	Icon
ART. 0306051C	Ø 22 - 25 mm	4X	€ TBC	6	12	-
ART. 0306051N	Ø 22 - 25 mm		€ TBC	100	100	-
ART. 0306052C	Ø 25 - 28 mm	4X	€ TBC	6	12	-
ART. 0306052N	Ø 25 - 28 mm		€ TBC	100	100	-

Morsetto per palo.

SUPPORTER



ART.	Ø	Length	Price	M.O.	Master	Icon
ART. 0306022C	Ø 22 mm	3X	€ TBC	6	12	-
ART. 0306022N	Ø 22 mm		€ TBC	100	100	-

Supporto paleria orizzontale in materiale plastico.

QEDER

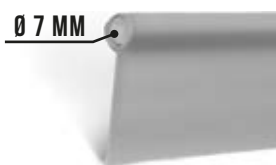

QEDER PVC

ART. 7401197N

€ TBC
1/2/-

Ø 7 mm, roll 50m x H25 mm

Profilo di scorrimento con flangia larga 25 mm.

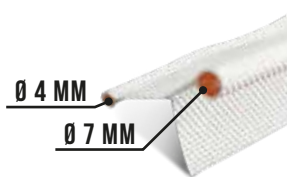

QEDER SHS

ART. 7401195N

€ TBC
50 / 100 / -

Ø 4/7 mm, roll 50m x H25 mm

Esecuzione come Art. 7401192N ma adatta al sistema di fissaggio senza viti (SHS). Profilo di scorrimento con flangia larga 25 mm.

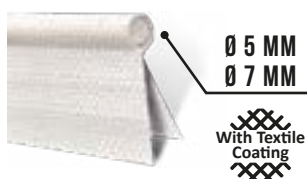

QEDER

ART. 7401196N	Ø 5 mm, roll 50m x H25 mm	€ TBC	50	100	-
ART. 7401192N	Ø 7 mm, roll 50m x H25 mm	€ TBC	50	100	-

Profilo di scorrimento con flangia larga 25 mm.

ART. 7401020N

QEDER ADAPTER SET



ART. 7401020N	Ø 7 mm x 3 m	€ TBC	1	10	100
ART. 7401018N	Ø 5/7 mm x 4 m	€ TBC	1	10	150

Kit per collegare la tenda minibus al veicolo.

TELEPOLE

Palo verticale telescopico in alluminio anodizzato a tre elementi Ø 31/26/21 mm. Con puntale e base.

TELEPOLE 80-190

ART. 0305034N

€ TBC
6 / 24 / 744

80 - 190 cm

TELEPOLE 100-230

ART. 0305035N

€ TBC
6 / 24 / 432

100 - 230 cm

SET TELEPOLE

ART. 0305036N

€ TBC
2 / 6 / -

100 - 230 cm

PACK 2X



DOUBLE 8

ART.	Length	Price	M.O.	Master	Icon
ART. 7401021N	100 cm	€ TBC	12	12	-
ART. 7401022N	250 cm	€ TBC	6	6	-

Profilo di congiunzione in materiale plastico. Ottimo per collegare tendalini a verande.



ALU RAIL

ART. 7401023N

€ TBC
1 / 1 / -

3 m

Profilo in alluminio anodizzato.



SMARTPOLES



Acciaio

Acciaio: viene utilizzato nelle verande permanenti o invernali a causa della particolare rigidità. Tutti i pali Brunner in acciaio sono stati sottoposti ad un doppio processo di protezione (zincatura e laccatura).



Alluminio: materiale ideale per tende leggere da viaggio e tendalini. Caratteristiche: peso ridotto, praticamente non corrodibile. Tutti i pali Brunner in alluminio dispongono di una superficie anodizzata.



1 SMARTPOLE RIDGE



Acciaio



PACK

M.O.



ART. 0305021C	Ø 22x1/115-200 cm	1X	€ TBC	5	10	-
ART. 0305048C	Ø 22x1/170-260 cm	1X	€ TBC	5	10	-
ART. 0305025C	Ø 25x1/170-260 cm	1X	€ TBC	5	10	-



PACK

M.O.



ART. 0305050C	Ø 25x1/170-260 cm	1X	€ TBC	5	10	-
---------------	-------------------	----	-------	---	----	---

2 SMARTPOLE ROOF SUPPORT



Acciaio



PACK

M.O.



ART. 0305006C	Ø 22x1/75-120 cm	1X	€ TBC	5	10	-
ART. 0305041C	Ø 22x1/115-200 cm	1X	€ TBC	5	10	-
ART. 0305049C	Ø 25x1/115-200 cm	1X	€ TBC	5	10	-
ART. 0305046C	Ø 22x1/170-260 cm	1X	€ TBC	5	10	-
ART. 0305057C	Ø 25x1/170-260 cm	1X	€ TBC	5	10	-



PACK

M.O.



ART. 0305070C	Ø 25x1/115-205 cm	1X	€ TBC	5	10	-
ART. 0305071C	Ø 25x1/170-260 cm	1X	€ TBC	5	10	-



Pali aggiuntivi per dare alla veranda ulteriore stabilità in caso di vento forte, pioggia o neve. I nostri pali sono disponibili in 2 versioni.

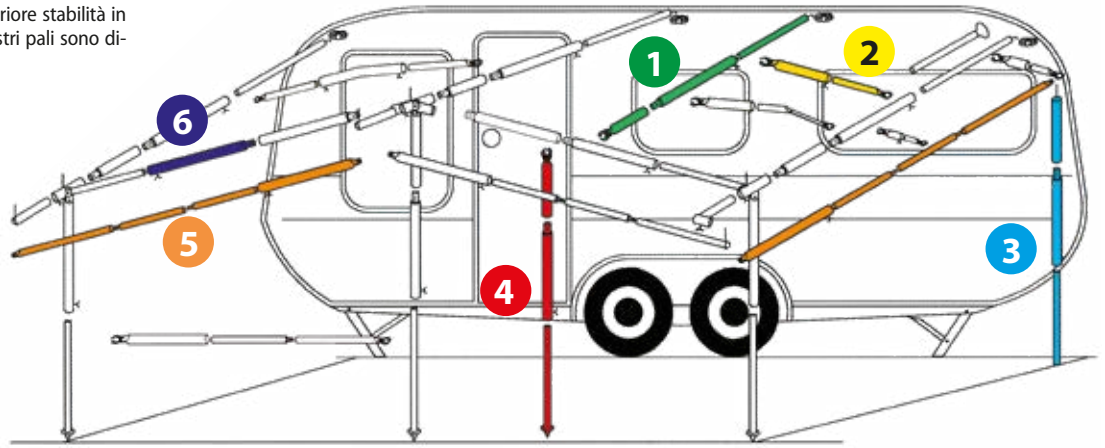

3 SMARTPOLE UP-RIGHT



ART.	Ø	Length	PACK	€	M.O.	Master
ART. 0305022C	22x1	110-200 cm	1X	€ TBC	5	10 -
ART. 0305028C	22x1	165-250 cm	1X	€ TBC	5	10 -



ART.	Ø	Length	PACK	€	M.O.	Master
ART. 0305037C	25x1	110-200 cm	1X	€ TBC	5	10 -
ART. 0305038C	25x1	165-250 cm	1X	€ TBC	5	10 -

5 SMARTPOLE TENSION FLAT ENDS



ART.	Ø	Length	PACK	€	M.O.	Master
ART. 0305024C	22x1	110-200 cm	1X	€ TBC	5	5 200
ART. 0305023C	22x1	200-280 cm	1X	€ TBC	5	10 200



ART.	Ø	Length	PACK	€	M.O.	Master
ART. 0305032C	25x1	110-200 cm	1X	€ TBC	5	10 129
ART. 0305033C	25x1	200-280 cm	1X	€ TBC	5	10 -

4 SMARTPOLE STORM



ART.	Ø	Length	PACK	€	M.O.	Master
ART. 0305103C	22x1	115-200 cm	1X	€ TBC	5	10 -
ART. 0305047C	22x1	170-260 cm	1X	€ TBC	5	10 -
ART. 0305098C	25x1	170-260 cm	1X	€ TBC	5	10 -



ART.	Ø	Length	PACK	€	M.O.	Master
ART. 0305145C	25x1	115-200 cm	1X	€ TBC	5	10 -
ART. 0305146C	25x1	170-260 cm	1X	€ TBC	5	10 -

6 SMARTPOLE EXTENSION



ART.	Ø	Length	PACK	€	M.O.	Master
ART. 0305003C	19x1	80 cm	1X	€ TBC	5	10 -
ART. 0305001C	22x1	80 cm	1X	€ TBC	5	10 -
ART. 0305002C	25x1	80 cm	1X	€ TBC	5	10 -



ART.	Ø	Length	PACK	€	M.O.	Master
ART. 0305044C	25x1	80 cm	1X	€ TBC	5	10 -



EYELET

ART. 0202045N

€ TBC

Ø int. 10 mm

12 / 72 / -

PACK 20X

Occhielli in ottone completi di kit di montaggio.



SNAP

ART. 0202054N

€ TBC

Ø int. 10 mm

12 / 144 / -

PACK 8X

Bottoni a pressione in metallo nichelato completi di kit per l'applicazione.

MULTICOVER 170

COLORS

C74



M.O. Master

ART.	Size (cm)	€ TBC	M.O.	Master	Icon
ART. 7130270N.C74	200 x 200 cm	€ TBC	25	25	400
ART. 7130271N.C74	200 x 300 cm	€ TBC	20	20	360
ART. 7130277N.C74	300 x 300 cm	€ TBC	10	10	200
ART. 7130272N.C74	300 x 400 cm	€ TBC	10	10	160
ART. 7130285N.C74	300 x 500 cm	€ TBC	6	6	120
ART. 7130286N.C74	300 x 600 cm	€ TBC	4	4	80
ART. 7130287N.C74	300 x 700 cm	€ TBC	5	5	90
ART. 7130278N.C74	400 x 400 cm	€ TBC	10	10	120
ART. 7130273N.C74	400 x 500 cm	€ TBC	6	6	96
ART. 7130279N.C74	400 x 600 cm	€ TBC	5	5	80
ART. 7130288N.C74	400 x 700 cm	€ TBC	5	5	30
ART. 7130280N.C74	500 x 500 cm	€ TBC	5	5	90
ART. 7130274N.C74	500 x 600 cm	€ TBC	4	4	48
ART. 7130275N.C74	500 x 700 cm	€ TBC	3	3	-
ART. 7130281N.C74	600 x 700 cm	€ TBC	3	3	48
ART. 7130276N.C74	600 x 800 cm	€ TBC	2	2	42
ART. 7130282N.C74	600 x 1000 cm	€ TBC	2	2	36
ART. 7130283N.C74	800 x 1000 cm	€ TBC	2	2	24



Teloni di copertura in PE laminato su entrambi i lati.



MULTICOVER



MULTICOVER 100

COLORS **C06**



ART.	Size	€ TBC	M.O.	Master	Icon
ART. 7130290N.C06	200 x 200 cm	€ TBC	25	25	720
ART. 7130291N.C06	200 x 300 cm	€ TBC	20	20	540
ART. 7130292N.C06	300 x 300 cm	€ TBC	10	10	315
ART. 7130293N.C06	300 x 400 cm	€ TBC	10	10	189
ART. 7130294N.C06	400 x 400 cm	€ TBC	10	10	168
ART. 7130295N.C06	400 x 500 cm	€ TBC	6	6	144
ART. 7130296N.C06	400 x 600 cm	€ TBC	5	5	105

Teloni di copertura in polietilene, spalmati su entrambi i lati. Dotati di occhielli su tutti gli angoli e lungo i bordi rinforzati per un fissaggio semplice. Ideale per coprire e proteggere dalle intemperie mobili da giardino e camping, rimorchi, biciclette, catini di tende e verande ed equipaggiamento vario tra cui anche materiale edile.



TARPCLIP

ART. 0301051N

€ TBC
6 / 84 / -

4 x 8 cm

PACK 4X

Morsetto rapido per stuoie veranda, tappeti e teloni. Prodotto in nylon rinforzato con fibra di vetro di lunga durata.



TARPEYE

ART. 0301054N

€ TBC
50 / 200 / -

5 x 10 cm

PACK 4X

Occhio in plastica per teloni.



BUNGEE BALL

ART. 0301057C

€ TBC
5 / 20 / -

PACK 6X

ART. 0301057N

€ TBC
50 / 500 / -

PACK -

Ø int. 10 mm

PACK 6X

Sfera bloccateloni con elastico per occhielli di diametro massimo 25 mm.



CLAMP

ART. 0301060C

€ TBC
12 / 72 / -

PACK 4X

ART. 0301060N

€ TBC
100 / 500 / -

PACK -

25 mm x Ø 4 mm

PACK 4X

Aggancio per stuoie e teloni. In plastica flessibile.



FLOOR & DOOR

**STUOIE E PEDANE
TENDE PER PORTE**



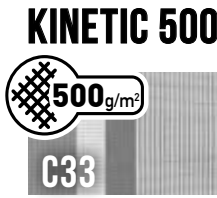
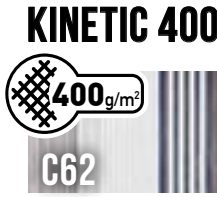
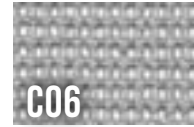
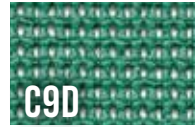
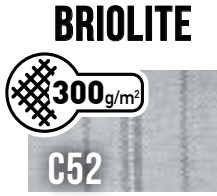
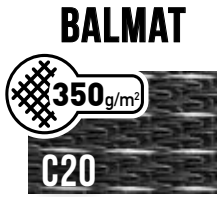

COLOURS AND DESIGNS

CARPET OVERVIEW

	PARAGON	PURAMAT	BALMAT	TRIP	BRIOLITE	YUROP	KINETIC	KINETIC	KINETIC
TESSUTO	PE	PES	PP	PP	PP	PVC/PES	PVC/PET	PVC/PET	PVC/PET
PESO TESSUTO	250 g/m ²	350 g/m ²	350 g/m ²	200 g/m ²	300 g/m ²	450 g/m ²	400 g/m ²	500 g/m ²	600 g/m ²
SENZA FTALATI	•	-	•	•	•	•	•	•	•
TAGLIABILE A FREDDO	-	-	-	-	-	•	•	•	•
TRASPIRANTE	•	•	•	•	•	•	-	-	-
IN ROTOLI	-	-	-	•	-	•	•	•	•
IN TAGLI	•	•	•	•	•	•	•	•	•



PARAGON



PARAGON



BAG



			M.O.	Master	
ART. 0201284N	250 x 300 cm	€ TBC	2	2	48
ART. 0201286N	250 x 400 cm	€ TBC	2	2	48
ART. 0201288N	250 x 500 cm	€ TBC	2	2	40
ART. 0201290N	250 x 600 cm	€ TBC	2	2	36

La stuoia Paragon è la soluzione ideale per le verande ed i tendalini di roulotte e camper, absidi tende, cucinotti e gazebo. Completa di lati bordati ed occhielli.

CARATTERISTICHE:

- Traspirante
- Realizzata in tessuto eco-compatibile
- Protegge efficacemente contro gli insetti fastidiosi
- Facile da pulire
- Materiale durevole
- Dotata di pratici occhielli
- Resistente ai raggi UV
- Imputrescibile
- Resistente alle intemperie
- Con borsa per il trasporto

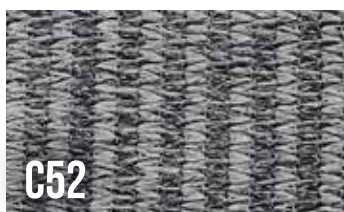

INCLUDING
TRANSPORT BAG



PHTHALATE free





PURAMAT



PURAMAT



BAG

		€ TBC	M.O.	Master	
ART. 0201251N	250 x 300 cm	€ TBC	2	2	40
ART. 0201252N	250 x 350 cm	€ TBC	2	2	40
ART. 0201253N	250 x 400 cm	€ TBC	2	2	30
ART. 0201254N	250 x 450 cm	€ TBC	2	2	30
ART. 0201255N	250 x 500 cm	€ TBC	2	2	30

Stuoia per tende e tendalini, antipolvere ed anti-sabbia e realizzata con un nuovo materiale in poliestere appositamente lavorato.

CARATTERISTICHE:

- Permeabile all'aria
- Idrorepellente
- Leggera
- Facile da piegare
- Non si sfilaccia
- Durevole
- Con anelli di fissaggio agli angoli
- Incl. borsa custodia



Con anelli di fissaggio agli angoli



INCLUDING
TRANSPORT BAG





BALMAT

PHTHALATE free

100%
PP

Pb
Lead Free

Stuoia per verande leggerissima. Utilizzabile su entrambi i lati. Particolarmente indicata per caravan e camper di dimensioni piccole/medie.

BALMAT



BAG



M.O.

Master



ART. 0102044N	250 x 300 cm	€ TBC	2	2	20
ART. 0102045N	250 x 350 cm	€ TBC	2	2	20
ART. 0102046N	250 x 400 cm	€ TBC	2	2	20
ART. 0102047N	250 x 450 cm	€ TBC	2	2	20
ART. 0102064N	250 x 500 cm	€ TBC	2	2	20
ART. 0102065N	250 x 600 cm	€ TBC	2	2	20
ART. 0102066N	250 x 700 cm	€ TBC	2	2	12

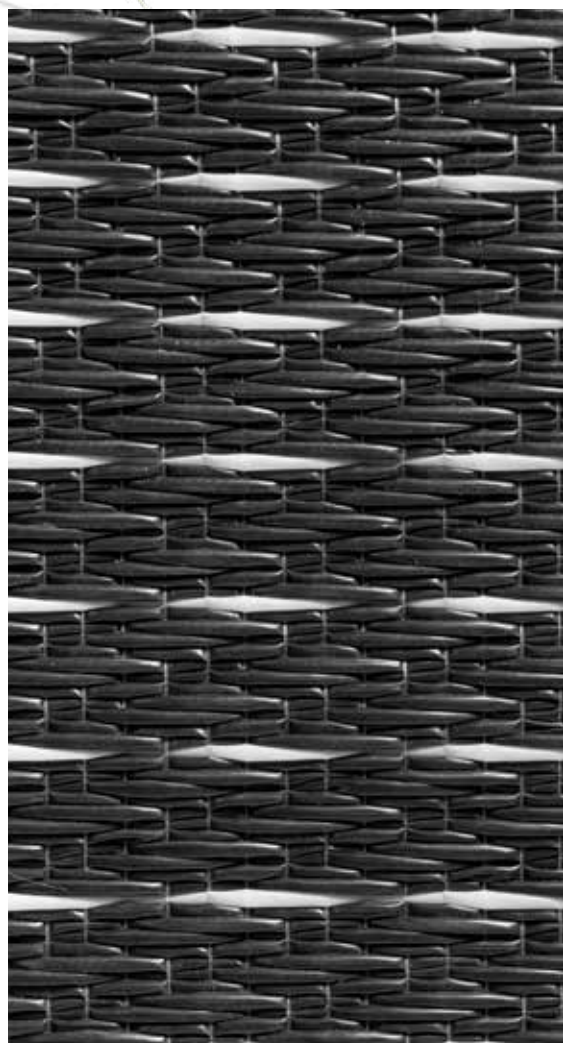
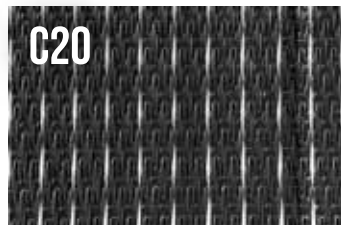



BALMAT

PHTHALATE free



Stuoia per verande leggerissima. Utilizzabile su entrambi i lati. Particolarmente indicata per caravan e camper di dimensioni piccole/medie.

BALMAT



BAG

			M.O.	Master	
ART. 0102044N	250 x 300 cm	€ TBC	2	2	20
ART. 0102045N	250 x 350 cm	€ TBC	2	2	20
ART. 0102046N	250 x 400 cm	€ TBC	2	2	20
ART. 0102047N	250 x 450 cm	€ TBC	2	2	20
ART. 0102064N	250 x 500 cm	€ TBC	2	2	20
ART. 0102065N	250 x 600 cm	€ TBC	2	2	20
ART. 0102066N	250 x 700 cm	€ TBC	2	2	12
ART. 0102067N	300 x 300 cm	€ TBC	2	2	16
ART. 0102068N	300 x 350 cm	€ TBC	2	2	16
ART. 0102069N	300 x 400 cm	€ TBC	2	2	16
ART. 0102070N	300 x 450 cm	€ TBC	2	2	16
ART. 0102071N	300 x 500 cm	€ TBC	2	2	16
ART. 0102072N	300 x 600 cm	€ TBC	2	2	16
ART. 0102073N	300 x 700 cm	€ TBC	2	2	12

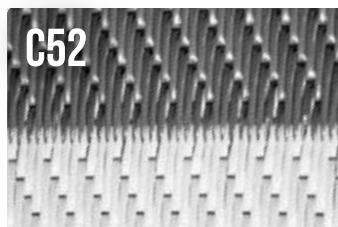

INFO



Stuoia leggera e salvaspazio in fibra di polipropilene a lunga durata. Ideale per il campeggio itinerante, ma anche per le verande delle caravan. La struttura in tessuto traspirante e indeformabile permette al terreno di respirare e crea un piacevole ambiente di soggiorno. Disponibile in varie dimensioni, colori e spessori di materiale.

IN EVIDENZA:

- Facile da pulire
- Lavabile
- Imputrescibile
- Traspirante
- Antistrappo
- Resistente ai raggi UV
- Riciclabile
- Con borsa di trasporto riutilizzabile

YUROP



ART.	Dimensione (€/m)	€ TBC	M.O.	Master	Unità
ART. 0201074N	H2,5 x 30 m	€ TBC	1	1	30
ART. 0201075N	H3 x 30 m	€ TBC	1	1	30



ART.	Dimensione	€ TBC	M.O.	Master	Unità
ART. 0201077N	250 x 300 cm	€ TBC	2	2	32
ART. 0201081N	250 x 350 cm	€ TBC	2	2	32
ART. 0201082N	250 x 400 cm	€ TBC	2	2	36
ART. 0201083N	250 x 450 cm	€ TBC	2	2	32
ART. 0201088N	250 x 500 cm	€ TBC	2	2	32
ART. 0201089N	250 x 600 cm	€ TBC	2	2	32
ART. 0201078N	300 x 300 cm	€ TBC	2	2	24
ART. 0201079N	300 x 400 cm	€ TBC	2	2	32
ART. 0201080N	300 x 500 cm	€ TBC	2	2	32
ART. 0201084N	300 x 600 cm	€ TBC	1	1	16
ART. 0201085N	300 x 700 cm	€ TBC	1	1	14

PHthalate free



YUROP

La stuoia Yurop è un classico quando si è in tema di accessori per il campeggio. La sua robustezza, la sua elasticità ed il suo comfort al tatto la rendono una soluzione estremamente pratica da usare per rendere il pavimento delle tende o delle tende da sole elegante e accogliente. Disponibile in diverse taglie.

CARATTERISTICHE:

- Facile da pulire
- Tagliabile
- Imputrescibile
- Piacevole comfort al tatto
- Traspirante
- Antistrappo
- Resistente ai raggi UV
- Antiscivolo
- Con borsa di trasporto riutilizzabile

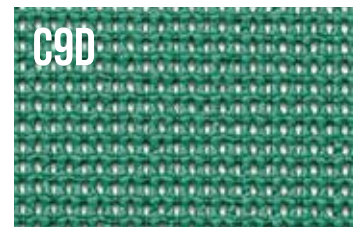
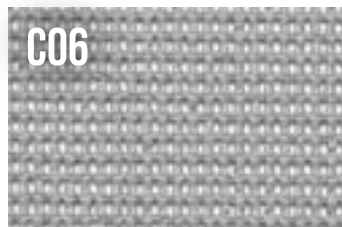

SOLO IN ROTOLI

CARPEG

ART. 0303013C
PACK 6X

€ TBC
6 / 30 / -



20 cm x Ø 6 mm

ART. 0303013N
PACK -

€ TBC
100 / 100 / -

PEGGY

ART. 0303019C
PACK 6X

€ TBC
10 / 50 / -



20 cm x Ø 8 mm

ART. 0303019N
PACK -

€ TBC
100 / 100 / -

PICKET

ART. 0303018C
PACK 6X

€ TBC
10 / 50 / -



20 cm x Ø 8 mm

Spillone chiodo fermastuoia in acciaio con ranella Ø 38 mm in materiale plastico.

Speciale picchetto in metallo per fissare stuoie e teloni.

Picchetto fermastuoia in materiale plastico.

TRIP

ROLL



PHTHALATE free

100% PP

made in EU

ART.	Dimensioni	Prezzo	M.O.	Master	Icona
ART. 0201241N	H2,5 x 50 m (€/m)	€ TBC	50	50	-

BAG



ART.	Dimensioni	Prezzo	M.O.	Master	Icona
ART. 0201242N	250 x 300 cm	€ TBC	1	10	80
ART. 0201243N	250 x 350 cm	€ TBC	1	9	72
ART. 0201244N	250 x 400 cm	€ TBC	1	8	64
ART. 0201245N	250 x 450 cm	€ TBC	1	8	64
ART. 0201246N	250 x 500 cm	€ TBC	1	7	56
ART. 0201247N	250 x 600 cm	€ TBC	1	6	48
ART. 0201248N	250 x 700 cm	€ TBC	1	5	20

Resistente stuoia per tende e verande.

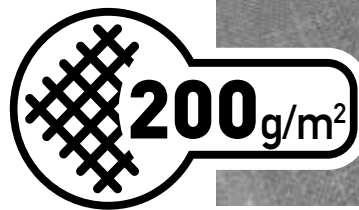

TRIP

BRIOLITE

BAG



PHTHALATE free

100% PP

made in EU

ART.	Dimensioni	Prezzo	M.O.	Master	Icona
ART. 0201091N	250 x 300 cm	€ TBC	1	10	80
ART. 0201092N	250 x 350 cm	€ TBC	1	9	72
ART. 0201093N	250 x 400 cm	€ TBC	1	8	72
ART. 0201094N	250 x 450 cm	€ TBC	1	8	64
ART. 0201095N	250 x 500 cm	€ TBC	1	7	56

Stuoia per tende e verande in tessuto PP.

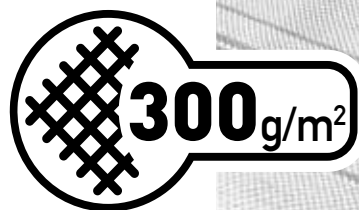
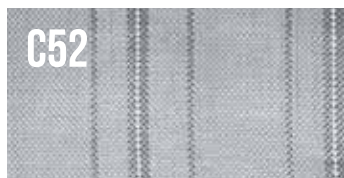

BRIOLITE



Stuoia per verande di ottima qualità perfettamente indicata sia per campeggio stanziale che quello itinerante ed abbinabile a verande caravan, verande avvolgibili, tendalini parasole e tende per minivan. Realizzata in ottima fibra sintetica resistente ai raggi UV. Utilizzabile su entrambi i lati. Idrorepellente, imputrescibile e facile da pulire. Accorciabile a freddo senza pericolo che si sfrangi. Senza ftalati. Disponibile in ben 12 misure pretagliate ed in 3 grammature di tessuto, selezionabili a seconda dell'utilizzo previsto.

PHTHALATE free



30% PET
70% PVC

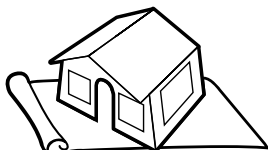
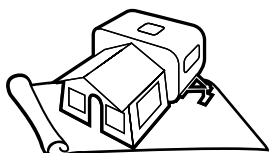
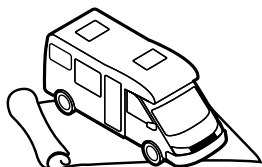

Stuoia per verande di ottima qualità perfettamente indicata sia per il campeggio stanziale che per quello itinerante. Disponibile in 3 grammature di tessuto, selezionabili a seconda dell'utilizzo previsto.

CARATTERISTICHE:

- Tessitura speciale ad alta resistenza
- Utilizzabile su entrambi i lati
- Accorciabile a freddo
- Imputrescibile
- Idrorepellente
- Lavabile
- Senza ftalati



KINETIC

KINETIC 400



ART.	Misure (€/m)	€ TBC	M.O.	Master	Icona
ART. 0201136N	H2,5 x 30 m (€/m)	€ TBC	1	1	-



ART.	Misure	€ TBC	M.O.	Master	Icona
ART. 0201137N	250 x 300 cm	€ TBC	2	2	56
ART. 0201138N	250 x 350 cm	€ TBC	2	2	56
ART. 0201139N	250 x 400 cm	€ TBC	2	2	56
ART. 0201146N	250 x 450 cm	€ TBC	2	2	56
ART. 0201147N	250 x 500 cm	€ TBC	2	2	56
ART. 0201148N	250 x 600 cm	€ TBC	2	2	56
ART. 0201149N	250 x 700 cm	€ TBC	2	2	56





KINETIC 500

KINETIC 600



ART.	Dimensione (cm)	Prezzo (€/m)	M.O.	Master	Icona
ART. 0201260N	H2,5 x 30 m (€/m)	€ TBC	1	1	-
ART. 0201261N	H3 x 30 m (€/m)	€ TBC	1	1	-

ART.	Dimensione (cm)	Prezzo (€/m)	M.O.	Master	Icona
ART. 0201105N	H2,5 x 30 m (€/m)	€ TBC	30	30	-
ART. 0201118N	H3 x 30 m (€/m)	€ TBC	30	30	-



ART.	Dimensione (cm)	Prezzo (€/m)	M.O.	Master	Icona
ART. 0201262N	250 x 300 cm	€ TBC	2	2	48
ART. 0201263N	250 x 350 cm	€ TBC	2	2	48
ART. 0201264N	250 x 400 cm	€ TBC	2	2	40
ART. 0201265N	250 x 450 cm	€ TBC	2	2	40
ART. 0201266N	250 x 500 cm	€ TBC	2	2	40
ART. 0201267N	250 x 600 cm	€ TBC	2	2	32
ART. 0201268N	250 x 700 cm	€ TBC	2	2	32
ART. 0201269N	300 x 300 cm	€ TBC	2	2	48
ART. 0201270N	300 x 400 cm	€ TBC	2	2	48
ART. 0201271N	300 x 500 cm	€ TBC	2	2	48
ART. 0201272N	300 x 600 cm	€ TBC	2	2	32
ART. 0201273N	300 x 700 cm	€ TBC	2	2	26

ART.	Dimensione (cm)	Prezzo (€/m)	M.O.	Master	Icona
ART. 0201106N	250 x 300 cm	€ TBC	2	2	56
ART. 0201107N	250 x 350 cm	€ TBC	2	2	56
ART. 0201108N	250 x 400 cm	€ TBC	2	2	56
ART. 0201109N	250 x 450 cm	€ TBC	2	2	48
ART. 0201110N	250 x 500 cm	€ TBC	2	2	48
ART. 0201111N	250 x 600 cm	€ TBC	2	2	40
ART. 0201112N	250 x 700 cm	€ TBC	2	2	32
ART. 0201131N	300 x 300 cm	€ TBC	2	2	48
ART. 0201132N	300 x 400 cm	€ TBC	2	2	48
ART. 0201133N	300 x 500 cm	€ TBC	2	2	40
ART. 0201134N	300 x 600 cm	€ TBC	2	2	32
ART. 0201135N	300 x 700 cm	€ TBC	2	2	32

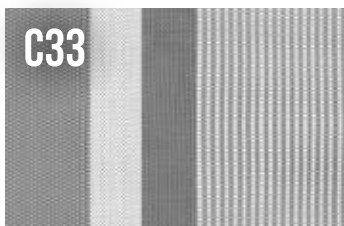





DECK-FIT

ART. 0201032N

€ TBC
120 / 120 / 120

 38,5 x 38,5 x H5 cm

 1,2 kg

 PP / PE

 4,5 t/m²

 COLORS  

Mattonelle Deck-Fit in materiale plastico per la realizzazione di pavimentazioni esterne di vario tipo.



DECK

OPTIONAL

DECK RAMP

ART. 0201033N

€ TBC
4 / 40 / -

 38,5 x 15 x H5 cm

 220 g

 100% PP

 COLORS  

Rampa laterale per mattonelle Deck-Fit. Con elementi di collegamento.



DECK CORNER

ART. 0201036N

€ TBC
2 / 2 / -

 20,5 x 15 x H5 cm

 60 g

 100% PP

 COLORS  

Angolare per mattonelle Deck-Fit.

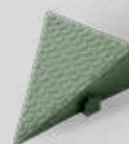



ZERBY

ART. 7225150N

€ TBC
6 / 12 / 144

 34 x 27,5 x 6 cm

 980 g

Zerbino con struttura in legno.



HELLO CAMPER

ART. 0201034N.CA

€ TBC
5 / 15 / 540

 25 x 50 cm

 100% PP



Pratico zerbino con simpatici motivi legati al camper e alla caravan. Protegge gli interni del mezzo da terra, polvere e sporco. Dotato di rivestimento inferiore antiscivolo.

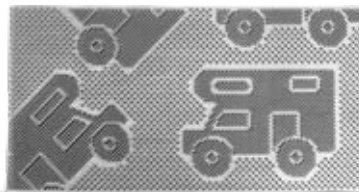

TRIMMAT S

ART. 0201037N

€ TBC
5 / 15 / 540

 25 x 50 cm

 RUBBER



HELLO CARAVAN

ART. 0201034N.CV

€ TBC
5 / 15 / 540

 25 x 50 cm

 100% PP

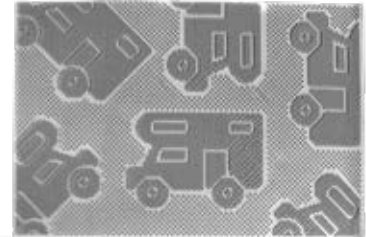

TRIMMAT L

ART. 0201038N

€ TBC
5 / 10 / 500

 40 x 60 cm

 RUBBER

Pratico zerbino realizzato in gomma molto resistente. Ideale per l'uso esterno. Colore grigio.

HELLO





Tendina in plastica con filamenti intrecciati.

MEANDER

ART. 7232149N

€ TBC
12 / 48 / 96

 60 x 190 cm

 100% PVC





Tenda antizanzare dai molteplici impieghi.

ZANZIBAR S

ART. 7232150N

€ TBC
8 / 8 / 384

 56 x 185 cm

 100% PP

ZANZIBAR L

ART. 7232152N

€ TBC
8 / 8 / 192

 100 x 200 cm

 100% PP





Tenda per porte realizzata in materiale plastico PVC 100% riciclabile.

RIBBON

ART. 7232154N

€ TBC
6 / 48 / 96

 60 x 190 cm

 100% PVC



ACAPULCO

ACAPULCO



		€ TBC	M.O.	Master	
ART. 7233100N	56 x 185 cm	€ TBC	6	18	54
ART. 7233105N	56 x 205 cm	€ TBC	6	18	54
ART. 7233101N	70 x 205 cm	€ TBC	6	18	24
ART. 7233102N	100 x 205 cm	€ TBC	4	12	24

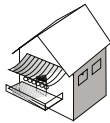
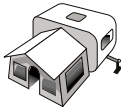
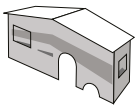

Tendina in ciniglia di ottima qualità per tempo il libero, la casa e il giardino.

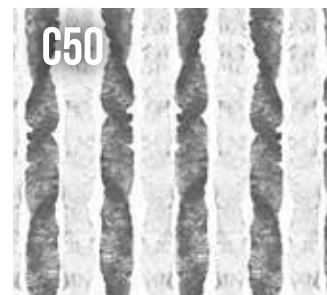

OUTDOOR EMOTIONS



LAMPS & LANTERNS

**LANTERNE CAMPING
LAMPADE PER TENDE
LAMPADE FRONTALI**



FARO

INFO P. 117



COOL
WARM WHITE
LIGHT

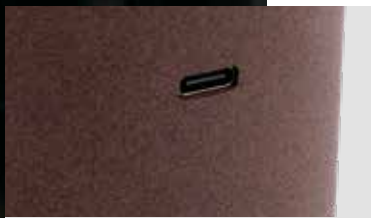

USB OUTPUT
USB C INPUT - 5V/3A



ON / OFF



Anti Slip
Base

INFO







LED - (Light Emitting Diode) fanno parte del gruppo dei semiconduttori ed hanno un consumo ridottissimo di energia (solo il 5-10% di una normale lampadina ad incandescenza), sono molto resistenti ed eccellono per la loro lunghissima durata (in media oltre 10 anni). Il cono luce prodotto dai LED si è dimostrato molto vantaggioso per la maggior parte delle applicazioni possibili. Inoltre risulta essere più piacevole per l'occhio umano rispetto al raggio concentrato puntiforme delle tradizionali torce elettriche che sono comunque ottime per illuminare a lunga distanza.



LAMPARINA

ART. 0720068N

€ TBC
12 / 24 / -

-  3,7V Li-ion - 4000mAh
-  120 lumen
-  15h
-  Tungsten Led bulb
-  Ø 10,3 x H16,4 cm
-  375 g
-  6W









Lanterna ricaricabile per Outdoor e Camping dal look professionale. Dona una luce piacevole grazie all'illuminazione a LED di colore bianco caldo. Dotata di 2 livelli di intensità luce e di uno schermo in materiale plastica traslucente. Con pratica maniglia in acciaio per il trasporto o per appenderla. La batteria integrata agli ioni di litio può essere ricaricata con il cavo USB in dotazione.



LYSS

ART. 0720066N

€ TBC
6 / 12 / -

-  3,7V Li-ion - 5200mAh
-  15-450 lumen
-  6-200 h
-  30
-  Ø 12,6 x H30,5cm (included handle)
-  560 g
-  8W



Elegante lanterna LED con resistente struttura realizzata in metallo verniciato, base in bambù e schermo traslucente in materiale plastico. Dotata di interruttore dimmer ON-OFF con 2 modalità di illuminazione: una a luce calda ed una a luce bianca. La batteria integrata agli ioni di litio può essere ricaricata con il cavo USB in dotazione. Utilizzabile in molteplici applicazioni.



COOL  **WHITE**
LIGHT



QUADRILUX

ART. 0720047N

€ TBC
2 / 6 / 150

- 3600mA
- 200 lumen
- 7-48h
- 48
- 10 x 30 cm
- 900 g
- 3W



LUCIEN

ART. 0720048N

€ TBC
5 / 10 / 160

- 3600mA
- 200 lumen
- 16-24h
- 48
- 11 x 25 cm
- 900 g
- 3W



COLORS



FARO

ART. 0720049N.C02

€ TBC
5 / 10 / -

- 3600mA
- 200 lumen
- 16
- 48
- 8 x 25 cm
- 400 g
- 3W

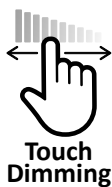

Lantern da tavolo ricaricabile per esterni dal design moderno e dall'aspetto professionale. Fornisce una luce piacevole grazie all'illuminazione LED in bianco caldo. Dotata di regolazione di intensità luminosa e di un elegante paralume in metallo. La batteria integrata agli ioni di litio può essere ricaricata in qualsiasi momento tramite il cavo USB in dotazione.









**LED
HIGHPOWER
200 lumen**

NEXUS LED

ART. 0720065N

€ TBC
10 / 100 / -

-  USB plug 5V
-  200 lumen
-  6
-  Ø 5 cm / 2m power line / 20cm connection line
-  100 g
-  5W



Lampada Outdoor a LED con cavi USB integrati che consentono di collegare tra loro, in serie, fino a 4 luci. Luminosa e leggera, la lampada a catena fornisce 200 Lumen per l'illuminazione di tende, tende da sole e gazebo. Il paralume regolabile è realizzato in morbido silicone e permette di scegliere tra luce soffusa o spot. Basso consumo energetico per una luce di lunga durata ottenibile da qualsiasi porta USB. Include un moschettone per appendere.

CARATTERISTICHE:

- Corpo lampada: termoplastica con diffusore in silicone
- Diametro lampada: 30 mm
- Collegamento elettrico: tramite spina USB
- Collegamento in serie: tramite connettore USB femmina









COLLAPSIBLE

MIZAR

ART. 0720062N

€ TBC
12 / 24 / -

-  3xAA (1,5V) not incl.
-  90 lumen
-  16h
-  1
-  4,7 x 4,7 x H9/15 cm
-  100 g









Lanterna LED, molto compatta quando richiusa. Corpo lanterna in ABS. Leggera e semplice da riporre. Completa di interruttore ON/OFF con modalità Flash, gancio per appenderla e magneti di fissaggio. Funzionamento a batteria.

STARWAY

ART. 0720031N

€ TBC
6 / 12 / -

-  1800mAh Polymer Lithium
-  200 lumen
-  3,5h - 10h
-  100+30
-  Ø 9 x 6 cm + light strip 8 m
-  210 g



La lampada da campeggio ricaricabile Brunner Starway è l'accessorio perfetto per la tua prossima avventura all'aria aperta. Con le sue innovative strisce luminose flessibili e arrotolabili, puoi facilmente decorare la tenda o il tendone, creando un'atmosfera accogliente e incantevole. Grazie alla sua protezione IP44, le strisce luminose sono resistenti all'acqua, perfette anche per le condizioni meteorologiche più avverse. Con una batteria da 1800mAh, puoi goderti la luce per lungo tempo senza preoccuparti di doverla ricaricare frequentemente. Inoltre, l'impostazione di multi-modi ti permette di adeguare l'illuminazione alle tue esigenze, rendendola adatta a diverse situazioni, sia in campeggio che a casa.





POLLUX

ART. 0720063N.C20

€ TBC
12 / 48 / -

- 1000mAh Li-Ion
- 20-150 lumen
- 5-20 h
- 6
- Ø 8,7 x H5,7/10,8 cm
- 177 g
- 3W



SONNIK

ART. 0720069N

€ TBC
12 / 24 / -

- 4000mAh Li-Ion
- 60-200 lumen
- 12-25 h
- 14
- Ø 9 x H9,84 cm
- 220 g



Lampada da campeggio all'avanguardia progettata per gli appassionati Outdoor. Questa lampada ricaricabile è dotata di una cellula fotovoltaica integrata e di compatibilità USB, per garantire un'alimentazione costante. Con 4 impostazioni di luce, offre un'illuminazione versatile per qualsiasi situazione. È possibile appenderla facilmente grazie al gancio integrato o posizionarla in modo sicuro su un piano d'appoggio. Realizzato in plastica resistente, il suo design elegante e contemporaneo si abbina perfettamente alle vostre uscite all'aperto.

CARATTERISTICHE:

- Robusta e pratica
- Cellula fotovoltaica per l'alimentazione
- Porta di ricarica USB
- Gancio per appenderla
- Diverse modalità di luce
- Fino a 25 ore di luce con una carica completa
- Impermeabile e antipolvere

Lanterna solare LED con paralume collassabile. Molto compatta quando richiusa. Leggera e semplice da riporre. Completa di interruttore ON/OFF e gancio per appenderla. Si ricarica mediante cellula fotovoltaica integrata o presa USB.



AURA

ART. 0720067N

€ TBC
12 / 24 / -

- 3,7V Li-Ion - 2000mAh
- 300 lumen
- 8-20 h
- 6
- Ø 7,84/14,76 x H3,64/11 cm
- 210 g



BLAZE LED

ART. 0720032N.C20

€ TBC
6 / 12 / 144

- 3,7V / 4000mAh RG Li-Ion
- 600 lumen
- 12 h
- 4
- Ø 130 x H210 mm
- 900 g
- 20W



Lampada ripiegabile in silicone: una soluzione di illuminazione innovativa e versatile per tutti gli appassionati di outdoor. Realizzato in materiale resistente, questo paralume in silicone offre la massima visibilità negli ambienti più bui. È possibile scegliere tra due impostazioni di luce, che la rendono perfetta per qualsiasi ambiente. Il design pieghevole e salvaspazio la rende una scelta ideale per il campeggio, l'illuminazione della tenda o come lampada da tavolo.

Potente lanterna a LED indipendente o da appendere con robusto involucro in plastica per una posizione sicura e stabile. Con maniglia in metallo per il trasporto. 4 livelli di luminosità. Questa lanterna è adatta per una varietà di funzioni come il campeggio, la speleologia, la pesca ed altre attività all'aria aperta.

CARATTERISTICHE:

- Batterie ricaricabili
- Con presa USB









4 BRIGHTNESS LEVELS



NOCTILUS

ART. 0720060N

€ TBC
12 / 72 / -

-  3xAA (not incl.)
-  140 lumen
-  5-15 h
-  3x5050 SMD
-  Ø 7 x H4 cm
-  68 g









Lampada LED a sospensione per illuminare l'interno di tende a 360°. Funzionamento a batteria.



LUMINA

ART. 0720061N

€ TBC
8 / 32 / -

-  1xAA (not incl.)
-  25 lumen
-  8h+
-  1
-  Ø 6 x H10,5 cm
-  60 g
-  0,5W



Lampada per tende con interruttore a 3 livelli di luminosità e pratico gancio per appendere.



1 CLICK HIGH
2 CLICK LOW
3 CLICK FLASHING LIGHT









GLOBE LED

ART. 0720009N



€ TBC
10 / 50 / 400

-  3,7V 2400mAh
-  98-394 lumen
-  8-15 h
-  42
-  Ø 10,4 x H17,3 cm
-  180 g
-  21W



RECHARGEABLE
12V / 220V

Lampada LED a basso consumo energetico realizzata con corpo in resistente ABS e schermo in materiale plastico traslucido che genera una luce uniforme. Il pulsante ON-OFF integrato permette di selezionare più livelli di intensità luce per illuminare l'ambiente circostante in maniera ottimale. Completa di gancio in metallo per appenderla e presa Micro-USB per la ricarica. Facile da trasportare grazie alle sue dimensioni compatte. Ottima per l'utilizzo Outdoor e Camping.





STELLA

ART. 0720025N

€ TBC
6 / 6 / -

- 3600mAh
- 600 lumen
- 6-12h
- 63 x 2
- Ø 13 x 5,5 cm
- 250 g
- 4W



Lampada multifunzionale Outdoor che offre un'eccezionale versatilità e consente di utilizzarla in posizione verticale o appesa per un'illuminazione ottimale. Caratterizzata da un elegante design di colore bianco, la lampada è dotata di una base magnetica che consente di posizionarla comodamente su qualsiasi superficie metallica. Alimentata da una batteria ricaricabile, questa lampada a LED garantisce prestazioni affidabili e durature, rendendola il compagno perfetto per tutte le attività all'aperto.

CARATTERISTICHE:

- Utilizzabile come power bank
- Con cinghia per essere appesa e fissaggio magnetico
- 3 temperature di colore (3000/4000/6000 Kelvin)



SYRMA LED

ART. 7521018N

€ TBC
5 / 20 / 360

- 230 V
- 520 lumen
- 32
- Ø 18,5 X H12 cm
- 350 g
- 15W



COLORS



DIMMERABLE
0-100%

Lampada LED per tende e verande. Corpo pieghevole in silicone (sistema Fold-Away).

CARATTERISTICHE:

- Corpo in silicone
- Moderna tecnologia LED per oscuramento graduale (dimmer)
- Con gancio di sospensione e cavo di collegamento da 5 m
- Sistema di regolazione dell'altezza
- Interruttore ON-OFF



TABIT

ART. 0720012N

€ TBC
20 / 60 / -



- 3xLR3/AAA (not incl.)
- 39 g
- 75 lumen
- 3



Lampada frontale ultraleggera e molto compatta. Funzionamento a batteria.

CARATTERISTICHE:

- Lampada frontale LED con luce bianca (2X) rossa (1X)
- Riflettore orientabile
- Cinghia di fissaggio regolabile



SLEEP & RELAX

**SACCHILETTO
MATERASSINI
AMACHE**



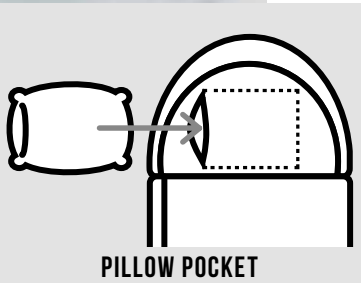

PILLOW POCKET



DETACHABLE HOOD

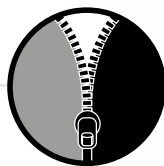

CAN BE COUPLED



SKIN-FRIENDLY LINER



CARRY BAG



STARFLYER
INFO P. 124



SACCO A PELO



DETACHABLE HOOD











PILLOW POCKET

STARFLYER

ART. 0428038N

€ TBC
4 / 4 / -

-  220 x 85 cm
-  Ø 42 x H22 cm
-  1,5 kg
-  2+1
-  100% Cotton
-  240T Nylon Ripstop
-  1000g Microfiber 100% - Polyester
-  Cold side -13 / 2 / 7 - Hot side 2 / 12 / 16



STARFLYER XL

ART. 0428039N

€ TBC
2 / 2 / -

-  235 x 105 cm
-  Ø 47 x H 26 cm
-  1,95 kg
-  2+1
-  100% Cotton
-  240T Nylon Ripstop
-  1700g Microfiber 100% - Polyester
-  Cold side -16 / 1 / 4 - Hot side 0 / 11 / 14



CAN BE COUPLED

Sacco a pelo leggero e confortevole per le notti estive e i soggiorni in camping. I due strati di imbottitura offrono un calore piacevole e accogliente per tutta la notte. Quando lo spazio è limitato, il cuscino integrato e il sacco di compressione incluso semplificano il trasporto. Cappuccio con cerniera. Il sacco a pelo Starflyer può essere facilmente trasformato in una coperta.

CARATTERISTICHE:

- Sacco a pelo rettangolare leggero per le notti estive
- Reversibile
- Struttura a 2 strati sul lato superiore - struttura a 1 strato sul lato inferiore
- Imbottitura molto morbida
- Utilizzabile dalla tarda primavera all'inizio dell'autunno (2/3 stagioni)
- Cappuccio staccabile (cerniera)
- Può essere utilizzato come coperta quando è aperto
- Cuscino integrato
- Cerniera: YKK. a 2 vie - Autolock- L-shape
- Accoppiabile
- Predisposto per lenzuolo interno
- Senza PFC
- Con sacca di compressione

Grazie alle sue dimensioni spaziose di 2,35 m di lunghezza, questo modello è particolarmente adatto alle persone più alte. Morbido e accogliente assicura sempre un sonno confortevole e può essere utilizzato sia all'aperto che al chiuso dalla primavera all'autunno (3 stagioni). In caso di basse temperature, il cappuccio può essere chiuso con una zip, mentre il comodo cuscino integrato evita di dover portare con sé un cuscino separato. Con un peso inferiore a 2 kg e la sacca di compressione inclusa, il sacco a pelo è caratterizzato da dimensioni particolarmente compatte che lo rendono facile da trasportare.

CARATTERISTICHE:

- Grande sacco a pelo rettangolare per persone alte
- Reversibile
- Struttura a 2 strati sul lato superiore - struttura a 1 strato sul lato inferiore
- Imbottitura molto morbida
- Utilizzabile dalla primavera all'inizio dell'inverno (3 stagioni)
- Cappuccio staccabile (zip)
- Può essere utilizzato come coperta quando è aperto
- Cuscino integrato
- Cerniera: YKK a 2 vie - Autolock - forma a L
- Senza PFC
- Con sacca di compressione

Il sacco a pelo è uno degli elementi più importanti dell'attrezzatura outdoor. Solo chi dorme e riposa bene può recuperare durante la notte ed iniziare il nuovo giorno in piena forma. La funzione di un sacco a pelo è relativamente semplice: conservare il calore del corpo e creare un clima piacevole all'interno del sacco stesso. I sacchi a pelo con imbottitura in fibra sintetica sono caratterizzati dal fatto che assorbono solo piccole quantità di umidità. Essi sono quindi adatti per l'uso in paesi o regioni con elevata umidità relativa ed un'alta probabilità di precipitazioni. Inoltre, il loro prezzo è solitamente più contenuto. I sacchi a pelo in piumino d'oca invece hanno più difficoltà con alti livelli di umidità. L'imbottitura rischia di diventare grumosa e quindi perdere il suo Loft e le sue proprietà di isolamento altrimenti eccellenti. Tuttavia, questo tipo di sacchi a pelo si distingue per il suo peso ridotto, la dimensione molto compatta quando chiusi ed il lungo ciclo di vita (se utilizzati e conservati correttamente).

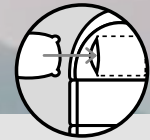

PILLOW POCKET



CAN BE COUPLED



VANDORA 70

ART. 0428035N

€ TBC
4 / 4 / -

-  220 x 80 cm
-  Ø 22 x H 18 cm
-  1,2 kg
-  1
-  100% Cotton
-  300T Polyester
-  700g Microfiber 100% - Polyester
-  -10 / 4 / 8



NEMOS 160

ART. 0428032N

€ TBC
3 / 3 / -

-  235 x 90 cm
-  48 x 46 x 27 cm
-  3 kg
-  2
-  Flannel
-  110/76 80/20TC
-  1600g Microfiber 100% - Polyester
-  -28 / -9 / -3

Il sacco a pelo Vandora è il compagno ideale per tutti i luoghi in cui lo spazio è ridotto, ad esempio nei van, nei minibus o nelle tende a tetto. Tuttavia, offre molto spazio e libertà di movimento per mettersi a proprio agio, oltre alla possibilità di aprirlo come una coperta e, non da ultimo, un formato molto compatto una volta riposto nel suo sacco di compressione. È dotato di una pratica tasca per il cuscino nel cappuccio e una tasca interna per i piccoli oggetti.

CARATTERISTICHE:

- Dimensioni compatte
- Struttura a 1 strato
- Cappuccio staccabile (cerniera)
- Può essere usato come coperta quando è aperto
- Cerniera: YKK a 2 vie - Autolock - forma a L
- Predisposto per lenzuolo interno
- Senza PFC
- Con sacco a compressione



2-WAY ZIPPER

Per i campeggiatori più esigenti, il sacco a pelo rettangolare Nemos 160 è il partner ideale. Una scelta selettiva di materiali adatti assicura che l'utente sia tenuto al caldo in tutte e 4 le stagioni, fornendo allo stesso tempo una piacevole sensazione di comfort e benessere nelle notti più fredde. Se necessario, è possibile collegare 2 sacchi a pelo tramite una zip per formare un sacco a pelo doppio.

CARATTERISTICHE:

- Sacco a pelo confortevole ed efficiente dal punto di vista del calore con cappuccio
- Costruzione offset a 2 strati
- Può essere utilizzato come coperta quando è aperto
- Cuscino integrato
- Cappuccio staccabile (cerniera)
- Cerniera: YKK a 2 vie - Autolock - forma a L
- Predisposto per lenzuolo interno
- Accoppiabile
- Senza PFC
- Con borsa per il trasporto



LAGUNA LITE

ART. 0428003N

€ TBC
7 / 14 / 210

 185+25 x 75 cm

 Ø 14 x 24,5 cm

 720 g

 1

 Technical Cotton

 190T Polyester

 80 g/m² - Silk-like fiber

 **+10°C / +25°C**

Sacchetto a coperta estivo ed ultraleggero. Completo di pratico cappuccio.

MORGAN

ART. 0434015N

€ TBC
10 / 40 / -

 47,5 x 32,5 x H11,5 cm

 120 g

 100% PVC

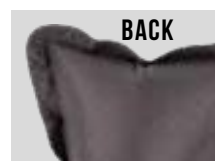

BACK

Cuscino poggiatesta gonfiabile con superficie vellutata piacevole al tatto.

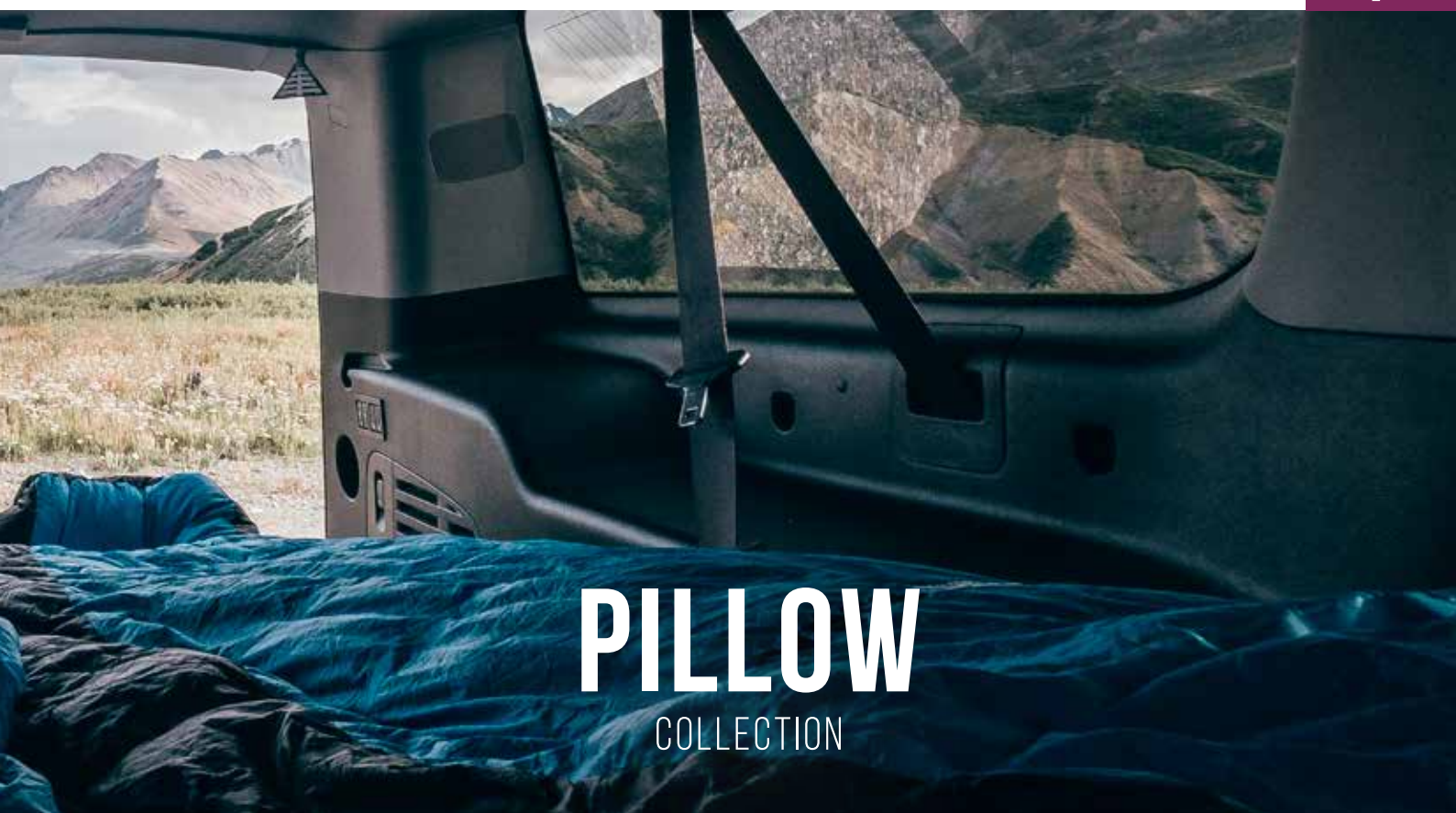

PILLOW

COLLECTION



MEMO TRAVEL

ART. 0434009N

€ TBC
5 / 20 / 160

 37 x 28 x 10 cm

 460 g

 100% Polyester + Aloe Vera



MEMO CAMPER

ART. 0434010N

€ TBC
5 / 10 / 80

 50 x 30 x 10/7 cm

 700 g

 75% Cotton 25% PES + Aloe Vera



Cuscino compatto in speciale schiuma ad alta densità Memory Foam.



MEMORY FOAM **45kg/m³**





SOMNI 3D



SOMNI 3D SINGLE

ART. 0432085N

€ TBC
4 / 4 / 36

200 x 76 x 10 cm

Ø 19 x 79 cm

3,2 kg

190T 75D Polyester

FRONT



BACK



SOMNI 3D DOUBLE

ART. 0432089N

€ TBC
2 / 2 / 12

200 x 132 x 10 cm

Ø 27 x 68 cm

5,7 kg

190T 75D Polyester

FRONT



BACK

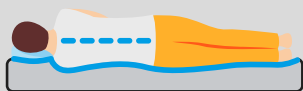

Materasso autogonfiante di nuova concezione. Molto confortevole, con un eccezionale rapporto tra peso complessivo e materiale isolante ottenuto mediante l'utilizzo di uno strato continuo di schiuma isolante in cui scorrono i flussi d'aria orizzontali. Realizzato in tessuto in poliestere con rivestimento superiore ad effetto peach skin. Ideale per un riposo ottimale. Grazie ad una particolare valvola bidirezionale, che al bisogno blocca o permette il flusso d'aria, il materasso si gonfia autonomamente. Per sgonfiarlo è sufficiente arrotolarlo chiudendo la valvola a fine operazione, sarà quindi poi riponibile occupando poco spazio. Completo di sacca custodia. Disponibile in 2 misure.

SELF-INFLATING SYSTEM



WITH FOAM CUT

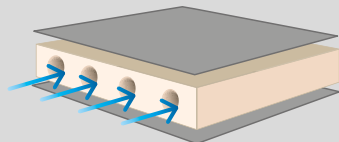





DEFLATION



I nostri materassini ad aria Flair sono realizzati con una soffice superficie in velluto e di resistente PVC. Dispongono di grosse valvole per un rapido gonfiaggio e sgonfiaggio. Ideali come letto per ospiti o per il campeggio.
* sgonfio

FLAIR

						M.O.	Master	
SINGLE BLUE	ART. 0432080N.C30	191 x 73 x 22 cm*	1,68 kg	100% PVC	€ TBC	6	6	144
DOUBLE BLUE	ART. 0432082N.C30	191 x 137 x 22 cm*	2,96 kg	100% PVC	€ TBC	4	4	80
SINGLE GREY	ART. 0432080N.C06	191 x 73 x 22 cm*	1,68 kg	100% PVC	€ TBC	6	6	144
DOUBLE GREY	ART. 0432082N.C06	191 x 137 x 22 cm*	2,96 kg	100% PVC	€ TBC	4	4	96
JUMBO	ART. 0432086N	203 x 157 x 38 cm*	4,96 kg	100% PVC	€ TBC	2	2	-



SINGLE GREY



DOUBLE GREY



SINGLE BLUE



DOUBLE BLUE



MAT PLUG BOSTON

ART. 0434007C
PACK 2X



€ TBC
10 / 80 / -

Tappi di ricambio per materassini in PVC fioccato.



JUMBO



INCLUDED ONLY FOR
JUMBO



INFO

MATERASSINI AD ARIA

I materassini ad aria, conosciuti anche come materassini gonfiabili, sono una comoda opportunità di riposo a basso costo per tutti i campeggiatori. Sono adattabili individualmente, proteggono tutto il corpo e consentono un sonno rilassato. Nell'assortimento Brunner sono presenti due tipi di materassini (materassini in PVC con superficie vellutata e materassini in cotone gommato). Entrambi i modelli sono disponibili in varie misure per soddisfare sia adulti che bambini, ma anche le coppie. Gli svantaggi dei materassini ad aria sono il loro peso, la dimensione d'imballo ed il fatto che prima dell'uso debbano essere gonfiati (non dimenticare la pompa d'aria). I materassini ad aria con superficie vellutata sono adatti anche per casa come letto d'emergenza per amici e parenti. Da considerare che i materassini ad aria non sono adatti all'utilizzo in acqua. Per questi casi esistono semplici materassini in PVC.



SUSSURRO

ART. 0436006N

€ TBC
12 / 24 / 288

5000 CC

650 g

Gonfiatore a mantice con robuste basi antisdrucciolo in materiale plastico. Completo di adattatori.



TEMPEST RG USB

ART. 0436016N

€ TBC
10 / 20 / -

8 x 7,5 x 10,5 cm

280 g

RG

38 W

l/min 270 l/min

Potente pompa 5V con interruttore ON-OFF. Completa di adattatore USB-C. Con borsa.

USB
charge

RECHARGEABLE



WHISPER ALU

ART. 0436002N

€ TBC
6 / 6 / 60

1x 3000 CC

10 x 22 x 54 cm

1,2 kg

Pompa aria con pistone in alluminio e set adattatori.



WHISPER

ART. 0436003N

€ TBC
6 / 6 / 60

2x 2000 CC

12 x 22 x 45 cm

800 g

Pompa doppia azione. Con set adattatori.



MOFLATE

ART. 0412022N

€ TBC
4 / 16 / 336

200 x 70 x H8 cm

27 x Ø 11,5 cm

900 g

40D Nylon / DPU

Materassino gonfiabile ultraleggero e super-compatto con pompa di gonfiaggio integrata. Ideale per tutte le attività outdoor e camping che richiedono un pernottamento. Ottima isolamento dall'umidità del terreno grazie alla speciale conformazione delle camere d'aria. Completo di sacca custodia.



INTEGRATED
CUSHION



AIR
PUMP
SYSTEM

I materassi ad aria Alveobed sono ideali compagni di viaggio durante attività Outdoor di ogni genere. Sacca custodia inclusa.





CARATTERISTICHE:

- Facile da usare
 - Dimensioni d'imballo salvaspazio
 - Resistente alle temperature
 - Robusto e resistente
 - Con pratica valvola Boston (Alveo Single, Alveo Double)
- * sgonfio

ALVEOBED SINGLE

ART. 0412027N





€ TBC
6 / 6 / 150

-  220 x 75 cm*
-  Ø 12,5 x 28 cm
-  1,45 kg
-  100% Polyester 190T/75D PVC Coating

ALVEOBED DOUBLE

ART. 0412028N





€ TBC
4 / 4 / 64

-  220 x 142 cm*
-  Ø 25 x 36 cm
-  3,3 kg
-  100% Polyester 190T/75D PVC Coating

ALVEOBED SINGLE IP

ART. 0412039N





€ TBC
6 / 6 / 96

-  220 x 75 cm*
-  Ø 12,5 x 28 cm
-  1,45 kg
-  100% PES / PVC Coating

ALVEOBED PILLOW

ART. 0412029N

€ TBC
12 / 12 / 456

-  60 x 40 cm
-  Ø 5 x 21 cm
-  200 g
-  100% Polyester 190T/75D TPU Coating

Cuscino Outdoor di alta qualità. Con borsa custodia.

ALVEOBED



BOSTON VALVE



AIR
PUMP
SYSTEM









MAT COLLECTION



ROAMAT

ART. 0412003N

€ TBC
12 / 12 / 96

-  180 x 50 x 1,2 cm
-  Ø 17 x 50 cm
-  390 g
-  100% EVA





Materassino bistrato in EVA a cellule chiuse.



KOALA

ART. 0412006N

€ TBC
30 / 30 / 120

-  180 x 50 x 0,7 cm
-  Ø 13 x 50 cm
-  190 g
-  100% EVA

Materassino monostrato in EVA a cellule chiuse. Liscio su entrambi i lati.



ALU-MAT

ART. 0412017C





PACK 1X

€ TBC
10 / 40 / -

ART. 0412017N

PACK -

€ TBC
10 / 50 / 600

-  180 x 50 x 0,7 cm
-  Ø 14 x 50 cm
-  190 g
-  100% PE





Materassino monostrato con film alluminizzato e goffratura sul lato superiore. Leggero e compatto.



ALU TRAMP

ART. 0412009N

€ TBC
6 / 24 / 144





-  190 x 55 x 0,3 cm
-  Ø 14 x 29 cm
-  138 g
-  PE / Alu

Stuoino isolante impermeabile con imbottitura.

GRENADA

ART. 0412030N

€ TBC
4 / 4 / 40





-  183 x 54 x 3 cm
-  28 x 54 x 18 cm
-  650 g
-  30% Cotton 70% Polyester 100% PVC

Materassino da spiaggia imbottito e foderato.

BONITA

ART. 0412031N

€ TBC
4 / 8 / 48





-  140 x 50 x 2 cm
-  50 x 23 x 11 cm
-  840 g
-  100% Polyester Oxford

Materassino con rivestimento in resistente tessuto anti-sdrucchiolo realizzato in Polyester Oxford.

MATERASSINI PICNIC PLAID

ART. 0428052N

€ TBC
5 / 10 / 120

-  200 x 150 cm
-  38 x 8 x 26 cm
-  720 g
-  100% Polyester







Coperta picnic leggermente imbottita.

CAYO

ART. 0412018N

€ TBC
12 / 24 / 144

-  180 x 200 cm
-  37 x 7 x 28 cm
-  720 g
-  100% PP

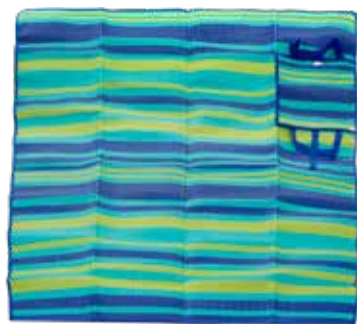





Stuoia spiaggia realizzata in tessuto PP flessibile, resistente e idrorepellente. Design moderno. Pratica da riporre e trasportare.

TJAGO

ART. 0428061N

€ TBC
10 / 10 / -

-  145 x 200 cm
-  34 x 8 x 18,5 cm
-  500 gr
-  100% Polyester / PEVA



ASSORTED







Coperta picnic arrotolabile realizzata in resistente tessuto di poliestere e lato inferiore idrorepellente.

ALFRESCO

ART. 0428054N

€ TBC
6 / 6 / -

-  200 x 150 cm
-  30 x 15 x 21 cm
-  500 g
-  100% Polyester Fleece / Peva



ASSORTED



Coperta da picnic con superficie soffice e morbida in resistente fibra sintetica idrorepellente. Il lato inferiore ha un rivestimento impermeabile. Con maniglia per il trasporto.

PRAIA

ART. 0412025N

€ TBC
6 / 12 / 240

-  180 x 85 cm
-  Ø 5 x 85 cm
-  320 g
-  100% PP







Stuoia per spiaggia realizzata in resistente tessuto polipropilenico.

OASIS ALU

ART. 0412019N

€ TBC
12 / 24 / 432

-  180 x 80 cm
-  Ø 6 x 80 cm
-  480 g
-  Natural Fiber / Alu Foil



Stuoia spiaggia in fibra vegetale, alluminizzata su un lato.



MOSQUITO PROTECTION

COLLECTION



TROPICANA

ART. 0202087N

€ TBC

8 / 16 / 208

Ø 60 x 900 x H250 cm

600 g

100% PES



256

FORI POLLICE

Zanzariera da viaggio con ventaglio di tensione e custodia. Adatta per letti doppi.

POP UP SINGLE

ART. 0202089N

€ TBC

6 / 6 / 126

Ø 50 x 900 x H250 cm

385 g

100% PES

POP UP DOUBLE

ART. 0202090N

€ TBC

6 / 6 / 126

Ø 50 x 1500 x H250 cm

720 g

100% PES

Zanzariera da viaggio con anello di tensione pieghevole (sistema POP UP ad apertura automatica).



CITRONELLA CANDLE S

ART. 0205055N

€ TBC

12 / 48 / 2304

Ø 6,5 x H6 cm

12 g

Candela alla citronella avvolta in elegante contenitore di melamina.

CARATTERISTICHE:

- Contiene olio di citronella



CITRONELLA CANDLE M

ART. 0205056N

€ TBC

12 / 48 / 1200

Ø 10 x H8,5 cm

18 g



MOSSY BOX

ART. 0205011C

€ TBC

12 / 60 / -

Ø 130 x H50 mm

100 g

PACK 1X

Contenitore per zampironi in materiale plastico termoresistente. Spirali escluse.

OUTDOOR COT



OUTDOOR COT

ART. 0410032N.C30

€ TBC
2 / 2 / 38
 190 x 64/72 x H43 cm

 95 x 21 x H14 cm

 4,8 kg



Letto da campo con struttura pieghevole e smontabile in alluminio.

OUTDOOR COT XL2

ART. 0410045N

€ TBC
2 / 2 / 36
 210 x 80 x H50 cm

 103 x 20 x 12 cm

 6,5 kg



Letto da campo di ampie dimensioni. Telaio in alluminio anodizzato.

OUTDOOR COT AUTOMATIC

ART. 0410044N

€ TBC
2 / 2 / 40
 191 x 66 x H44 cm

 105 x 15 x H15 cm

 8,9 kg

Letto da campo robusto con struttura pieghevole appositamente progettata per essere aperta e ripiegata in un istante. Comoda tela in resistente tessuto di poliestere con poggiatesta integrato e imbottito. Di dimensioni compatte quando ripiegato. Con pratica borsa per il trasporto.

INFO

IL LETTINO DA CAMPO

I lettini da campo danno la possibilità di dormire in modo comodo e sicuro, ben rialzati dal terreno. Soprattutto in caso di maltempo si è protetti dal bagnato e dall'umidità. Inoltre non si è a contatto con fastidiosi insetti. A seconda del modello di lettino esiste la possibilità di stivare attrezzatura sotto al telo per dormire. Come per ogni acquisto di attrezzatura, sono molte le considerazioni da fare nella scelta di un lettino da campo. Ogni modello presente nel nostro catalogo ha dei vantaggi e svantaggi. E' soprattutto importante ragionare sul mezzo che verrà utilizzato per trasportare il lettino da campo: alcuni diventano molto piccoli perchè si possono scomporre o ripiegare, altri sono solo pieghevoli, con misure meno compatte, ma solitamente più confortevoli.



BELHAM



ultralight



REEL



2X
CARABINERS



2X LOOPED
STRAPS 6
RINGS



280
CM



210T
Parachute
Fabric



BELHAM SINGLE

ART. 0414005N

€ TBC

4 / 20 / 240

- 270 x 140 cm
- 22 x 14 x 5 cm
- 500 g
- 300 kg

BELHAM DOUBLE

ART. 0414006N

€ TBC

4 / 20 / 240

- 300 x 200 cm
- 24 x 16 x 6 cm
- 710 g
- 300 kg

Amaca da viaggio realizzata in tessuto sintetico ultraleggero e super resistente. Dotata di ampia superficie di sdraio ed una capacità di carico massima di 300 kg. Molto compatta da trasportare mediante una pratica sacca custodia inclusa nella fornitura che funge anche da piccola tasca per riporre gli occhiali da sole, il cellulare, gli spiccioli, ecc. Perfetta per outdoor, camping, moto e cicloturismo. Disponibile in versione singola e doppia. Accessori di fissaggio inclusi.

VOYAGER

ART. 0414009N

€ TBC

6 / 12 / 408

- (52,5+225+52,5) x 147 cm
- 21 x Ø 7 cm
- 380 g
- 100 kg
- Nylon 100% PA



Amaca ultraleggera di dimensioni molto compatte.

RAINMAN

ART. 8410011N

€ TBC

9 / 9 / 882

- 203 x 127 cm
- 200 g
- 100% PVC



Poncho impermeabile. Colori assortiti: blu, verde.



BEAUTY CASE

COLLECTION



BODY&SOUL

ART. 9004015N.C73

€ TBC
5 / 30 / -

25,5 x 12 x 48,5 cm

25,5 x 12 x 15 cm

350 g

PVC / Polyester

Pratico necessaire da viaggio realizzato in resistente tessuto a doppia spalmatura.

HOLIDAY

ART. 9004016N.C73

€ TBC
5 / 30 / 300

26 x 14 x 37 cm

25 x 13 x 28 cm

415 g

PVC / Polyester

Il beauty-case imbottito offre ampio spazio per una lunga vacanza.

WASH BAG

ART. 9004018N.C73

€ TBC
5 / 30 / -

25,5 x 44 cm

25,5 x 16 cm

210 g

PVC / Polyester

Beauty-case con specchietto interno. Gancio in metallo. Vari scomparti e tasche con cerniera interni. Chiusura a fibbia.



DRYZAK



M.O.

Master



DRYZAK M ART. 0202229N 36l Polyester / PVC € TBC 5 20 500

DRYZAK L ART. 0202230N 62l Polyester / PVC € TBC 5 20 500

Sacca impermeabile con cuciture saldate e pratica chiusura ad arrotolamento con fibbia.





OUTDOOR FURNITURE

**SEDIE E LETTINI
TAVOLI
ARMADI E MOBILETTI CUCINA**



10 POSITIONS

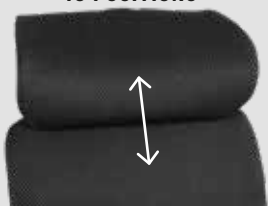

ADJUSTABLE HEADREST



HIGH-QUALITY ARMRESTS

STURDY FRAME MADE
FROM ALUMINIUMBIG FOOTPADS AVOID
SINKING IN SOFT GROUNDERGONOMICALLY SHAPED BACK
SECTION WITH INTEGRATED
LUMBAR SUPPORTREBEL H2L
INFO P. 147

CHAIR COLLECTION

FOLDING OUTDOOR CHAIRS

La nostra gamma di sedie comprende una varietà di modelli che hanno funzioni diverse a seconda delle dimensioni, del peso, delle dimensioni dell'imballaggio o del comfort. Quando si sceglie una sedia da tavolo, si dovrebbe prevedere uno schienale verticale, mentre una sedia Outdoor pura deve essere leggera con una piccola dimensione di imballaggio. D'altra parte, una sedia relax deve avere una seduta più ampia e uno schienale comodamente reclinabile. Per facilitare la scelta della sedia giusta, abbiamo elaborato una panoramica che mostra tutte le caratteristiche importanti dei modelli di sedia Brunner ed il loro uso ideale.



CHAIR 4 ALL

ERGONOMIC CONCEPT

DI QUALI DIMENSIONI DI SEDIA AVETE BISOGNO?

Sei seduto comodamente? La dimensione della sedia riveste sempre un ruolo importante! Molti di noi passano molte ore in posizione seduta durante il giorno. Al lavoro, a casa, a tavola o mentre ci rilassiamo: dovremmo fare attenzione a star seduti comodamente, per evitare tensioni e per aumentare il nostro benessere.

Fondamentalmente, non si può formulare uno statement generale sulla giusta posizione di seduta. La taglia del corpo, le proporzioni del corpo e anche l'altezza del tavolo giocano un ruolo importante.

Ci sono quindi molte ragioni che ci fanno riflettere sulla giusta dimensione di una sedia. Non solo il comfort, la meccanica e il design attraente della vostra sedia Outdoor, ma anche una postura ergonomica dovrebbero essere un importante criterio di selezione. Grazie alle nuove taglie sviluppate, la collezione di sedie Aravel / Rebel Pro certamente dispone della sedia giusta per la vostra taglia. Molto importante: la giusta altezza della seduta influisce positivamente sul benessere!

Fate attenzione che i vostri piedi siano comodamente appoggiati al pavimento e che gli avambracci formino un angolo retto con la parte superiore del braccio. Quindi la sedia giusta non solo deve piacere, ma deve anche essere davvero la scelta giusta per te e per le tue misure corporee.

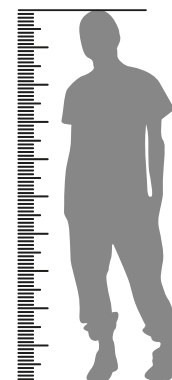
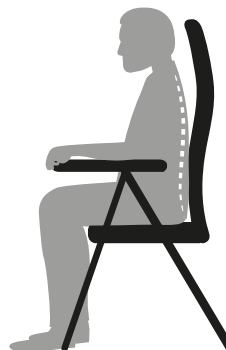

originaldesign ➤

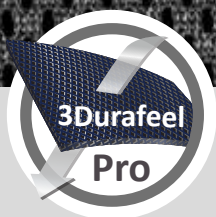

3DURAFEEL PRO

REBEL / ARAVEL VITACHIC

Il tessuto di rivestimento 3Durafeel Pro è un tessuto molto speciale utilizzato nelle nostre collezioni di sedie Rebel e Aravel. Grazie alla sua permeabilità all'aria e alla delicatezza sulla pelle, trasforma il comfort in una meravigliosa esperienza di seduta per ore di relax all'aperto. 3Durafeel Pro si asciuga incredibilmente in fretta anche dopo una leggera pioggia e irradia una piacevole atmosfera di benessere sulla veranda, sulla terrazza o sul balcone. E questo in modo affidabile per molti anni. Infatti, 3Durafeel Pro è resistente allo strappo e all'abrasione, traspirante, resistente alla luce e repellente allo sporco. Costruzione monostrato (trama speciale).

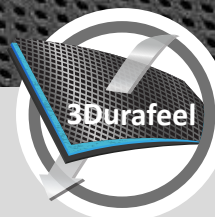

3DURAFEEL

ARAVEL / SKYE

Il tessuto di rivestimento 3Durafeel è un tessuto molto speciale utilizzato nelle nostre collezioni di sedie Aravel e Skye. Grazie alla sua permeabilità all'aria e alla delicatezza sulla pelle, trasforma il comfort in una meravigliosa esperienza di seduta per ore di relax all'aperto. 3Durafeel si asciuga incredibilmente in fretta anche dopo una leggera pioggia e irradia una piacevole atmosfera di benessere sulla veranda, sulla terrazza o sul balcone. E questo in modo affidabile per molti anni. Infatti, 3Durafeel è resistente allo strappo e all'abrasione, traspirante, resistente alla luce e repellente allo sporco. Costruzione a tre strati.



ARAVEL VITACHIC

DARK GREY
SALT & PEPPER

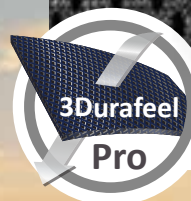

C69

C42



S M L



COLORS
C69 C42



COLORS
C69 C42



COLORS
C69 C42

ARAVEL VITACHIC S

ART. 0404065N

€ TBC
2 / 2 / 16

- 41 x 44 x 46,5/116 cm
- 106,5 x 59,5 x 10 cm
- 5,2 kg

ARAVEL VITACHIC M

ART. 0404065N

€ TBC
2 / 2 / 16

- 47 x 44 x 48/121 cm
- 114 x 64,5 x 10 cm
- 5,3 kg

ARAVEL VITACHIC L

ART. 0404065N

€ TBC
2 / 2 / 16

- 49 x 44 x 50/126 cm
- 117,5 x 67,5 x 10 cm
- 5,58 kg

OPTIONAL



COLORS
C69 C42

ARAVEL VITACHIC STANDALONE

ART. 0404073N

€ TBC
6 / 6 / 48

- 61 x 49 x H49 cm
- 67 x 60 x 8 cm
- 2,1 kg

Poggiatesta indipendente con struttura pieghevole in alluminio verniciato a polvere e rivestimento in tessuto 3Durafeel Pro di alta qualità. Utilizzabile anche come sgabello.

La sedia pieghevole Aravel Vitachic è realizzata con uno schienale alto regolabile (7 posizioni) e con la nostra speciale imbottitura 3Durafeel Pro che offre un massimo di comfort durante tutte le stagioni. Dotata di un telaio ultraleggero pieghevole in alluminio che ne consente un rapido e semplice processo di apertura e ripiegamento. Disponibile nelle versioni S-M-L.

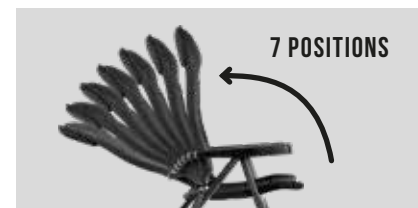

7 POSITIONS



ARAVEL VITACHIC STOOL

ART. 0404078N.C69

€ TBC
6 / 6 / 84

- 27 x 40 x H45 cm
- 42 x 60 x 4 cm
- 1,2 kg

Sgabello pieghevole con struttura in alluminio e seduta realizzata in tessuto speciale 3Durafeel PRO.

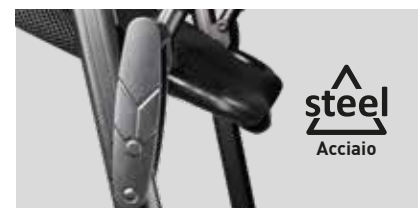

steel
Acciaio



C09



ARAVEL

BLACK



S M L



ARAVEL 3D S

ART. 0404065N.C09S

€ TBC
2 / 2 / 16

- 41 x 44 x H46,5/116 cm
- 106,5 x 59,5 x 10 cm
- 5,2 kg

ARAVEL 3D M

ART. 0404065N.C09M

€ TBC
2 / 2 / 16

- 47 x 44 x H48/121 cm
- 114 x 64,5 x 10 cm
- 5,3 kg

ARAVEL 3D L

ART. 0404065N.C09L

€ TBC
2 / 2 / 16

- 49 x 44 x H50/126 cm
- 117,5 x 67,5 x 10 cm
- 5,58 kg



ARAVEL 3D STOOL

ART. 0404084N.C09

€ TBC
6 / 6 / 84

- 27 x 40 x H45 cm
- 42 x 60 x 4 cm
- 1,2 kg



ARAVEL STOOL XL

ART. 0404057N.C09

€ TBC
6 / 6 / -

- 46 x 30 x H45 cm
- 46 x 6 x 60 cm
- 1 kg

Sgabello pieghevole Aravel 3D.

CARATTERISTICHE:

- Struttura in alluminio
- Telo portante in tessuto 3D imbottito e traspirante.
- Compatto e comodo da trasportare quando ripiegato

La versione XL del nostro apprezzato sgabello pieghevole Aravel. Più comfort con una maggiore capacità di carico.

Moderna sedia pieghevole a 4 gambe con schienale reclinabile a 7 posizioni.

CARATTERISTICHE:

- Struttura in profilo di alluminio ad alta portata
- Telo portante in tessuto 3D imbottito e traspirante
- Schienale ergonomico e reclinabile a 7 posizioni
- Schienale con poggiatesta imbottito integrato
- Braccioli in resistente materiale plastico
- Snodo centrale in acciaio
- Possibilità di collegare un poggiatesta
- Compatta e comoda da trasportare quando ripiegata



OPTIONAL



ARAVEL UNIVERSAL FOOTREST

ART. 0404079N.C09

€ TBC
6 / 6 / 36

- 43 x 95 x H47/44 cm
- 43 x 95 x 7 cm
- 1,1 kg

Poggiatesta pieghevole universale per sedie Aravel 3D (S-M-L).

CARATTERISTICHE:

- Struttura in alluminio
- Telo portante in tessuto 3D imbottito e traspirante
- Compatto e comodo da trasportare quando ripiegato

ARAVEL

BLACK

C09



NOT AVAILABLE
IN SOME
EU COUNTRIES



SWAN 3D

ART. 0404071N.C09

€ TBC
1 / 1 / 12

50 x 49 x H48/116 cm

95 x 74 x 13,5 cm

8,0 kg

ARAVEL HIGH DUNA 3D

ART. 0410062N.C09

€ TBC
1 / 1 / 10

198 x 64 x H48/103 cm

84 x 12 x 72 cm

8 kg

Poltrona Relax che meglio offre un grado di comfort di altissimo livello. Costruzione stabile e robusta con struttura pieghevole in alluminio. Braccioli larghi e confortevoli.

CARATTERISTICHE:

- Schienale regolabile senza scatti con leva di bloccaggio
- Aperta e pronta all'uso in pochissimi secondi
- Non necessita di premontaggio
- Facile da trasportare

Letto di alta qualità con struttura in alluminio verniciato a polvere e pratico tettuccio parasole. Grazie alla sua ampia e alta superficie, salire e scendere è eccezionalmente facile e senza alcuna difficoltà. Inoltre, la superficie di sdraio rivestita in tessuto 3D imbottito offre un elevato grado di comfort. Il poggiatesta è regolabile a 5-posizioni. Dopo l'uso, il lettino da sole può essere facilmente ripiegato, trasportato e riposto per risparmiare spazio.

OPTIONAL



ARAVEL 3D FOOTREST

ART. 0404099N.C09

€ TBC
6 / 6 / 54

51 x 71 x H48/43 cm

51 x 71 x 6 cm

1,35 kg

Poggiatesta pieghevole per sedia Aravel 3D M.

CARATTERISTICHE:

- Struttura in alluminio
- Telo portante in tessuto 3D imbottito e traspirante
- Compatto e comodo da trasportare quando ripiegato



ARAVEL 3D

STANDALONE FOOTREST

ART. 0404073N.C09

€ TBC
6 / 6 / 48

61 x 49 x H49 cm

67 x 60 x 8 cm

2,1 kg

Poggiatesta autoportante a 4 gambe con copertura FULL-3D traspirante con telaio in alluminio verniciato a polvere.





C07



ARAVEL

WARM GREY



360°

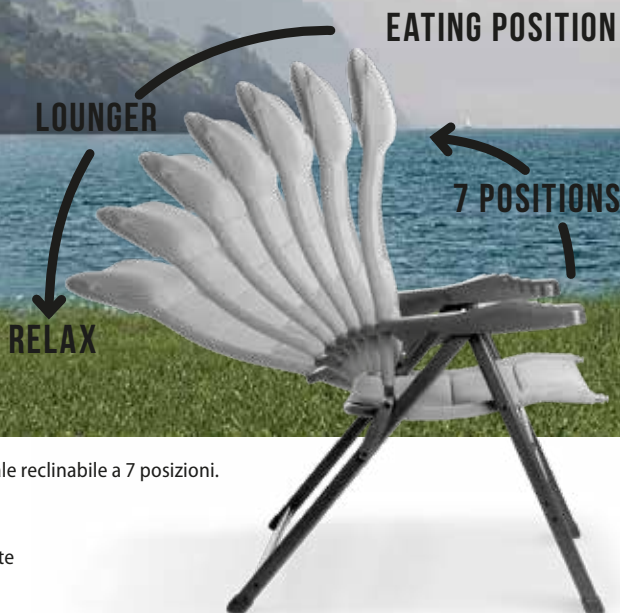

Moderna sedia pieghevole a 4 gambe con schienale reclinabile a 7 posizioni.

CARATTERISTICHE:

- Struttura in profilo di alluminio ad alta portata
- Telo portante in tessuto 3D imbottito e traspirante
- Schienale ergonomico e reclinabile a 7 posizioni
- Schienale con poggiatesta imbottito integrato
- Braccioli in resistente materiale plastico
- Snodo centrale in acciaio
- Possibilità di collegare un poggiamambe
- Compatta e comoda da trasportare quando ripiegata

ARAVEL 3D M

ART. 0404065N.C07M

€ TBC
2 / 2 / 16

- 📏 47 x 44 x H48/121 cm
- 📏 114 x 64,5 x 10 cm
- 📏 5,3 kg



ARAVEL 3D STOOL

ART. 0404084N.C07

€ TBC
6 / 6 / 84

- 📏 27 x 40 x H45 cm
- 📏 42 x 60 x 4 cm
- 📏 1,2 kg



ARAVEL STOOL XL

ART. 0404057N.C07

€ TBC
6 / 6 / -

- 📏 46 x 39 x H47 cm
- 📏 46 x 6 x 60 cm
- 📏 1 kg

Sgabello pieghevole Aravel 3D.

CARATTERISTICHE:

- Struttura in alluminio
- Telo portante in tessuto 3D imbottito e traspirante.
- Compatto e comodo da trasportare quando ripiegato

La versione XL del nostro apprezzato sgabello pieghevole Aravel. Più comfort con una maggiore capacità di carico.



OPTIONAL

ARAVEL 3D STANDALONE

ART. 0404073N.C07

€ TBC
6 / 6 / 48

- 📏 61 x 49 x H49 cm
- 📏 67 x 60 x 8 cm
- 📏 2,1 kg

Poggiatesta autoportante a 4 gambe con copertura FULL-3D traspirante con telaio in alluminio verniciato a polvere.

ARAVEL 3D FOOTREST

ART. 0404099N.C07

€ TBC
6 / 6 / 54

- 📏 51 x 71 x H48/43 cm
- 📏 51 x 71 x 6 cm
- 📏 1,35 kg

Poggiamambe pieghevole per sedia Aravel 3D M.

CARATTERISTICHE:

- Struttura in alluminio
- Telo portante in tessuto 3D imbottito e traspirante
- Compatto e comodo da trasportare quando ripiegato

ARAVEL H2L

DARK GREY

originaldesign ➤

C25

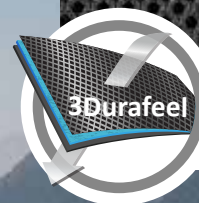

ARAVEL H2L

ART. 0404052N.C25

€ TBC
2 / 2 / 16

🔒 48 x 44 x H48/110-122 cm

🔒 98 x 64,5 x 10 cm

📦 5,30 kg

Aravel H2L è la sedia da campeggio pieghevole per eccellenza, perfetta per tutte le avventure outdoor. Questa sedia di alta qualità non solo è resistente e confortevole, ma è anche dotata di un poggiatesta regolabile in altezza e salvaspazio per essere riposta facilmente. Grazie alla struttura robusta e ai materiali durevoli, potrete godere del massimo sostegno e comfort ovunque vi troviate. Non accontentatevi di poco: scegliete la nostra sedia da campeggio pieghevole per la vostra prossima avventura e godetevi il massimo del relax.

ARAVEL CAMPER

ART. 0404093N.C25

€ TBC
2 / 2 / 14

🔒 60 x 72 x H45/105 cm

🔒 85 x 60 x 9 cm

📦 4,3 kg

La sedia pieghevole Aravel Camper è stata progettata con un telaio a forma di U che assicura una grande stabilità ed è quindi perfetta per tutti i vostri viaggi e spostamenti. Il suo tessuto 3Durafeel garantisce una lunga durabilità, assicurando un comfort inalterato anche in condizioni difficili. E con il poggiatesta in dotazione, il relax è assicurato. Dimensioni di stoccaggio ridotte.



OPTIONAL

ARAVEL H2L STANDALONE

ART. 0404066N.C25

€ TBC
6 / 6 / 24

🔒 61 x 47 x H49 cm

🔒 65 x 61 x 8 cm

📦 2,2 kg

Il poggiatesta di ultima generazione per il massimo del comfort e della praticità! Il nostro poggiatesta indipendente è dotato di un robusto telaio in alluminio pieghevole per essere riposto e trasportato facilmente. Il pratico vassoio in rete vi permette di gustare i vostri snack o le vostre bevande preferite senza mai lasciare il vostro posto accogliente. Dite addio alle posizioni scomode e date il benvenuto a un beato relax con il nostro pratico poggiatesta.

MARBELLA HIGH H2L

ART. 0410023N.C25

€ TBC
1 / 1 / -

🔒 202 x 67 x H48 cm

🔒 69 x 86 x 22 cm

📦 8,5 kg

Il lettino prendisole Marbella High H2L offre un'esperienza di relax all'aperto davvero indimenticabile. La sua struttura di alta qualità è dotata di un poggiatesta regolabile in altezza per un comfort personalizzabile e di un telaio in alluminio pieghevole per facilitarne il trasporto. Progettato con una superficie di appoggio alta, questo lettino è perfetto per la spiaggia, la piscina o il giardino. Il Marbella High H2L combina funzionalità ed estetica, rendendolo una scelta versatile e affidabile per le vostre esigenze di relax all'aperto.

CARATTERISTICHE:

- Schienale con poggiatesta regolabile in altezza
- Superficie di appoggio alta
- Telaio pieghevole in alluminio
- Dispone di un parasole incorporato



**C69****C51**

360°

**S M L****REBEL SMALL**

COLORS



ART. 0404002N

€ TBC
2 / 2 / 14

46 x 44 x H46/117,5 cm

110 x 60 x 12 cm

5,5 kg

**REBEL MEDIUM**

COLORS



ART. 0404002N

€ TBC
2 / 2 / 14

48 x 46 x H48,5/123 cm

114 x 65 x 12 cm

6,1 kg

**REBEL LARGE**

COLORS



ART. 0404002N

€ TBC
2 / 2 / 14

54 x 45 x H51,5/125 cm

117 x 71 x 12 cm

6,5 kg

Sedia pieghevole di ultima generazione con struttura in alluminio verniciato a polvere, copertura FULL-3D traspirante e braccioli rinforzati in metallo per la regolazione dello schienale. Costruzione estremamente stabile e salvaspazio, abbinata ad un design moderno e funzionale.

CARATTERISTICHE:

- Sedia pieghevole a 4 gambe con schienale alto
- Schienale regolabile in 5 posizioni
- Snodo centrale in acciaio
- Braccioli in plastica di alta qualità con guida metallica
- Tessuto: FULL-3D traspirante, resistente ai raggi UV e ad asciugatura rapida
- Schienale ergonomico con supporto lombare integrato
- Poggiatesta imbottito e integrato
- Tasca organizer nella sezione posteriore
- Garanzia: 3 anni

**OPTIONAL****REBEL UNIVERSAL FOOTREST**

COLORS



ART. 0404003N

€ TBC
6 / 6 / 18

95 x H43 cm

95 x H10 cm

1,80 kg

REBEL STANDALONE FOOTREST

COLORS



ART. 0404004N

€ TBC
6 / 6 / 36

61 x 49 x H49 cm

65 x 61 x 8 cm

2,1 kg

Poggiagambe universale per la collezione di sedie Rebel nelle 3 varianti di misura S-M-L. Attacco a clip sulla traversa rotonda.

Poggiapiedi autoportante a 4 gambe con copertura FULL-3D traspirante con telaio in alluminio verniciato a polvere.

REBEL H2L

DARK GREY

C69

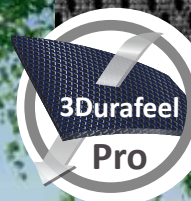

10 POSITIONS

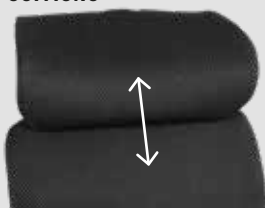

ADJUSTABLE HEADREST



originaldesign



HIGH-QUALITY ARMRESTS

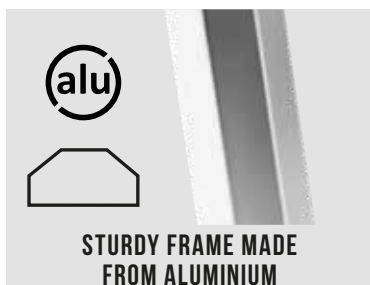

STURDY FRAME MADE FROM ALUMINIUM

REBEL H2L

ART. 0404001N.C69

€ TBC
2 / 2 / -

50 x 44 x H48/112-125 cm

100 x 65 x 12 cm

6,0 kg



OPTIONAL

REBEL H2L STANDALONE

ART. 0404066N.C69

€ TBC
6 / 6 / 24

61 x 47 x H49 cm

65 x 61 x 8 cm

2,2 kg

HOGGY REBEL STANDALONE

ART. 0404006N

€ TBC
4 / 4 / 40

64 x 51 x H5,5 cm

1,7 kg

Il poggiatesta di ultima generazione per il massimo del comfort e della praticità! Il nostro poggiatesta indipendente è dotato di un robusto telaio in alluminio pieghevole per essere riposto e trasportato facilmente. Il pratico vassoio in rete vi permette di gustare i vostri snack o le vostre bevande preferite senza mai lasciare il vostro posto accogliente. Dite addio alle posizioni scomode e date il benvenuto a un beato relax con il nostro pratico poggiatesta.

Grande tavolo per sgabello con profilo perimetrale in alluminio, progettato appositamente per il poggiatesta / sgabello indipendente Rebel.

Comodissima sedia 4 gambe a schienale alto con nuovissimo telaio salvaspazio che rappresenta la soluzione perfetta per chi non dispone di ampi spazi di stoccaggio nel proprio veicolo. Grazie a speciali snodi appositamente realizzati, è risultato possibile ripiegare sia la gamba posteriore della sedia che il poggiatesta, riducendo così in modo considerevole l'ingombro in altezza della sedia in posizione chiusa. Tutto ciò mantenendo assolutamente inalterate le caratteristiche di comfort ed eleganza proprie a tutti i modelli di sedia della collezione Rebel.

CARATTERISTICHE:

- Telaio in speciale profilo trapezoidale in alluminio verniciato
- Seduta e schienale in tessuto 3Durafeel Pro
- Poggiatesta pieghevole
- Gamba posteriore pieghevole
- Schienale regolabile (5 posizioni)
- Snodo centrale in acciaio
- Braccioli in plastica di alta qualità con guida metallica
- Schienale ergonomico con supporto lombare integrato
- Tasca organizer integrata nel retro dello schienale
- Compatibile con i poggiatesta della serie Rebel



C58



Licotex
73% PVC
27% PES

PHANTOM

BLACK



alu original design

OPTIONAL

PHANTOM

ART. 0404058N.C58

€ TBC
2 / 2 / 16

48 x 38 x H48/121 cm

65,5 x 8 x H112 cm

5,2 kg

Sedia pieghevole ultrapiatta con schienale reclinabile.

CARATTERISTICHE:

- Struttura in profilato ovale di alluminio
- Schienale reclinabile a 7 posizioni
- Ultrapiatta quando ripiegata
- Materiali di alta qualità
- Braccioli molto confortevoli
- Design moderno

PHANTOM FOOTREST

ART. 0404059N.C58

€ TBC
6 / 6 / 36

48 x 44 x 94 cm

11 x 44 x 93 cm

1,2 kg

Poggiapiedi pieghevole per sedia Phantom.



PHANTOM STOOL

ART. 0404053N.C58

€ TBC
6 / 6 / 96

27 x 40 x H45 cm

42 x 60 x 4 cm

1,1 kg

Robusto sgabello pieghevole con seduta in tessuto Licotex resistente alle intemperie. Telaio salvaspazio in tubo tondo di alluminio.



360°

SKYE

DARK GREY & LIGHT GREY



C67

C53



NOT AVAILABLE
IN SOME
EU COUNTRIES

SKYE

ART. 0404063N

COLORS

C53 C67

€ TBC
2 / 2 / 16

46,5 x 42 x H48/124 cm

108 x 60 x 11 cm

4,5 kg



360°

Sedia pieghevole a 4 gambe con schienale reclinabile a 6 posizioni.

CARATTERISTICHE:

- Struttura in alluminio
- Telo portante in Syntex Plus
- Schienale reclinabile a 6 posizioni
- Braccioli in resistente materiale plastico
- Possibilità di collegare un poggiatesta
- Compatta e comoda da trasportare quando ripiegata

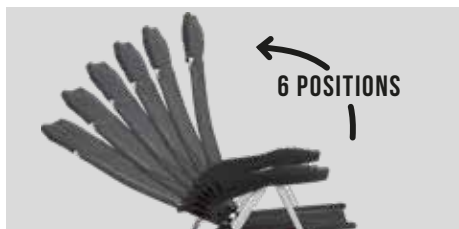

6 POSIZIONI

SWAN SKYE

ART. 0404067N.C67

€ TBC
1 / 1 / 12

90 x 69 x 113 cm

98 x 16 x 69 cm

7,5 kg

La sedia Swan Skye è la miglior prova che il campeggio può essere davvero confortevole. Essendo un vero e proprio prodotto outdoor la sua seduta permette di scegliere qualsiasi posizione rilassata si desidera.

CARATTERISTICHE GENERALI:

- Telaio in acciaio verniciato a polvere
- Telo portante in Syntex Plus
- Aperta e pronta all'uso in pochissimi secondi
- Facile da trasportare e compatta

OPTIONAL

SKYE FOOTREST

ART. 0404064N

COLORS

C53 C67

€ TBC
6 / 6 / 54

47 x 72 x H51/43 cm

47 x 72 x 6 cm

1 kg

Poggiatesta pieghevole.

CARATTERISTICHE:

- Struttura in alluminio
- Telo portante in Syntex Plus
- Compatto e comodo da trasportare quando ripiegato





C09

C06

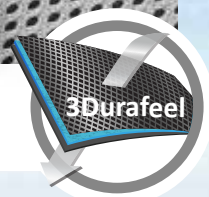

SKYE RT

ART. 0404060N

COLORS **C09** C06

€ TBC
2 / 2 / 16

43 x 49,5 x H47/120,5 cm

96 x 61 x 10 cm

5,5 kg

Sedia Camping pieghevole di alta qualità dotata di uno schienale alto regolabile a 7 posizioni ed una classica struttura ad U che garantisce un appoggio sicuro anche su pavimenti morbidi. Il telaio compatto e pieghevole è realizzato in tubolare di alluminio verniciato a polvere che, in combinazione con la resistente seduta in tessuto 3D, garantisce una seduta stabile e assai confortevole.

CARATTERISTICHE:

- Telaio pieghevole in alluminio verniciato a polvere
- Seduta in tessuto 3D Durafeel
- Schienale regolabile a 7 posizioni con poggiatesta integrato
- Eleganti braccioli in plastica resistente
- Elevato comfort di seduta
- Confezione molto compatta
- Poggiagambe fornibile come optional



OPTIONAL

SKYE UNIVERSAL FOOTREST

ART. 0404079N

COLORS **C09** C06

€ TBC
6 / 6 / 36

43 x 95 x H47/44 cm

43 x 95 x 7 cm

1,1 kg



Poggiagambe pieghevole universale per sedie Skye.

SKYE

BLACK & GREY



SKYE 3D

ART. 0404063N

€ TBC
2 / 2 / 16

🔒 47 x 41 x H47/122 cm
🔒 60,5 x 106,5 x 12 cm
📏 4,3 kg

COLORS C09 C06

SKYE 3D COMPACT

ART. 0404088N

€ TBC
4 / 4 / 20

🔒 65 x 57 x H40/95 cm
🔒 58 x 85 x 9 cm
📏 3,3 kg

COLORS C09 C06

Sedia da esterno pieghevole a 4 gambe con schienale reclinabile a 6 posizioni.

CARATTERISTICHE:

- Telaio in alluminio
- Tessuto 3D imbottito
- Schienale regolabile a 6 posizioni
- Braccioli in robusto materiale plastico
- Possibilità di collegare un poggiatesta
- Compatta e facile da trasportare quando ripiegata



Sedia pieghevole salvaspazio in alluminio con schienale fisso e struttura ad U. Schienale basso. Rivestimento in confortevole tessuto 3D.

OPTIONAL

STANDALONE FOOTREST

ART. 0404073N.C09

€ TBC
6 / 6 / 48



🔒 61 x 49 x H49 cm
🔒 67 x 60 x 8 cm
📏 2,1 kg



Poggiatesta autoportante a 4 gambe con copertura FULL-3D traspirante con telaio in alluminio verniciato a polvere.

SKYE 3D FOOTREST

ART. 0404064N.C09

€ TBC
6 / 6 / 54

🔒 47 x 72 x H51/43 cm
🔒 47 x 72 x 6 cm
📏 1 kg



Poggiatesta pieghevole per sedia Skye 3D.



PERFECT FOR VAN

COLLECTION



SANGRIA

ART. 0404082N

€ TBC
4 / 4 / 24

48 x 44 x H43/96 cm

70 x 58 x 8 cm

2,80 kg

Sedia outdoor ultracompatta e leggera. Con la sua struttura pieghevole a forma di U, questa sedia è perfetta per le vostre gite in campeggio. Con un peso di soli 2,8 kg, è facile da trasportare e piacevole da sedersi. È ideale per i campeggiatori, i proprietari di camper e tutti coloro che amano trascorrere del tempo all'aria aperta e che dispongono di uno spazio limitato per lo stivaggio.



COLORS

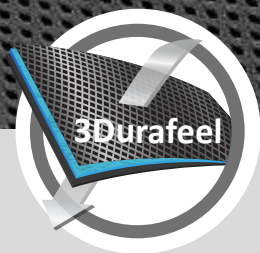

3DURAFEEL

Il tessuto di rivestimento 3Durafeel è un tessuto molto speciale utilizzato nelle nostre collezioni di sedie Aravel e Skye. Grazie alla sua permeabilità all'aria e alla delicatezza sulla pelle, trasforma il comfort in una meravigliosa esperienza di seduta per ore di relax all'aperto. 3Durafeel si asciuga incredibilmente in fretta anche dopo una leggera pioggia e irradia una piacevole atmosfera di benessere sulla veranda, sulla terrazza o sul balcone. E questo in modo affidabile per molti anni. Infatti, 3Durafeel è resistente allo strappo e all'abrasione, traspirante, resistente alla luce e repellente allo sporco. Costruzione a tre strati.



DYNAFOLD RECLINER

ART. 0404068N.C25

€ TBC
2 / 2 / 24

50 x 48 x H47/110 cm

94 x 22 x 24 cm

4,6 kg



La nostra sedia outdoor per eccellenza: leggera, resistente e confortevole. Con la sua robusta struttura in alluminio, questa sedia pieghevole compatta è perfetta per qualsiasi avventura. Tuttavia la struttura non è l'unico elemento che fa la differenza: il tessuto di rivestimento 3Durafeel aggiunge durata e comfort. E grazie allo schienale regolabile in 5 posizioni, potrete rilassarvi in tutta comodità ovunque andiate. Completo di sacca custodia.

VIVI LA TUA AVVENTURA SU QUATTRO RUOTE



Sedia da regista pieghevole con una robusta struttura in profilato quadrato ed elegante rivestimento in 3Durafeel. Progettata per garantire durata e stile, questa sedia è l'aggiunta perfetta a qualsiasi attrezzatura outdoor. Il robusto telaio assicura stabilità e sostegno, consentendo di rimanere seduti comodamente per periodi di tempo prolungati. Il rivestimento in 3Durafeel aggiunge un tocco di modernità al design classico della sedia da regista, offrendo al contempo una seduta confortevole. Questa sedia è costruita per durare e resistere all'uso frequente.

COMMANDER

ART. 0404080N

€ TBC
2 / 2 / 24

- 45 x 35 x 48/87,2 cm
- 73,5 x 51 x 13,5 cm
- 3,5 kg



COLORS

C06 C25

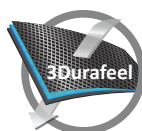

ARAVEL DIRECTOR

ART. 0404080N.C09

€ TBC
2 / 2 / 24

- 45 x 35 x 48/87,2 cm
- 73,5 x 51 x 13,5 cm
- 3,5 kg



ARAVEL VANCHAIR

ART. 0404077N.C09

€ TBC
2 / 2 / 32

- 48 x 37 x H41,5/82 cm
- 58,5 x 73,5 x 9,5 cm
- 3,8 kg

Sedia pieghevole super compatta con resistente telaio pieghevole in alluminio, appositamente realizzata per minibus e van. Snodo centrale in metallo. Rivestimento imbottito realizzato in comodo tessuto 3Durafeel per un alto livello di comfort.

Sedia da regista con telaio classico realizzato mediante profilo in alluminio verniciato a polvere. Ingombro ridotto grazie allo schienale ribaltabile. Seduta in tessuto 3Durafeel imbottito e traspirante. Braccioli imbottiti e rivestiti. Molto compatta e facile da riporre quando chiusa.

CARATTERISTICHE:

- Telaio salvaspazio in profilo di alluminio 22 x 22 mm
- Costruzione molto robusta
- Rivestimento realizzato in tessuto di poliestere 3Durafeel
- Schienale pieghevole per ridurre al minimo le dimensioni della confezione
- Braccioli imbottiti
- Elevato comfort di seduta
- Dimensioni di stivaggio ridotte

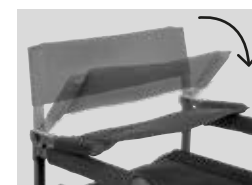



DIRECTOR CHAIR

COLLECTION



BRAVURA

ART. 0404190N

€ TBC
4 / 4 / 24

60 x 47 x H46/83 cm

11 x 49 x H83 cm

2,3 kg

COLORS



360°



SECURITY SYSTEM



Sedia regista con struttura pieghevole in alluminio. Schienale e seduta sono in poliestere antiscivolo. Seduta, schienale e braccioli sono imbottiti. Con meccanismo di chiusura di sicurezza.



ORBIT CHAIR L

ART. 0404010N.C20

€ TBC
6 / 6 / 150

55 x 42 x H40/75 cm

45 x Ø 10 cm

1,2 kg



Sedia Outdoor con innovativa struttura pieghevole che permette di ottenere delle dimensioni molto compatte e perfette per il trasporto. La combinazione ideale di comfort, peso leggero e montaggio semplice. Un vero e proprio must-have per backpackers, bikers, campers e in generale per qualsiasi attività all'aria aperta. Completa di pratica sacca custodia.





CAPTAIN

ART. 0404184N

€ TBC
4 / 4 / 32

- 48 x 46 x H45,5/81 cm
- 46 x 12 x H81 cm
- 2,8 kg



Sedia regista compatta con solida struttura in alluminio anodizzato.



ONE SHOT

ART. 0404164N.C20

€ TBC
4 / 4 / 24

- 56 x 45,5 x H46/81 cm
- 48 x 13,5 x H81 cm
- 2,15 kg



Sedia regista con struttura in alluminio.



RAPTOR

FOLDING CHAIR COLLECTION

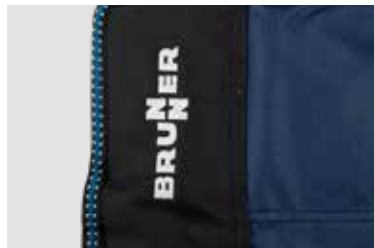

Comodi braccioli



Piedini girevoli



INFO

- Telaio in robusto acciaio verniciato
- Tessuto poliestere resistente alle intemperie
- Pieghevole e compatta
- Con porta bibite integrato (XL/Compact)
- Con sacca custodia



RAPTOR CLASSIC

ART. 0404040N

€ TBC
4 / 4 / 40

51 x 44 x H48/90 cm

94 x Ø 16 cm

4,6 kg

steel
Acciaio

100%
Polyester
2-tone

110kg

COLORS



Confortevole sedia pieghevole con sostegno laterale della seduta.



RAPTOR HIGHBACK

ART. 0404016N

€ TBC
4 / 4 / 24

COLORS C20 C55

🔒 51 x 44 x H48/110 cm

🔒 114 x Ø 16 cm

📏 6 kg

steel
Acciaio

100%
Polyester

🔒
120kg

Per offrire un comfort ancora maggiore pur mantenendo dimensioni di ingombro molto compatte, la Raptor, la nostra preferita di sempre tra le sedie pieghevoli, è stata dotata di uno schienale rialzato di circa 20 cm. L'uso di comodi braccioli in plastica robusta dà inoltre la sensazione di essere seduti su una classica sedia a 4 gambe. Tutte le altre caratteristiche di questa gamma di sedie sono state mantenute.

RAPTOR COMPACK

ART. 0404055N

€ TBC
4 / 4 / 32

COLORS C20 C55

🔒 61,5 x 60 x H46/90 cm

🔒 27 x 21 x H92 cm

📏 4,8 kg

steel
Acciaio

100%
Polyester

🔒
120kg



La nuova sedia Raptor Compack si caratterizza per la sua nuova struttura pieghevole che ne garantisce il minimo ingombro una volta chiusa e riposta, senza che ciò precluda l'abituale livello di confort delle sedie della collezione Raptor. Realizzata in acciaio verniciato a polvere e telo portante in robusto tessuto di poliestere spalmato. Completa di sacca per il trasporto.



BEST
SELLER



CRUISER

ART. 0404039N

€ TBC
4 / 4 / 32

COLORS C03 C30

🔒 51 x 44 x H48/90 cm

🔒 94 x Ø 16cm

📏 4,6 kg

steel
Acciaio

100%
Polyester

🔒
110kg

Confortevole sedia pieghevole con sostegno laterale della seduta. Grande stabilità grazie alla struttura in tubo ovale verniciata a polvere ed alle larghe basi regolabili dei piedi. Telo in robusto tessuto poliestere.



RAPTOR JACKOFALL

ART. 0404019N.C20

€ TBC
4 / 4 / -

🔒 65 x 60 x 90 cm

🔒 25 x 18 x 92 cm

📏 4,8 kg

steel
Acciaio

100%
Polyester

🔒
110kg



Raptor Jackofall è una sedia Outdoor versatile, progettata per offrire il massimo comfort e funzionalità. Il suo telaio pieghevole in acciaio offre una struttura robusta e durevole, mentre l'ampia imbottitura in tessuto di poliestere garantisce un elevato comfort di seduta. I braccioli multifunzionali, dotati di portabicchieri e portacellulare, garantiscono la massima comodità. Con il suo design professionale e funzionale, Raptor Jackofall è una compagna affidabile per le vostre esperienze all'aperto.



RAPTOR

FOLDING CHAIR COLLECTION



360°



VIDEO



RAPTOR NG 2.0

ART. 0404014N.C03

€ TBC
4 / 4 / 24

51 x 44 x H48/90 cm

94 x Ø 16 cm

4,8 kg



Sedia pieghevole molto confortevole con imbottitura 3D. Costruzione salvaspazio. Borsa da trasporto inclusa.

Sono stati apportati i seguenti miglioramenti alla versione aggiornata 2.0:

- Braccioli di nuova concezione con elegante e confortevole terminale in plastica
- Le aree laterali del rivestimento dello schienale sono completamente imbottite con tessuto 3D



RAPTOR 3D

ART. 0404034N.C03

€ TBC
4 / 4 / 32

51 x 44 x H48/90 cm

94 x Ø 16 cm

4,6 kg



Comoda e moderna: questa versione della sedia Raptor è dotata di un tessuto traspirante e ad asciugatura rapida. Mediante l'utilizzo della collaudata struttura Raptor rimane invariata l'eccellente stabilità di questo modello di sedia pieghevole.

OPTIONAL

ADJUSTABLE Ø 70-85MM



CANGAGE

ART. 0404023N

€ TBC
1 / 10 / -

15 x 22 x 7,5 cm

180 g

Il portabevande CANGAGE garantisce un supporto sicuro a lattine e bottiglie su moltissime sedie Outdoor, da campeggio e da giardino. Il sistema di montaggio rapido con regolazione angolare permette un posizionamento individuale del portabevande.



RAPTOR FOOTREST 3D

ART. 0404018N.C03

€ TBC
6 / 6 / 84

48 x 65 x H37 cm

65 x 18 x H11 cm

2,9 kg



Poggiagambe indipendente e autoportante con rivestimento in tessuto 3D. Ingombro ridotto grazie al pratico telaio pieghevole. Si adatta a tutte le sedie e poltroncine pieghevoli con rivestimento in tessuto 3D. Con sacca custodia.



RAPTOR XL

ART. 0404015N.C03

€ TBC
4 / 4 / 24

65 x 63 x H110 cm

114 x Ø 22 cm

6 kg



La nuovissima sedia pieghevole Raptor XL è il plus ultra per persone di statura superiore alla media. Naturalmente possiede tutti i vantaggi ed i miglioramenti dell'apprezzata serie di sedie pieghevoli Raptor.



LUMBAR SUPPORT



RAPTOR SUSPENSION

ART. 0404024N.C20

€ TBC
4 / 4 / 32

51 x 40 x H47/94 cm

110 x Ø 20 cm

4,95 kg



Comoda sedia pieghevole con schienale a sospensione elastica. Con borsa per il trasporto.



360°



360°



VIDEO



3 POSITIONS



RAPTOR RECLINER

ART. 0404050N.C20

€ TBC
2 / 2 / 24

51 x 45 x H45/102 cm

96 x Ø 25 cm

6,34 kg



Sedia pieghevole con schienale reclinabile a 3 posizioni. Con piedini antiscalfamento. Molto confortevole.



LOCK LEVER



CLOSED



KADRE

ART. 0406041N

€ TBC
5 / 5 / 200

40 x 35 x H29 cm

45 x 12 x H12 cm

1,20 kg



Tavolino di appoggio molto compatto con piano arrotolabile in alluminio verniciato. Telaio in acciaio pieghevole. Molteplici usi. Con borsa per il trasporto.





steel
Acciaio

102kg

100%
Polyester



ACTION EQUIFRAME

ART. 0404035N

€ TBC
6 / 6 / 60

50,5 x 57 x H46/77 cm

77 x 17 x H17 cm

2,75 kg

COLORS



Sedia pieghevole con speciale telaio brevettato che ne garantisce il non ribaltamento. Realizzata con telaio in acciaio verniciato e seduta in resistente tessuto di poliestere. Molto facile da aprire e chiudere. Completa di borsa per il trasporto.



REEL



ARMCHAIR EQUIFRAME

ART. 0404038N

€ TBC
6 / 6 / 36

85 x 60 x H46/91 cm

94 x 18 x H18 cm

3,35 kg

COLORS



Sedia pieghevole con ampi braccioli realizzata con speciale telaio brevettato che grazie alla sua conformazione ne impedisce il ribaltamento. Realizzata con struttura in acciaio verniciato e seduta in resistente tessuto di poliestere. Semplicissima da aprire e richiudere. Completa di sacca per il trasporto. Disponibile in 3 colori.

EQUIFRAME

HIGH STABILITY



ACTION KIDS EQUIFRAME

ART. 0404193N

€ TBC
6 / 6 / 72

62,5 x 42 x H31/64,5 cm

66 x 16 x H16 cm

2,39 kg

COLORS



ACTION BABY EQUIFRAME

ART. 0404191N.C73

€ TBC
1 / 1 / 18

49,5 x 67 x H58/94 cm

94 x 20 x H20 cm

4,7 kg



Sedia pieghevole per bambini con speciale telaio di sicurezza brevettato che grazie alla sua conformazione ne impedisce il ribaltamento. Realizzata con struttura autobloccante in acciaio verniciato e seduta in resistente tessuto di poliesteri. Semplicissima da aprire e richiudere. Completa di sacca per il trasporto. Disponibile in 3 colori vivaci ed attraenti.

Seggiolone salvaspazio da viaggio adatto per bambini dai 6 mesi fino a 4 anni (oppure 15 kg). Realizzato con speciale struttura di sicurezza in acciaio che grazie alla sua conformazione evita il ribaltamento del seggiolone stesso. La pratica seduta imbottita è facilmente lavabile e dispone di imbracatura regolabile con fissaggio a 3 punti. Completo di pratico vassoio.

CARATTERISTICHE:

- Braccioli imbottiti con bloccaggio di sicurezza
- Costruito e collaudato seconda la normativa EN16120
- Facile e veloce da ripiegare
- Telaio salvaspazio
- Imbracatura di sicurezza
- Con ampio vassoio per mangiare e bere
- Completo di sacca custodia



INFO

Sedia pieghevole con speciale telaio brevettato che ne garantisce il non ribaltamento.



ACTION VIVAVITA LOUNGER

ART. 0404036N

€ TBC

2 / 2 / 32

74 x 43 x H56/99 cm

118 x Ø 26 cm

4,05 kg



COLORS

C03

C06

Il Vivavita Lounger è una sedia pieghevole elegante e super confortevole, perfetta per outdoor, campeggio e giardino. Grazie al suo design semplice ma funzionale, si apre e si chiude senza sforzo in pochi secondi, senza bisogno di montaggio. Il telaio verniciato a polvere è dotato di una copertura in poliestere riccamente imbottita. Una borsa per il trasporto è inclusa nella fornitura.



ACTION

OUTDOOR LIFESTYLE



ACTION SOFA RENDEZ-VOUS

ART. 0404047N.C03

€ TBC
2 / 2 / 20

147 x 65 x H44/99 cm

31 x 20 x H101 cm

8,3 kg



Divano per 2 persone di nuova concezione, molto confortevole, con struttura pieghevole leggermente angolata. Ideale per rilassarsi nella zona soggiorno di tende o verande. Con area organizer centrale dotata di due tasche in tessuto a zanzariera. Sedile e schienale comodamente imbottiti. Apertura e chiusura in pochi secondi senza necessità di montaggio speciale. La fornitura comprende una borsa per il trasporto e lo stoccaggio.

ACTION SOFA 3D

ART. 0404041N.C09

€ TBC
2 / 2 / 20

148 x 63 x H44/92 cm

23 x 18 x H106 cm

5,2 kg



Confortevole divano con struttura pieghevole in acciaio.

CARATTERISTICHE:

- Tessuto poliestere 600D a doppio strato con inserti 3D
- Confortevoli braccioli con portabevande
- Design unico
- Con borsa di trasporto



360°

ACTION SOFA

ART. 0404041N

€ TBC
2 / 2 / 20

148 x 63 x H44/92 cm

23 x 18 x H106 cm

5,3 kg



COLORS

C03 C06



Divanetto con struttura pieghevole in metallo. Schienale in resistente tessuto imbottito.



360°



STOOLS

COLLECTION



NIRO

ART. 0404107N.C03

€ TBC
6 / 12 / 252

- 32 x 32 x H40 cm
- 58 x Ø 9 cm
- 450 g



Sgabello treppiede compatto. Borsa da trasporto inclusa.



BIG FJORD

ART. 0404103N

€ TBC
6 / 12 / 240

- 35 x 35 x H65 cm
- 76 x Ø 10 cm
- 800 g



Sgabello treppiede pieghevole con struttura in alluminio anodizzato Ø 19 mm.



JOLLY

ART. 0404105N

€ TBC
10 / 20 / 400

- 38 x 20,5 x H34 cm
- 23,5 x 28 x 2 cm
- 950 g



Sgabello pieghevole con solido telaio in filo di acciaio verniciato Ø 6 mm.



TWISTY SQUARE

ART. 0404116N

€ TBC
3 / 6 / 150

- 32 x 24 x H40 cm
- 32 x 45 x 5 cm
- 1,32 kg



TWISTY OVAL

ART. 0404117N

€ TBC
3 / 6 / 150

- 36 x 30 x H40 cm
- 36 x 45 x 5 cm
- 1,32 kg

Sgabello pieghevole di alta qualità con struttura in alluminio ed elegante seduta in bambù. Design robusto, affidabile ed elegante. Pronto all'uso in pochi secondi e molto comodo da trasportare quando non in uso a causa delle piccole dimensioni quando ripiegato. Utilizzo molto versatile. Con borsa custodia.

OUTDOOR COT

COLLECTION



OUTDOOR COT

ART. 0410032N.C30

€ TBC
2 / 2 / 38

190 x 64/72 x H43 cm

95 x 21 x H14 cm

4,8 kg



Letto da campo con struttura pieghevole e smontabile in alluminio.

OUTDOOR COT XL

ART. 0410045N

€ TBC
2 / 2 / 38

210 x 80 x H50 cm

103 x 20 x 12 cm

6,5 kg



Letto da campo di ampie dimensioni. Telaio in alluminio anodizzato.

OUTDOOR COT AUTOMATIC

ART. 0410044N

€ TBC
2 / 2 / 36

€ TBC
2 / 2 / 40

191 x 66 x H44 cm

105 x 15 x H15 cm

8,9 kg



Letto da campo robusto con struttura pieghevole appositamente progettata per essere aperta e ripiegata in un istante. Comoda tela in resistente tessuto di poliestere con poggiatesta integrato e imbottito. Di dimensioni compatte quando ripiegato. Con pratica borsa per il trasporto.

INFO

IL LETTINO DA CAMPO

I lettini da campo danno la possibilità di dormire in modo comodo e sicuro, ben rialzati dal terreno. Soprattutto in caso di maltempo si è protetti dal bagnato e dall'umidità. Inoltre non si è a contatto con fastidiosi insetti. A seconda del modello di lettino esiste la possibilità di stivare attrezzatura sotto al telo per dormire. Come per ogni acquisto di attrezzatura, sono molte le considerazioni da fare nella scelta di un lettino da campo. Ogni modello presente nel nostro catalogo ha dei vantaggi e svantaggi. E' soprattutto importante ragionare sul mezzo che verrà utilizzato per trasportare il lettino da campo: alcuni diventano molto piccoli perchè si possono scomporre o ripiegare, altri sono solo pieghevoli, con misure meno compatte, ma solitamente più confortevoli.



BEACH BED

COLLECTION



MALIBU'

ART. 0410011N

€ TBC

2 / 2 / 14

189 x 61 x H26 cm

79 x 61 x 16,5 cm

5,2 kg



COLORS

C06 C30

Letto da sole a tre gambe con pratico tettuccio parasole.

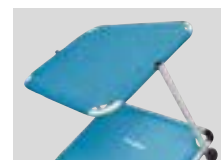

MALIBU' HIGH

ART. 0410010N

€ TBC

1 / 1 / -

189 x 61 x H48 cm

79 x 61 x 16,5 cm

6,1 kg



COLORS

C00 C06

Realizzato con una struttura in alluminio pieghevole, questo lettino prendisole a telo alto, offre un comfort ineguagliabile, sia che ci si crogioli a bordo piscina, che si passeggi sulla spiaggia o che ci si rilassi in giardino. Grazie al parasole incorporato, è possibile schermare gli occhi dal riverbero, assicurando un'esperienza serena e rigenerante.

CARATTERISTICHE:

- Superficie di appoggio alta
- Telaio pieghevole in alluminio
- Con parasole

INFO

SYNTEX PLUS

I tessuti Syntex vengono prodotti da fibre di poliestere rivestite in plastica. Grazie alla perfetta resistenza alle condizioni atmosferiche il tessuto Syntex è consigliato per le stoffe dei mobiletti da campeggio e da giardino.

MARBELLA

ART. 0410012N

€ TBC

2 / 2 / 12

 192 x 67 x H30 cm

 77 x 19 x H64,5 cm

 6,4 kg



COLORS



Letto da sole di alta qualità con struttura quadrangolare, a tre piedi ripiegabili in alluminio anodizzato. Tettuccio parasole regolabile.





MARBELLA HIGH

ART. 0410022N

€ TBC

1 / 1 / 9

 198 x 64 x H48 cm

 84 x 24 x H72 cm

 7,50 kg



COLORS



Letto da sole molto confortevole con struttura stabile e pieghevole a tre gambe in alluminio anodizzato, seduta molto alta (H=48 cm) realizzata in tessuto Syntex Plus resistente agli agenti atmosferici e schienale regolabile. La fornitura comprende un pratico tettuccio parasole.





BULA

BEACH CHAIRS



360°

Spiaggina pieghevole e compatta. Borsa da trasporto inclusa.



COLORS



BULA

ART. 0404148N

€ TBC
6 / 6 / 48

57 x 50 x H73,5 cm

68 x Ø 18 cm

3,1 kg

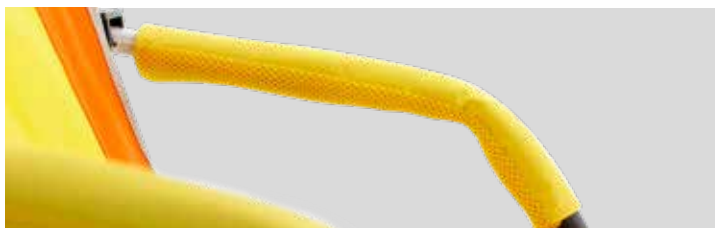

360°

Accomodarsi e rilassarsi - grazie alla sua speciale costruzione la spiaggia Bula XL raggiunge livelli altissimi in termini di comodità e relax.

CARATTERISTICHE:

- Seduta rialzata
- Alzarsi è più facile
- Seduta più larga
- Braccioli imbottiti
- Telaio pieghevole verniciato a polvere
- Piedini antispfondamento
- Tessuto in resistente poliestere
- Con borsa per il trasporto

BULA XL

ART. 0404149N

€ TBC
4 / 4 / 24

61 x 74 x H87/31 cm

98 x Ø 18 cm

4,7 kg

COLORS



CUBA

BEACH CHAIRS



CUBA HIGHBACK

ART. 0404146N

€ TBC
4 / 4 / -

59 x 76,5 x 24/85cm

77 x 13 x 19 cm

3,2 kg



Rilassatevi nel massimo comfort sulla sedia da spiaggia Cuba Highback, con schienale alto per un maggiore sostegno. Lo schienale ad asciugatura rapida vi garantisce di rimanere asciutti, mentre i braccioli imbottiti offrono un posto comodo per riposare. Scegliete tra due colori eleganti e godetevi la comodità del portabicchieri incorporato. Provate il perfetto equilibrio tra forma e funzione con questo pratico partner da spiaggia.

CARATTERISTICHE:

- Schienale alto per un maggiore comfort
- Schienale ad asciugatura rapida
- Con portabicchieri

MAKAI

ART. 0404154N

€ TBC
4 / 4 / -

64 x 63 x H28/90 cm

74 x 66 x H20 cm

4 kg



La spiaggia Makai offre un comfort e una versatilità eccezionali per le vostre avventure all'aperto. Dotata di tettuccio regolabile e rimovibile, la Makai offre un'ampia protezione dai raggi solari. La superficie di seduta estesa e l'ampio cuscino per la testa assicurano il massimo relax, mentre il rivestimento in Syntex di alta qualità conferisce una finitura elegante e resistente. Inoltre, le protezioni per le gambe proteggono dalle superfici ruvide, rendendo la Makai un compagno affidabile per le vostre giornate in spiaggia.

CARATTERISTICHE:

- Con tettuccio parasole regolabile e rimovibile
- Superficie di seduta estesa verso la parte posteriore per un maggiore comfort
- Ampio cuscino per la testa
- Rivestimento in tessuto di alta qualità
- Con protezioni per il telaio



SIREN

ART. 0404152N

€ TBC
4 / 4 / 24

64 x 63 x H28/82 cm

74 x 66 x H12 cm

3,6 kg



Sedia da spiaggia in alluminio con schienale reclinabile a 4 posizioni e cuscino per un maggior comfort. Leggera e facile da trasportare. Perfetta per rilassarsi e godersi il sole in piscina o in spiaggia.

CARATTERISTICHE:

- Schienale reclinabile in posizione completamente orizzontale
- Con gamba di supporto schienale pieghevole
- Confortevoli braccioli



CARGO

COLLECTION

<M>
mountless
the smart
folding system



CARGO LINX

ART. 0814011N

€ TBC

1/1/-

**NEW
2025**

100 x 53,5 x 102 cm

82 x 24 x 40 cm

12,3 kg

steel
Acciaio

100% Polyester

120kg

Cargo Linx è un carrello robusto e versatile, realizzato in acciaio di alta qualità. Grazie al suo telaio pieghevole, l'area di carico può essere riposta per risparmiare spazio quando non viene utilizzata. I materiali resistenti fanno del Linx un compagno affidabile per il trasporto di attrezzature e utensili.

CARATTERISTICHE:

- Sistema di ripiegamento monodimensionale
- Facile da riporre e trasportare
- Robusto telaio in metallo con verniciatura a polvere
- Tessuto in poliestere
- 2 portabicchieri



CARGO COMPACT

ART. 0814013N

€ TBC

1/1/20

**BEST
SELLER**

101 x 50 x H55 cm

33 x 20 x H73 cm

9 kg

steel
Acciaio

100% Polyester

68kg

Esecuzione come il modello Cargo, ma di dimensioni più compatte.



VIDEO



**MIX&
MATCH**



SKYE 3D
P. 151



SKYE 3D FOOTREST
P. 151



LINEAR
P. 188



POLARYS FREEZE DZ
P. 328

CARGO PRIME

ART. 0814017N

€ TBC
1/1/-



 123 x 55 x 112 cm

 80 x 55 x 30 cm

 14,2 kg



Il carrello pieghevole Prime è la soluzione ideale per trasportare senza fatica su superfici morbide e irregolari. Grazie ai pneumatici extra larghi e alle pareti laterali alte, questo carro resistente scivola facilmente su sabbia, erba e altri terreni difficili. Realizzato con materiali di alta qualità, tra cui un robusto telaio in acciaio e un tessuto in poliestere resistente all'acqua, il Prime Wagon è progettato per garantire longevità e affidabilità. La sua caratteristica principale è l'eccezionale distribuzione del peso garantita dai grandi pneumatici, che assicurano un'esperienza fluida e senza problemi quando si trasportano gli oggetti essenziali per la spiaggia, il materiale per il picnic, gli animali domestici e persino i bambini piccoli.

CARATTERISTICHE:

- Sistema di ripiegamento bidimensionale
- Facile da riporre e trasportare
- Robusta struttura in metallo con verniciatura a polvere
- Tessuto in poliestere con striscia riflettente
- Pareti laterali alte
- Grande volume di carico
- 2 portabicchieri
- Ruote staccabili
- Ruote anteriori con freno
- Ruote grandi adatte a terreni sabbiosi
- Anelli a D per il fissaggio del carico





BEACH CART NG





BEACH CART NG

ART. 0814001N.C57

€ TBC
5 / 5 / 30

 101 x 50 x H36 cm

 101 x 36 x H6 cm

 3,5 kg



Carrello multi-funzione pieghevole realizzato in acciaio verniciato a polveri. Ruote extra-larghe ed estraibili.









MINI ROLLY

ART. 0814007N

€ TBC
10 / 10 / 180

-  92 x 26 x 37 cm
-  45 x 26 x 10 cm
-  1,35 kg
-  30 kg





Carrello da trasporto con struttura telescopica in acciaio pieghevole e raccordi in resistente materiale plastico. Ruote larghe.



EASY

ART. 0814005N

€ TBC
6 / 6 / 72

-  46 x 35 x 99 cm
-  16 x 35 x 56 cm
-  3,3 kg
-  90 kg





Carrello pieghevole con robusta struttura in acciaio.



PICK UP

ART. 0814009N

€ TBC
6 / 6 / 96

-  32 x 28 x 87 cm
-  32 x 10 x 48,5 cm
-  1,9 kg
-  30 kg

Pratico trolley pieghevole con grandi ruote che rendono possibile l'utilizzo anche su terreni sterrati. Esecuzione leggera e stabile con profilo in acciaio verniciato a polvere. Cinghie di fissaggio incluse.





TABLE COLLECTION

SCEGLIAMO IL TAVOLO GIUSTO!



Un tavolo è in realtà non altro che un ripiano con quattro gambe: questo è il primo pensiero che viene in mente alla maggior parte delle persone prima di aver considerato seriamente l'acquisto di un tavolo outdoor.

Ma soprattutto, quando si parla di tavoli outdoor, un tavolo non è affatto un semplice tavolo. Numerose differenze sono da considerare: la funzione, il luogo di utilizzo, il sistema di montaggio e le dimensioni di trasporto.

Questo solleva automaticamente la domanda: quali tavoli Outdoor e Camping sono effettivamente disponibili sul mercato?

- Tavoli da campeggio e da esterno classici con piano fisso o pieghevole
- Tavoli da campeggio e da esterno ultraleggeri con piano fisso o pieghevole
- Tavoli da campeggio e da esterno pieghevoli con vassoio arrotolabile

Trovate ora il tavolo più adatto alle vostre necessità consultando la nostra vasta gamma di modelli con diverse funzioni, sistemi di montaggio, dimensioni di trasporto, colori e forme. Considerate le regole di base spiegate qui sopra, le proprie esigenze speciali ed il proprio stile preferito, vi rimane soltanto di tenere conto dell'ambiente circostante e delle condizioni di spazio preesistenti.



DINEMIC ELÙTOP

ART. 0406049N

€ TBC
1/1/-

126 x 70 x H56/85 cm

70 x 64 x 11 cm

6 kg

Dinemic Elùtop - il tavolo leggero perfetto per le vostre avventure all'aperto. Realizzato con una robusta struttura in alluminio e un leggero piano d'appoggio a nido d'ape, questo pezzo versatile offre una durata e una portabilità eccezionali. La struttura pieghevole consente di riporlo e trasportarlo facilmente, rendendolo un compagno ideale per il campeggio, i picnic o semplicemente per godersi la vita all'aria aperta. Grazie alle gambe regolabili, è possibile personalizzare l'altezza in base alle proprie esigenze, mentre la rete di contenimento e la borsa per il trasporto in dotazione offrono comode soluzioni di stoccaggio. Caratterizzato dal design "Classic Oak", questo tavolo unisce perfettamente stile e funzionalità.

CARATTERISTICHE:

- Struttura pieghevole
- Piano del tavolo realizzato con un pannello a nido d'ape ultraleggero
- Piano del tavolo con design "Classic Oak"
- 4 gambe regolabili in altezza
- Rete portaoggetti inclusa
- Incl. borsa per il trasporto



DINEMIC

ALUMINIUM TABLE TOP



DINEMIC 4

ART. 0406053N

€ TBC
1/1/15

126 x 70 x H56/85 cm

70 x 64 x 11 cm

8,2 kg

Il Dinemic è un tavolo per Outdoor e Camping di alta qualità con uno speciale piano pieghevole realizzato con doghe di alluminio particolarmente resistenti alle intemperie e all'usura. La struttura in metallo verniciato a polvere è dotata di gambe regolabili in altezza. Una volta ripiegato, può essere riposto in modo molto compatto ed è quindi ideale per minibus, furgoni e camper.

CARATTERISTICHE:

- Piano del tavolo resistente alle intemperie, adatto all'uso esterno
- Robusta struttura in metallo
- Regolazione continua delle gambe del tavolo
- Pieghevole al centro
- Leggero e facile da trasportare e riporre
- Completo di copertura di protezione

DINEMIC 6

ART. 0406045N

€ TBC
1/1/-

143 x 70 x 85 cm

149 x 14,5 x 32 cm

7,1 kg



<M>
mountless
the smart
folding system



Serratura di sicurezza



Pieghevole centralmente



Gambe quadrate



Gambe regolabili senza scatti



ACCELERATE CLASSIC

ROLLABLE TABLE TOP





ACCELERATE 4

ART. 0406091N

€ TBC

1 / 1 / 28

 120 x 80 x H71 cm

 124 x 18 x 18 cm

 7,3 kg

ACCELERATE 6

ART. 0406092N

€ TBC

1 / 1 / 20

 146,5 x 80 x H71 cm

 151 x 20,5 x 19 cm

 8,5 kg



La crescente popolarità del campeggio e del caravaning porta le comodità di tutti i giorni ad un livello completamente nuovo. Il tavolo Accelerate con ripiano arrotolabile è diventato uno dei tavoli da campeggio più leggeri, versatili e portatili sul mercato.

CARATTERISTICHE:

- Telaio in alluminio con tubo semiovale
- Ripiano arrotolabile con sistema Gapless
- Gambe pieghevoli
- Piedino regolabile
- Nuovo sistema di fissaggio del ripiano del tavolo
- Pratico ripiano in rete
- Borsa da trasporto inclusa



LOCKING SYSTEM



LEVEL SYSTEM



MAX
2 CM



OVAL LEGS



ACCELERATE COMPACK 4

ROLLABLE TABLE TOP

ACCELERATE COMPACK 4

ART. 0406093N

€ TBC

1 / 1 / 30

 120 x 80 x H71 cm

 80 x 21 x 23,5 cm

 7,3 kg



PATENTED

original design ➤

**PERFECT
FOR VAN**



OVAL LEGS

LOCKING SYSTEM

LEVEL SYSTEM

MAX
2 CM

L'Accelerate Compack 4 è l'ulteriore sviluppo del tavolo arrotolabile di successo Accelerate 4. Il design del telaio di nuova concezione consente di ridurre notevolmente le dimensioni del pacco, soddisfacendo così i requisiti di ingombro di minibus, van e camper furgonati.

CARATTERISTICHE:

- Adatto per max. 4 persone
- Telaio in alluminio con sistema a innesto
- Regolazione livello
- Piano d'appoggio in alluminio senza interruzioni
- Confezione molto compatta
- Con pratico ripiano in rete
- Con borsa di trasporto

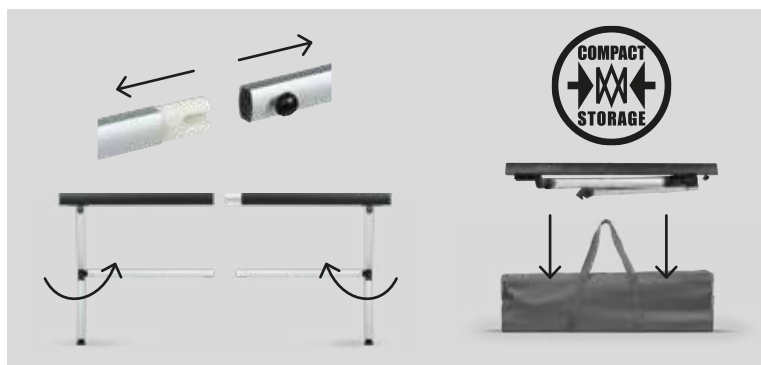



TITANIUM AXIA

ROLLABLE TABLE TOP



REEL



PATENTED



360°

TITANIUM AXIA 2

ART. 0406097N

€ TBC

1 / 1 / 32

104 x 62 x H72 cm

105 x 19 x 18 cm

5,5 kg



TITANIUM AXIA 4

ART. 0406098N

€ TBC

1 / 1 / 32

122 x 76 x H72 cm

122 x 18 x 17 cm

7,1 kg



TITANIUM AXIA 6

ART. 0406099N

€ TBC

1 / 1 / 20

147 x 76 x H72 cm

147 x 18 x 20 cm

8,2 kg



Tavolo in alluminio brevettato con ripiano arrotolabile e speciale telaio pieghevole di facile montaggio.

CARATTERISTICHE:

- Piano arrotolabile con listelli anodizzati color argento (sistema Gapless)
- Con livella a bolla integrata
- Telaio molto stabile realizzato con tubi quadrati in alluminio e barra stabilizzatrice centrale
- Piedino regolabile
- Con comoda rete e borsa da trasporto con due scomparti separati



LOCKING SYSTEM



LEVEL SYSTEM



MAX
2 CM



SQUARE LEGS

TITANIUM QUADRA TROPIC

ROLLABLE TABLE TOP



La versione elegante del Titanium Quadra NG. Ripiano in alluminio con listelli terminali in vero legno di bambù e livella a bolla d'aria integrata per il perfetto funzionamento del nuovo sistema di livellamento 90° Adjustar. Con borsa da trasporto.

PATENTED

4X

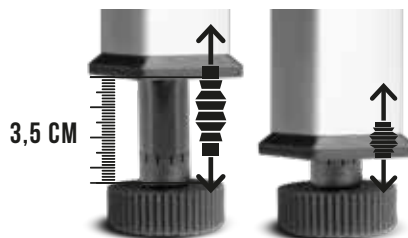

QUADRA TROPIC 4

ART. 0406095N

€ TBC
1/1/25

120,5 x 70 x H72 cm

122 x 17,5 x 24,5 cm

7 kg



REEL



360°

QUADRA TROPIC 6

ART. 0406096N

€ TBC
1/1/20

146 x 70 x H72,5 cm

149 x 32 x 14,5 cm

8,3 kg



Adjustar è un sistema di livellamento brevettato che permette una regolazione molto semplice dell'altezza delle gambe di appoggio mediante un nuovo metodo meccanico di trasmissione della spinta.

Grazie a questo meccanismo è possibile evitare che i mobili pendano in una direzione. Ogni camperista conosce questo problema e quanto sia laborioso e noioso regolare le gambe dei tavoli che devono essere spostati in alto, in basso e lateralmente, soprattutto quando ci si trova su terreni irregolari.

Ma Adjustar può essere utilizzato anche su terreni pianeggianti. Soprattutto se utilizzati negli spazi esterni, sui piani dei tavoli si formano piccole pozzanghere, che in combinazione con impurità come il polline, per fare un esempio, danno luogo a sgradevoli sbavature. Grazie al sistema Adjustar è possibile inclinare i tavoli per far defluire l'acqua.



TITANIUM QUADRA NG

ROLLABLE TABLE TOP



La nuova gamma di tavoli Quadra in alluminio con piano arrotolabile è caratterizzata da un nuovissimo telaio pieghevole, basato sulla classica costruzione del tavolo a 4 gambe verticali. Il piano del tavolo cosiddetto Gapless poiché senza intercapedini, è collegato al telaio del tavolo con uno speciale meccanismo di bloccaggio rapido. A differenza dei classici tavoli pieghevoli con telaio a X, il Quadra offre spazio sufficiente per le gambe su tutti e 4 i lati. Installazione facile e veloce. Design moderno combinato con una funzionalità migliorata. Una borsa custodia per il trasporto.

TITANIUM QUADRA 4 NG

ART. 0406054N

€ TBC
1/1/20

120,5 x 70 x H72 cm

122 x 17,5 x 24,5 cm

6,3 kg



LOCKING SYSTEM



LEVEL SYSTEM



MAX
2 CM



TITANIUM QUADRA 6 NG

ART. 0406065N

€ TBC
1/1/17

146 x 70 x H72,5 cm

149 x 32 x 14,5 cm

7,5 kg

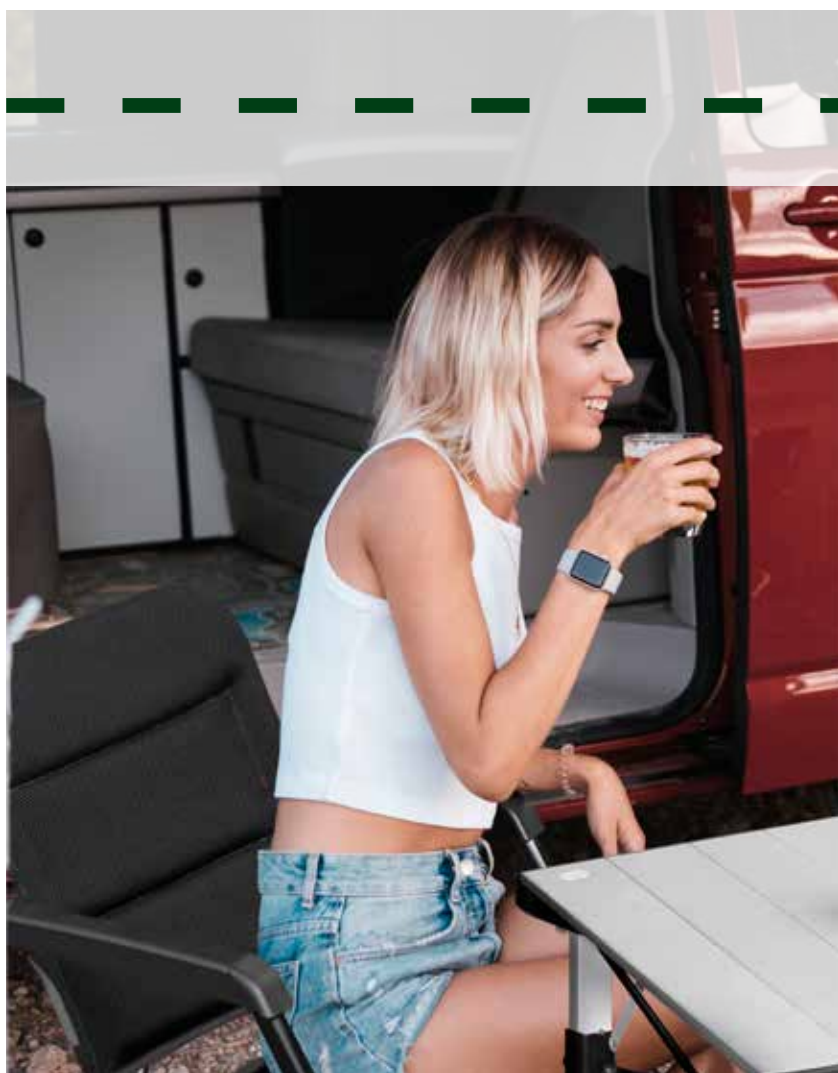

TITANIUM QUADRA 4 COMPACK

ROLLABLE TABLE TOP





TITANIUM QUADRA COMPACK 4

ART. 0406056N

€ TBC
1 / 1 / 30

 120,5 x 70 x H72 cm

 85 x 22 x 23,5 cm

 6,3 kg



originaldesign 



PERFECT
FOR VAN



Il tavolo con piano arrotolabile Quadra Compack 4 si distingue per la struttura del telaio divisibile di nuova concezione, che consente di ridurre notevolmente le dimensioni dell'imballaggio e si adatta quindi alle particolari esigenze di spazio di minibus, van e camper furgonati. Rispetto al Quadra Classic, la stabilità, la funzionalità e l'aspetto rimangono invariati.

CARATTERISTICHE:

- Adatto per un massimo di 4 persone
- Telaio in alluminio con sistema a innesto
- Regolazione livello
- Piano del tavolo in alluminio senza fessure (Gapless)
- Confezione molto compatta
- Con sacchetto di imballaggio

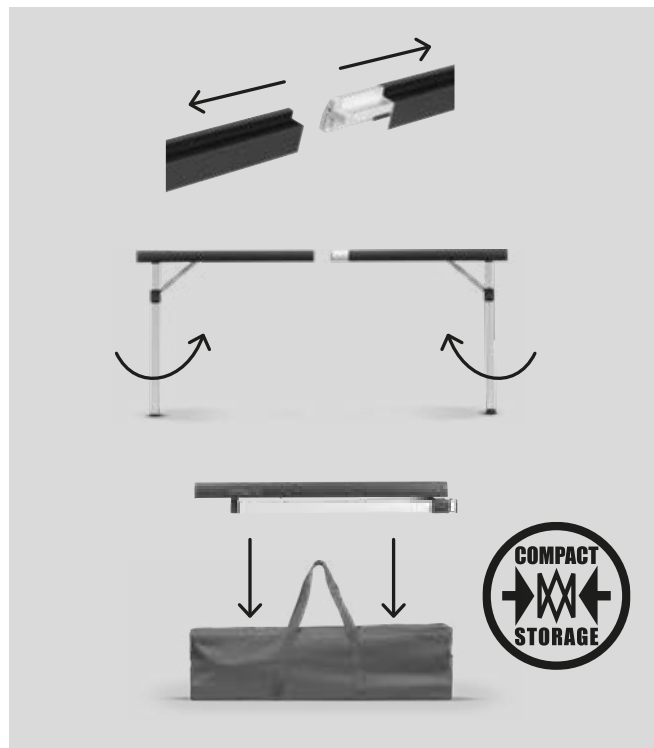



SPACE SAVER 8 CM

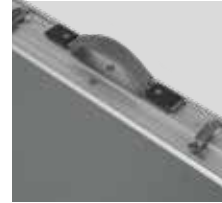

FLATPACK 4

ART. 0406105N

€ TBC
1 / 1 / 24

CARATTERISTICHE:

- Ripiano resistente alle intemperie, adatto per l'uso esterno
- Stabile struttura in profilo rettangolare di alluminio
- Regolabile in altezza senza scatti
- Ripiano pieghevole a metà
- Leggero e facile da trasportare quando ripiegato

120 x 60 x H70 cm

60 x 60 x 8 cm

6,5 kg



HOGGY FIX

ART. 0406052N

€ TBC
10 / 10 / 120

40 x 40 cm

1,1 kg



Piano per sgabelli con superficie laminata resistente ai graffi.

TOP FOR STOOL
STOOL NOT INCLUDED



HOGGY SET

ART. 0406051N.C03

€ TBC
6 / 6 / 36

40 x 40 x H43 cm

55 x 40 x 7,4 cm

1,6 kg



Pratico set composto da un leggero sgabello pieghevole in alluminio con seduta in poliestere e robusto piano del tavolo. Viene fornito con borsa di trasporto.



SILVER GAPLESS

ROLLABLE TABLE TOP





SILVER GAPLESS LEVEL 4

ART. 0406076N

€ TBC

1 / 1 / 30

 110 x 71 x H70 cm

 107 x 18 x H20 cm

 7,1 kg





SILVER GAPLESS LEVEL 6

ART. 0406077N

€ TBC

1 / 1 / 21

 140 x 81 x H70 cm

 124 x 22 x H22 cm

 9 kg



LEVEL SYSTEM



Tavolo pieghevole in alluminio con ripiano arrotolabile. Grazie alla speciale livella a bolla integrata, è possibile ottenere un posizionamento assolutamente orizzontale del ripiano su terreni irregolari (Level System). Struttura stabile con una gamba regolabile in altezza. È inclusa una borsa per il trasporto.



TORUN



TORUN 2

ART. 0406101N

€ TBC

2 / 4 / 32

80 x 60 x H71 cm

80 x 60 x 5 cm

4,2 kg



SPACE SAVER
5 CM



TORUN 4

ART. 0406102N

€ TBC

2 / 4 / 24

110 x 61,5 x H71 cm

110 x 61,5 x 5 cm

5,1 kg

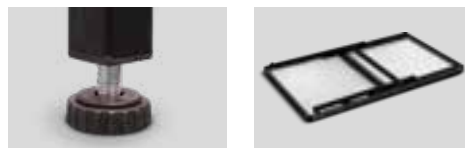

Nuova serie di tavoli con ripiano in alluminio e gambe pieghevoli in acciaio verniciato. Compatti e facili da trasportare. L'impiego di materiali di alta qualità garantisce un utilizzo duraturo nel tempo.

<M>
mountless
the smart
folding system



CLUB

BLOW-MOLDED TABLE TOP



CLUB 120

ART. 0406018N

120 x 59 x H74 cm

60 x 59 x H9 cm

10 kg

€ TBC
1 / 1 / 22



CLUB 150

ART. 0406010N

152 x 71 x H74 cm

76 x 71 x H9 cm

12 kg

€ TBC
1 / 1 / 22



Tavolo pieghevole Club

CARATTERISTICHE:

- Sistema bloccagambe di sicurezza
- Piedi regolabili in altezza
- Molto piatti quando ripiegati - facile da riporre
- Ripiano in plastica PE soffiato
- Gambe tavolo in acciaio verniciato a polvere, effetto martellato
- Lunga durata

<M>
mountless
the smart
folding system

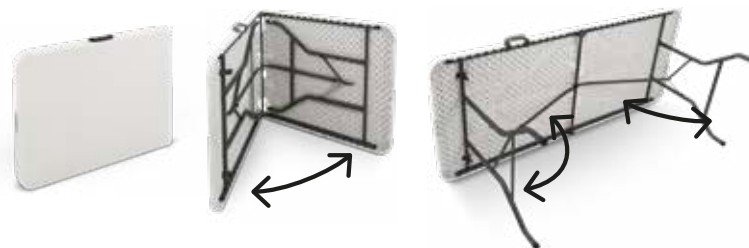



CAMPERKING

BAMBOO



CAMPERKING S

ART. 0406089N

€ TBC
1 / 1 / 30

Tavolo Outdoor con struttura in metallo e ripiano in bambù.

CARATTERISTICHE:

- Struttura pieghevole (sistema Mountless) in profilato di alluminio
- Ripiano in resistente bambù per esterni
- Piedino regolabile di livellamento
- Molto compatto e facile da riporre quando ripiegato
- Ottima stabilità
- Con pratica maniglia per il trasporto

 80 x 60 x H49/58/70 cm

 82,5 x 63 x 7 cm

 7 kg

CAMPERKING M

ART. 0406090N

€ TBC
1 / 1 / 30

 100 x 72 x H49/58/70 cm

 102 x 39 x 10 cm

 8,6 kg

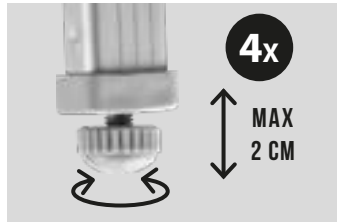

<M>
mountless
the smart
folding system

RECTANGULAR LEGS



CAMPERKING R

BAMBOO



4-FOLD TABLE TOP

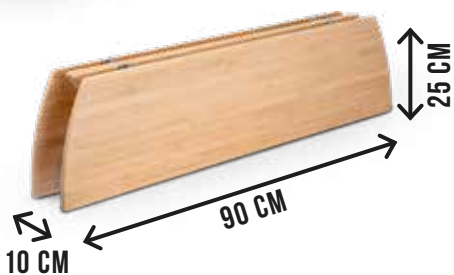
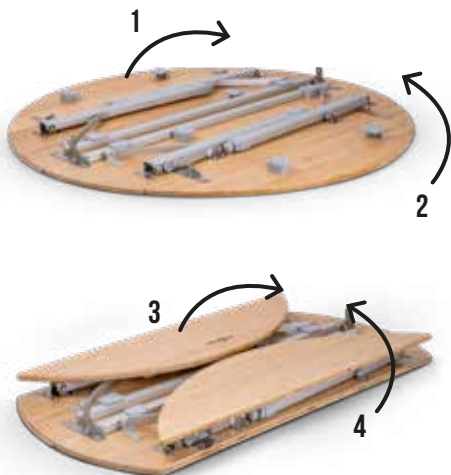

CAMPERKING R

ART. 0406084N

€ TBC
1 / 1/20

🔒 Ø 90 x H49/58/70 cm

🔒 90 x 10 x H25 cm

📦 7,9 kg

Tavolo rotondo per camping e outdoor con piano pieghevole a 4 elementi realizzato in elegante legno di bambù e struttura in alluminio regolabile in altezza. Dimensioni di ingombro molto compatte.

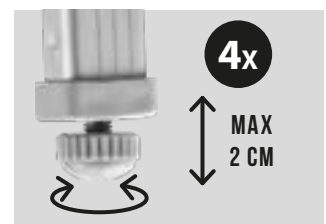

TABLETOP IS WEATHER RESISTANT FOR SHORT PERIODS





LINEAR

BLACK



TELESCOPIC
H 63/83 CM



SPACE SAVER



<M>
mountless
the smart
folding system



Dispositivo di bloccaggio gambe tavolo



SMARTLOCK

Gambe regolabili senza scatti



1,6 CM

3 CM

Bordo del tavolo in materiale plastico
Ripiano resistente alle intemperie



-40° / +40°

Piedino di livellamento con snodo



LINEAR 80

ART. 0406036N.C69

€ TBC
1 / 1 / 17

80 x 60 x H63/83 cm

80 x 60 x 7 cm

6,9 kg



I modelli di tavolo della serie Linear sono dotati di ripiani di alta qualità resistenti alle intemperie ed al calore.

CARATTERISTICHE:

- Altezza regolabile senza scatti
- Gambe tavolo telescopiche verniciate a polvere
- Ripiano di qualità resistente alle intemperie ed al calore (180°C)
- Facile da pulire

LINEAR 100

ART. 0406039N.C69

€ TBC
1 / 1 / 12

100 x 68 x H63/83 cm

100 x 68 x 7 cm

8,5 kg

**LINEAR 115**

ART. 0406031N.C69

€ TBC
1 / 1 / 14

115 x 70 x H63/83 cm

115 x 70 x 8 cm

12,7 kg

**DRINKMASTER S**

ART. 0404029N.C9N

€ TBC

20 / 80 / 1280

20 x 10 cm

170 g

Pratico supporto portabevande realizzato in materiale plastico di ottima qualità. Costruito come un morsetto gigante, il Drinkmaster può essere fissato rapidamente a qualsiasi tavolo o a qualsiasi supporto piano. Le 2 pinze rivestite di materiale antisdruciuolo garantiscono un'ottima presa su quasi tutte le superfici.

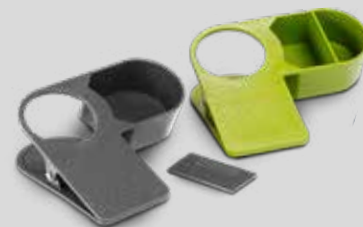
**DRINKMASTER**

ART. 0404061N.C9N

€ TBC

12 / 24 / 528

20 x 18 cm

226 g

Drinkmaster - il portabevande intelligente per il campeggio, il camper, il caravan, la nautica ed il giardino. Viene agganciato lateralmente al tavolo e garantisce un appoggio sicuro a bicchieri, lattine e svariati piccoli accessori.

originaldesign



RECREO

GREY



PATENTED



<M>
mountless
the smart
folding system



RECREO 80

ART. 0406110N

€ TBC
1 / 1 / 29

80 x 60 x H70 cm

80 x 60 x 7 cm

5,9 kg



PATENTED

RECREO 100

ART. 0406111N

€ TBC
1 / 1 / 23

100 x 68 x H70 cm

100 x 68 x 7 cm

6,1 kg

Il tavolo Recreo per Outdoor e Camping si distingue per la sua eccezionale stabilità e qualità e per il suo design innovativo ed elegante. Dotato di una speciale struttura in alluminio con guida centrale brevettata e di un solido ripiano Sevelit, conosciuto in tutto il mondo per la sua resistenza agli agenti atmosferici ed alle sollecitazioni meccaniche. L'utilizzo di raccordi e giunti in materiale plastico di alta qualità abbinato ad un processo di produzione professionale ha creato un modello di tavolo ideale per affrontare la vita all'aperto per molti anni. Disponibile in 2 misure.

CARATTERISTICHE:

- Uso versatile, indoor/outdoor
- Alta resistenza ai raggi UV, alle intemperie ed al calore (pentole, sigarette)
- Ripiano Sevelit con bordo di protezione perimetrale
- Eccezionale resistenza ai graffi ed alle sollecitazioni meccaniche
- Facile da pulire
- Montaggio semplice e rapido
- Regolabile in altezza senza scatti

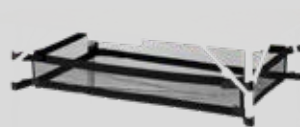

STORACK 80

ART. 0406121N

€ TBC
4 / 20 / -

80 x 60 x H13 cm

100% Polyester

STORACK 100

ART. 0406122N

€ TBC
4 / 20 / -

100 x 72 x H13 cm

100% Polyester

Pratico ripiano supplementare in rete per tavoli a 4 gambe verticali. Costruzione regolabile in lunghezza. Facilissimo da applicare mediante cinghiette munite di nastro Velcro. Completo di sacchetto custodia. Disponibile in 2 misure.

AMULET

GRANITE



PATENTED



NEW
2025



1X



1X

AMULET 100

ART. 0406025N

€ TBC
1/1/-

- 100 x 68 x H50,5/75 cm
- 100 x 68 x 11 cm
- 7,40 kg

AMULET 120

ART. 0406027N

€ TBC
1/1/-

- 120 x 68 x H50,5/75 cm
- 120 x 68 x 11 cm
- 8,40 kg

Progettato per la versatilità e la facilità di installazione, Amulet è dotato di gambe regolabili in altezza e di un sistema di livellamento "Adjustar" applicato ad una gamba, garantendo una superficie stabile e piana anche su terreni irregolari. Realizzato con un piano in Severin ultraleggero, il tavolo offre un look moderno ed elegante che si adatta a qualsiasi ambiente esterno. Per aggiungere praticità, il tavolo è dotato di una pratica rete di contenimento e di una borsa per il trasporto e la conservazione.

CARATTERISTICHE:

- Con sistema di telaio brevettato
- Tutte le 4 gambe sono regolabili in altezza
- Con sistema di livellamento "Adjustar" su una gamba
- Piano del tavolo realizzato con pannello Severin ultraleggero
- Design moderno
- Rete portaoggetti inclusa
- Incl. borsa per il trasporto



INFO ADJUSTAR LEVELLING SYSTEM



VIDEO

INFO P. 179



PATENTED





ELÙ

GREYWOOD



alu **30kg** **PATENTED** **ultralight**

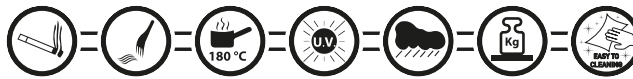

Tavolo per Outdoor e Camping di qualità superiore con meccanismo pieghevole esclusivo di nuova concezione e piano del tavolo ultraleggero a nido d'ape. Il bordo del tavolo, che si estende su tutto il perimetro, garantisce maggiore stabilità e sicurezza. Grazie a una guida centrale, il tavolo può essere montato e smontato in pochi secondi senza problemi.

CARATTERISTICHE:

- Piano del tavolo: struttura ultraleggera, resistente alle intemperie e al calore - design in legno grigio
- Telaio: in alluminio con esclusivo meccanismo di ripiegamento delle gambe del tavolo
- Gambe del tavolo: alluminio anodizzato nero ø 28/25 mm, con regolazione precisa dell'altezza
- Con pratico ripiano in rete

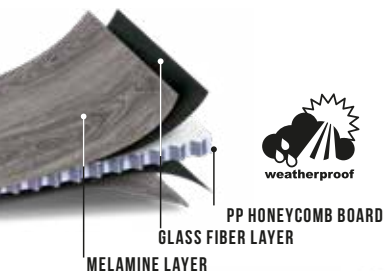

<M>
mountless
the smart
folding system



ELÙ NG 100

ART. 0406040N

€ TBC
1/1/-

- 100 x 70 x H50,5/70 cm
- 100 x 70 x 11 cm
- 4,6 kg

ELÙ NG 120

ART. 0406043N

€ TBC
1/1/-

- 120 x 80 x H50,5/70 cm
- 120 x 80 x 11 cm
- 5,6 kg



ELÙ DUPLIT NG

ART. 0406061N

€ TBC
1/1/-

- 110 x 75 x H49/58/70 cm
- 110 x 37,5 x 9 cm
- 4,9 kg



ultralight



Tavolo molto robusto e ultraleggero con piano pieghevole al centro e struttura funzionale in alluminio. Grazie allo speciale design, il piano del tavolo, regolabile in altezza e salvaspazio, può essere ripiegato sul lato inferiore del tavolo e aumenta lo spazio per le gambe su tutti e 4 i lati. Il piano del tavolo multistrato dal design esclusi e resistente alle intemperie ha una speciale struttura a nido d'ape con bordo rinforzato. Può essere ripiegato in modo molto compatto e riposto. Con maniglia per il trasporto.

CARATTERISTICHE:

- Bordo circolare con angoli arrotondati e profilo di copertura grigio
- Esclusivo ripiano tavolo Greywood
- Nuovi profili delle gambe del tavolo con regolazione di precisione



ELÙTOP COMPACK 80

ART. 0406057N

€ TBC
1/1/24

- 80 x 80 x H43,5/70,5 cm
- 80 x 40 x 11 cm
- 6,7 kg

ELÙTOP COMPACK 120

ART. 0406059N

€ TBC
1/1/-

- 120 x 60 x H41,5/70,5 cm
- 64 x 66 x 12 cm
- 7,5 kg



Gli Elùtop ComPack sono tavoli outdoor di alta qualità con un piano pieghevole ultraleggero e una comoda funzione di regolazione dell'altezza. Sia che stiate facendo campeggio, escursioni o picnic, questi tavoli renderanno la vostra esperienza più comoda e conveniente. Il design robusto e durevole garantisce una lunga durata, mentre la funzione di ripiegamento facilita lo stoccaggio e il trasporto.

ELÙTOP COMPACK EXTENSION

ART. 0406060N

€ TBC
1/1/-

- 116/155 x 78 x 80 cm
- 83 x 17,5 x 65cm
- 6,5 kg



Il tavolo allungabile Elutop Compack è una soluzione polivalente e salvaspazio per le vostre esigenze di ristorazione all'aperto. Caratterizzato da un elegante piano ultraleggero a nido d'ape e da un design classico in rovere, questo tavolo unisce senza sforzo stile e funzionalità. Il piano allungabile consente di regolare le dimensioni per accogliere più ospiti, mentre il piano d'appoggio può essere utilizzato come comodo tavolino. La struttura pieghevole e la borsa per il trasporto in dotazione lo rendono facile da trasportare e riporre quando non viene utilizzato. Con quattro gambe regolabili in altezza e una pratica rete per riporlo, questo tavolo da esterno è il compagno perfetto per il giardino, il patio o il campeggio.



AZABACHE

SQUARE



360°

AZABACHE LS

ART. 0422081N.C03

€ TBC
1 / 1 / 30

59 x 48 x H104 cm

42 x 11 x 53 cm

5,2 kg

Armadio funzionale in alluminio con ripiani interni.

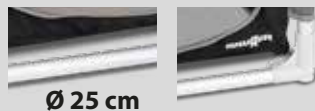

Ø 25 cm



AZABACHE HS

ART. 0422082N.C03

€ TBC
1 / 1 / 25

59 x 48 x H140 cm

42 x 11 x 69 cm

6,3 kg

Armadio funzionale in alluminio grande con ripiani interni.

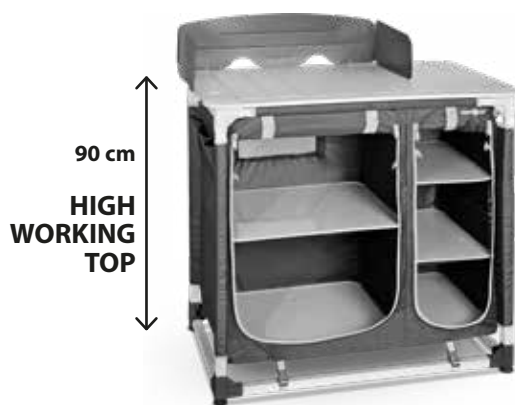

90 cm

HIGH
WORKING
TOP



AZABACHE CT SQUARE

ART. 0422085N.C03

€ TBC
1 / 1 / 18

85 x 52 x H90 cm

86 x 14 x 49 cm

9 kg

Mobiletto cucina di nuova concezione con 2 scomparti multifunzionali separati. Piano di lavoro arrotolabile alto in alluminio.

CARATTERISTICHE:

- Telaio quadrato di nuova concezione per una maggiore stabilità
- Gambe regolabili in altezza per adattarsi a terreni irregolari
- Rivestimento in poliestere resistente
- Zanzariera di aerazione nella parete posteriore
- Completo di paravento
- Con sacca custodia

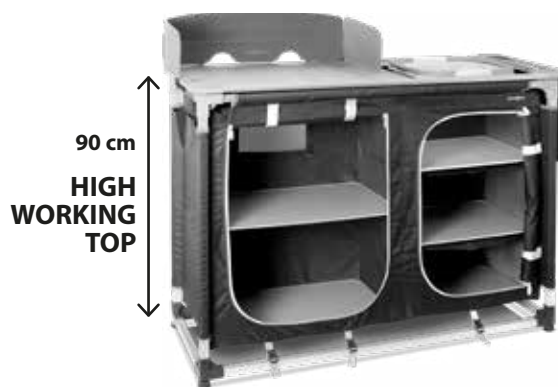

90 cm

HIGH
WORKING
TOP

AZABACHE CTW SQUARE HWT

ART. 0422086N.C03

€ TBC
1 / 1 / 15

110 x 48 x H90/118 cm

120 x 49 x 15 cm

11 kg

Pratica cucina da campeggio con lavello pieghevole integrato e rimovibile e 2 grandi vani portaoggetti con tanto spazio per il cibo e gli utensili da cucina. Con piano arrotolabile in alluminio di grandi dimensioni e gambe regolabili in altezza. Struttura estremamente stabile grazie all'impiego di profili rettangolari resistenti alla torsione. Montaggio semplice e veloce. Altezza di lavoro: 90 cm. La fornitura include un paravento ed un paraspruzzi, oltre ad una pratica borsa per il trasporto.

CARATTERISTICHE:

- Struttura in alluminio
- Tessuto: 100% poliestere spalmato
- Scomparti: 2 vani portaoggetti separati con cerniera (5 ripiani)



INCLUDED
INFO P. 312
CLEO
FOLD-AWAY

AZABACHE

CROSS SQUARE



AZABACHE HSC CROSS SQUARE

ART. 0422090N.C03

€ TBC
1/1/12

 70 x 59 x H125 cm

 72 x 17 x 92 cm

 8 kg



Grande armadio multifunzionale con 2 scomparti separati con cerniera e 6 ripiani interni. Lo scomparto più stretto può essere trasformato in armadio grazie ai ripiani divisibili e alla barra pensile integrata. Struttura molto robusta con telaio trasversale in alluminio e profili rettangolari resistenti alla torsione. Le pareti anteriori e posteriori possono essere ulteriormente stabilizzate tramite uno speciale dispositivo di tensionamento. I piedini di appoggio impediscono che l'armadio sprofondi in un terreno soffice o rovini il pavimento della tenda o la moquette. Il piedino regolabile in altezza consente una perfetta compensazione del livello su terreni irregolari. Una finestra in zanzariera nella parete posteriore fornisce la ventilazione interna all'armadio.

CARATTERISTICHE:

- Struttura: Alluminio
- Tessuto: 100% poliestere spalmato
- Con borsa

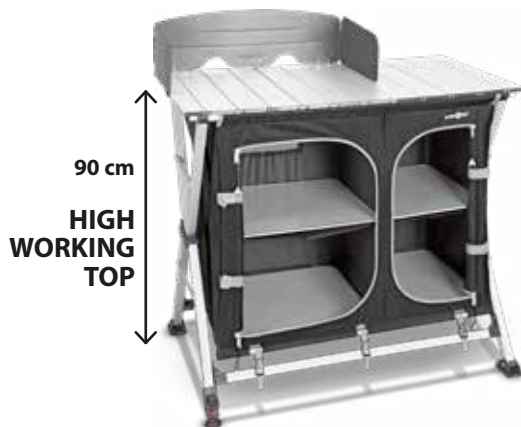

90 cm

HIGH
WORKING
TOP

AZABACHE CT CROSS SQUARE

ART. 0422088N.C03

€ TBC
1/1/12

 99 x 51 x H90/115 cm

 102 x 13 x 59 cm

 8,9 kg

Armadio multifunzionale di nuova concezione con struttura CROSS in tubolare di alluminio. 1 piedino regolabile in altezza, orientabili e di dimensioni tali da evitare l'affondamento in terreni morbidi. Dotato di 2 scomparti separati e ripiano di lavoro in alluminio resistente (sistema Gapless) con livella integrata.

CARATTERISTICHE:

- Telaio quadrato di nuova concezione per una maggiore stabilità
- Piano di lavoro alto
- Rivestimento in poliestere resistente
- Zanzariera di aerazione nella parete posteriore
- Completo di paravento
- Con sacca custodia

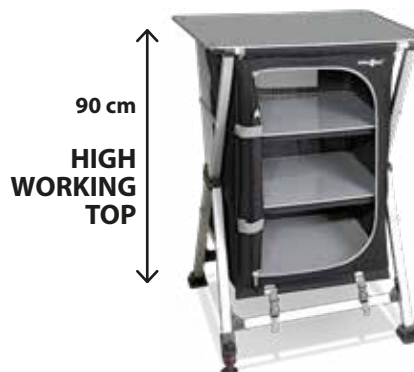

90 cm

HIGH
WORKING
TOP

AZABACHE LS CROSS SQUARE

ART. 0422089N.C03

€ TBC
1/1/18

 58 x 49 x H90 cm

 62 x 12 x 61 cm

 7,3 kg

Armadio multifunzionale di nuova concezione con struttura CROSS in tubolare di alluminio. 1 piedino regolabile in altezza, orientabili e di dimensioni tali da evitare l'affondamento in terreni morbidi. Dotato di grande scomparto e ripiano di lavoro in MDF rinforzato.

CARATTERISTICHE:

- Telaio quadrato di nuova concezione per una maggiore stabilità
- Rivestimento in poliestere resistente
- Zanzariera di aerazione nella parete posteriore
- Con sacca custodia

<M>
mountless
the smart
folding system



360°



VIDEO

<M>
mountless
the smart
folding system



REEL



AZABACHE

DAILY

AZABACHE DAILY CT

ART. 0422084N.C06

€ TBC
1 / 1 / 13



VIDEO

<M>
mountless
the smart
folding system



102 x 50,5 x H84 cm

105 x 53 x 9 cm

9,3 kg



Mobiletto box di alta qualità con robusto telaio pieghevole in profilato di alluminio.

CARATTERISTICHE:

- Zanzariera di aerazione nella parete posteriore
- Piedini regolabili in altezza
- Con maniglia per il trasporto
- Con sacca custodia



WINWALL

ART. 0426D11N

€ TBC
5 / 10 / 150

63,5 x 31 x H25,5 cm

63,5 x 31 x H1 cm

2,20 kg



Paravento per piano cottura con base resistente al calore. Tutti gli elementi sono pieghevoli e realizzati in metallo verniciato a polveri. Per fornelli a 2 e 3 fuochi.



AZABACHE CUBE

ART. 0422091N.C06

€ TBC
1 / 1 / 16

65 x 45 x H58/81 cm

65 x 15 x H45 cm

9,7 kg



Mobiletto cucina pieghevole portatile con nuovissima struttura salvaspazio Mountless in alluminio. Si apre e chiude in pochissimo tempo. Piano di cottura in bambù. Completo di armadietto in tessuto per riporre tutti gli accessori per cucinare. Di dimensioni molto compatte quando ripiegato e quindi ideale per tutti gli amanti di minibus, van e camper furgonati. Completo di sacca custodia.

CARATTERISTICHE:

- Struttura Mountless pieghevole in profilo rettangolare di alluminio
- Piedini regolabili in altezza
- Ripiano in MDF con bordo perimetrale in metallo
- Armadietto tessile a 2 ripiani in resistente tessuto di poliestere spalmato
- Con paravento/paraspruzzi in metallo
- Completo di sacca custodia

ELÙTOP DAILY CT

GREYWOOD

ELÙTOP DAILY CT

ART. 0422079N

€ TBC
1/1/-

 100 x 49 x H82 cm

 102 x 15 x 52 cm

 8 kg



NEW
2025



<M>
mountless
the smart
folding system



Mobiletto cucina di alta qualità con robusto telaio pieghevole in profilo quadrato di alluminio. Si monta e si smonta in pochi secondi grazie a speciali snodi. Rivestimento molto resistente in tessuto spalmato su entrambi i lati e piano di lavoro ultraleggero a nido d'ape dal design esclusivo. Resistente, facile da pulire ed elegante. Molto compatto quando è chiuso, è facile da trasportare e da riporre. Tutti i piedini sono regolabili in altezza mediante rotazione.

CARATTERISTICHE:

- Piedini regolabili in altezza
- Tasche porta utensili sui lati
- Incl. borsa per il trasporto





C06



100% Polyester
DEMTEX

MERCURY

CROSS SQUARE



<M>
mountless
the smart
folding system

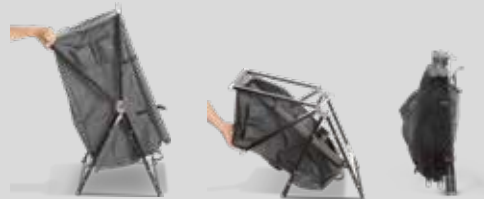

H 90 CM
HIGH
WORKING TOP



MERCURY CROSS HS SQ

ART. 0422055N.C06

€ TBC
1 / 1 / 30

60 x 49 x H140 cm

76,5 x 11 x 63 cm

9,3 kg

Stabile armadietto multiuso con struttura CROSS realizzata in profilato rettangolare di alluminio e snodo centrale in metallo. Tutti i piedini sono regolabili in altezza. Con 4 ripiani interni ed un piano di lavoro in bambù. Sistema Mountless. Con custodia per il trasporto.

MERCURY CROSS COOKER HWT SQ

ART. 0422054N.C06

€ TBC
1 / 1 / 15

92 x 49 x H90 cm

93,5 x 11 x H57 cm

10,9 kg



Pratico mobiletto cucina con struttura CROSS realizzata in profilato rettangolare di alluminio e snodo centrale in metallo. Tutti i piedini sono regolabili in altezza. Con 2 ripiani interni ed un piano di lavoro in bambù. Sistema Mountless. Con paravento e custodia per il trasporto.

MERCURY CROSS LS SQ

ART. 0422050N.C06

€ TBC
1 / 1 / 20

60 x 49 x H100 cm

62 x 11 x 61 cm

8,4 kg

Stabile armadietto multiuso con struttura CROSS realizzata in profilato rettangolare di alluminio e snodo centrale in metallo. Tutti i piedini sono regolabili in altezza. Con 3 ripiani interni ed un piano di lavoro in bambù. Sistema Mountless. Con custodia per il trasporto.



RAZOR ULTRALIGHT CT

ART. 0422003N

€ TBC
1 / 1 / 49



80 x 46 x H82 cm

84 x 38,5 x 37,5 cm

5,9 kg



Mobiletto cucina Outdoor ultraleggero con robusta struttura in alluminio ed elegante piastra di copertura in alluminio arrotolabile con listelli terminali in bambù. L'ampio armadio in tessuto diviso centralmente con 2 ripiani per ciascun scomparto e con rivestimento interno di colore chiaro, offre molto spazio per riporre cibi e stoviglie. Tutte e 4 le gambe sono regolabili in altezza. Montaggio e smontaggio semplici e intuitivi. Dimensioni molto compatte quando ripiegato.

CARATTERISTICHE:

- Armadio in 100% poliestere con rivestimento interno di colore chiaro
- Gambe regolabili in altezza
- Comprende una pratica borsa per il trasporto

HANGAR

HANGAR 2

ART. 0420073N.C03

€ TBC
5 / 20 / 500

40 x 21 cm

Pratica tasca portaoggetti con 2/3 tasche.



HANGAR 10S

ART. 0420075N.C06

€ TBC
5 / 10 / 100

50 x 80 cm

100% Polyester

Soluzione comoda ed elegante per riporre scarpe, sandali e altri oggetti. In totale sono disponibili 10 tasche copribili per l'organizzazione dello spazio di stivaggio del veicolo. Utilizzabile sia all'interno che all'esterno.



HANGAR 3

ART. 0420072N.C03

€ TBC
5 / 20 / 200

60 x 21 cm

100% Polyester



HANGAR 6

ART. 0420071N.C03

€ TBC
5 / 20 / 240

90 x 30 cm

100% Polyester

Pratica tasca portaoggetti con 6 tasche ed un grande specchio.



HANGAR 12

ART. 0420070N.C03

€ TBC
5 / 20 / 360

74 x 39 cm

100% Polyester

Pratica tasca portaoggetti con 12 tasche.



LATIGA

ART. 0422098N

€ TBC
1 / 1 / 13

49 x 33 x H109 cm

49 x 9,5 x H109 cm

4,3 kg

Riponitutto per camping e Outdoor con telaio pieghevole in alluminio e 3 cestini inclinabili di diverse dimensioni. Perfetto per mantenere in ordine la vostra tenda/veranda. Può essere ripiegato dopo l'uso per risparmiare spazio.



SPACE SAVER

HANKY

ART. 0424007N

€ TBC
5 / 10 / -

40,5 x 20 x H75 cm

800 g

100% PES

Armadietto pensile dotato di 3 mensole interne e 4 tasche esterne. Porta in zanzariera con apertura centrale a cerniera.





SNACK

COLLECTION



SNACK BASIC

ART. 0422095N.C03

€ TBC
1 / 1 / 12

	62 x 46 x H90/109 cm
	82 x 50 x 13 cm
	5,5 kg



REMOVABLE



EASY TO USE

OPTIONAL



P. 318
PILLAR
ART. 7427021N.C00 € TBC
8 / 8 / 112

	22/26,5 x 9/12 x H30 cm
	380 g
	100% PP
	5,5 l

Mobiletto cucina da campeggio pieghevole con piano di lavoro arrotolabile, ripiano inferiore con armadio in tessuto removibile e utile paravento e paraspruzzi. Un piedino è regolabile in altezza. Veloce e facile da montare e smontare. Molto compatto quando chiuso e quindi facile da riporre. Completo di robusta borsa per il trasporto.

CARATTERISTICHE:

- Telaio in metallo, verniciato a polvere
- Ripiano arrotolabile in alluminio
- Tessuto in 100% poliestere spalmato



SNACK EASY BLACK

ART. 0426034N.C03

€ TBC
1 / 1 / 21

	141 x 50 x H80,5 cm
	80 x 51 x 12 cm
	7,8 kg



SNACK SQUARE

ART. 0422096N.C03

€ TBC
1 / 1 / 15

	120 x 52 x H90/109 cm
	82 x 52 x 15 cm
	8,2 kg



Mobiletto cucina di nuova concezione con struttura pieghevole extra stabile in profilo quadrato di alluminio. 2 armadi separati offrono ampio spazio per riporre cibo e utensili da cucina. La fornitura include un paravento ed un paraspruzzi, oltre ad una pratica borsa per il trasporto.

CARATTERISTICHE:

- Ripiano arrotolabile: alluminio
- Armadi in 100% poliestere spalmato con porta a cerniera
- Altezza di lavoro: 90 cm (cucina standard)

OPTIONAL

SET MEPO BOX SERENADE P. 269
ART. 0806086N.C6A € TBC
1 / 2 / -



Combinazione molto pratica di cucina da campo e mobile portastoviglie.

CARATTERISTICHE:

- Struttura in alluminio Ø 19/22 mm
- Ripiano laterale in MDF bordato in alluminio
- Mobiletto pensile in 100% poliestere con ripiani interni in MDF
- Facile da ripiegare
- Sacca di trasporto inclusa



DRIVE IN BLACK

ART. 0426032N.C03

€ TBC
1 / 1 / 13



- 100 x 50 x H78/128,5 cm
- 100 x 50 x 14,5 cm
- 11,9 kg

Mobiletto cucina ideale per l'utilizzo Outdoor.

CARATTERISTICHE:

- Ripiano di lavoro in MDF con bordo in alluminio
- Gambe in profilo di acciaio
- Mobiletto pensile a 2 scomparti
- Lavello in plastica
- Robuste maniglie per il trasporto
- Sacca custodia



CHUCK BOX NG

ART. 0426079N.C03

€ TBC
1 / 1 / 15



- 90 x 50 x H82 cm
- 92 x 51 x 13 cm
- 6,5 kg

Mobiletto cucina con struttura in alluminio molto resistente ed un grande piano di lavoro in MDF con bordatura perimetrale in alluminio. L'intero mobiletto trova posto nella borsa di trasporto inclusa. Facile da montare e smontare. L'ampio mobile con chiusura a cerniera offre spazio per riporre alimenti e accessori per la cucina. Include un supporto laterale pieghevole per un lavello collassabile.

CARATTERISTICHE:

- Telaio con gambe pieghevoli
- Pensile con base a griglia in acciaio
- Piedini regolabili in altezza
- Include un paravento ed un paraspruzzi in metallo

OPTIONAL

P. 312

CLEO FOLD-AWAY

ART. 0203064C.C9N € TBC
12 / 12 / 216

- 13 l
- 35,3 x 36,3 x H17 cm
- 35,3 x 36,3 x H6,5 cm
- 640 g



KITCHENETTE

ART. 0422097N.C03

€ TBC
1 / 1 / 15

- 67 x 50 x H93,5 cm
- 67 x 67,5 x 10,5 cm
- 7,9 kg



Mobiletto cucina compatto e pieghevole con piano di lavoro resistente al calore, abbondante spazio di stivaggio, tasche laterali per gli utensili ed un pratico paravento/paraspruzzi in metallo. Ideale per tende e verande di caravan e minibus di dimensioni compatte. Con pratica borsa per il trasporto.





TABLE AND KITCHEN

**STOVIGLIE OUTDOOR
POPOTE**

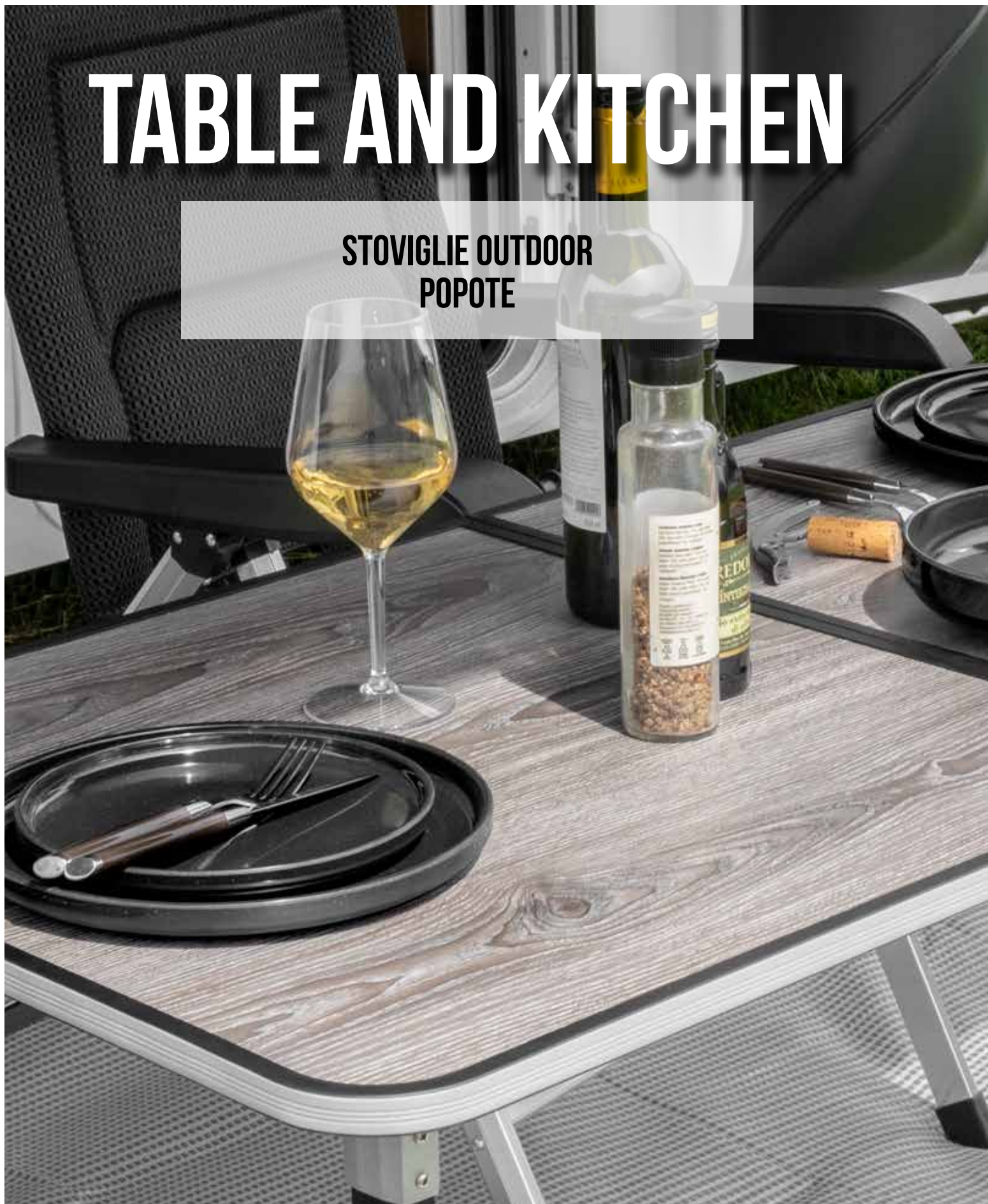

TABLEWARE

COLLECTION



WEB SITE



PLA
TIERRA

208

STONEtouch®

DOLOMIT · ODETTE · TUSCANY
GRANADA · SAVANA

BELLAGIO · VENETIAN · PEARL · METEORE · AMADÈ

210

PREMIUM CLASSIC

COTTERY · KASSANDRA · TIVOLI · GRANYTE
SPACE · SPHERICA

228

SEVEN SEAS

NAUTICAL · BLUE OCEAN

235

ALLROUND

DEEP SEA · COSMIC · SERENADE

238

SQUARE

PANAREA · ENIGMA

241

NATURE

BREEZE · SEQUOIA · ASTRALYS

242

FLASH

ESPRIT · TULIP · BLUEBAY

244

LIVING

BBGRILL · SOUP BOWL
PASTA & SALAD · PIZZA
CHEESE SET

246

KIDS

JUNGLE PARADE · AROUND THE WORLD
BUTTERFLY · FARM · TIME TO TRAVEL
MOLLY · JACK
LET'S GO ADVENTURE

248

GLASSWARE

254

PIRATE NG



100%
RECYCLED
ALUMINIUM



BRUNNER MELAMINE:

100% BPA-FREE

• Facile da pulire

• Lunga durata

• Inodore ed insapore

• Ottima resistenza agli urti

• Resistente al calore ed all'umidità

• Utilizzabile nel congelatore

original design ➤
by Brunner

Gli articoli sono prodotti con la migliore melamina, composto ottenuto dalla combinazione di resine melaminiche e cellulosa che rende particolare questo materiale in quanto rigido e molto leggero.



Freezer

TABLETOP & ENTERTAINING



**ANTISLIP
RUBBER PAD**



RUBBER RING



SILICONE RING



**SILICON
SOFT TOUCH**

Mediante l'utilizzo di una guarnizione in gomma integrata nel fondo delle stoviglie viene data maggiore stabilità. Infatti vengono quasi azzerate le possibilità di scivolamento e caduta e inoltre viene notevolmente ridotto il fastidioso tintinnio nel caso di spostamenti.



ANTISLIP
NOISE REDUCTION



VIDEO

STONEtouch®

PORCELAIN-LIKE AND BREAK-RESISTANT

Nuovo materiale ottenuto da una combinazione di melamina/polvere minerale con eccellenti proprietà funzionali:

- Superficie dura
- Stabilità dimensionale
- Brilla come la porcellana
- Al tocco sembra porcellana
- Adatto per alimenti
- Igienico, facile da pulire
- Inodore e insapore
- Congelabile
- Lavabile in lavastoviglie
- Resistente alla rottura
- Lunga durata

MISE EN PLACE



START YOUR OWN TABLE



WEB SITE



SPACE SAVER

COMPACT STORAGE



11 cm

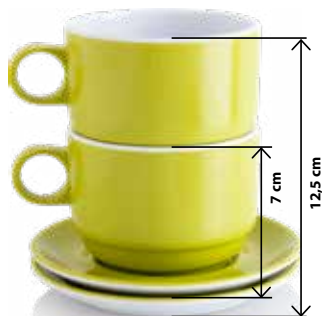

12,5 cm

7 cm

VIP STORAGE BOX

COMES WITH ALL INCLUSIVE VIP STONETOUCH COLLECTION





• 100% senza BPA e adatto all'uso alimentare

• Ottime proprietà isolanti

• Resistente alla corrosione e abrasione

• Riciclabile

• Utilizzabile fino a 90°C (per breve tempo anche a 100°C)

• Ottima resistenza agli urti (anche a basse temperature)

• Utilizzabile nel congelatore

HOT MUG

HEAT RESISTANT

Grazie alle eccellenti proprietà fisiche che contraddistinguono il materiale Resylin, le bevande calde, come il caffè o il tè, possono essere gustate dalla HotMug direttamente dopo la preparazione!

CARATTERISTICHE:

- Resistente alle temperature fino a 100°C/90°C
- Realizzata in Resylin resistente agli urti
- Con anello antiscivolo
- Facili da lavare
- Lavabile in lavastoviglie
- 100% senza BPA e adatto all'uso alimentare

STACKABLE



MUG

CAPPUCCINO



INMANO

ESPRESSO



MICROWAVE-SAFE

PLA

COLLECTION

Le stoviglie in PLA sono prodotte polimerizzando l'acido lattico ottenuto da piante (mais, canna da zucchero --> materie prime rinnovabili) anziché dal petrolio e sono anche biodegradabili o compostabili. Rispetto alla plastica tradizionale, provocano circa il 60% in meno di emissioni di CO₂.

I VANTAGGI DELLE STOVIGLIE IN PLA IN SINTESI:

- Completamente biodegradabili
- Compostabili
- Inodori e insapori
- Adatte per piatti caldi e freddi
- Resistenti alle temperature da -20°C a 120°C (massimo 60 minuti)
- Resistenti al microonde
- Lavabili in lavastoviglie
- Senza BPA



Freezer

BPAfree

Testate secondo la norma DIN EN 13432 / EN 15284



TIERRA

COLLECTION



INFO P. 207



Bicchiere 30 cl

ART. 0830208S.C16

€ TBC
12 / 24 / 1344



Bicchiere 30 cl

ART. 0830208S.C14

€ TBC
12 / 24 / 1344



Bicchiere 30 cl

ART. 0830208S.C02

€ TBC
12 / 24 / 1344



Ciotola Poke ø 19 cm

ART. 0830052N.C16

PACK 2X

€ TBC
6 / 12 / -



Ciotola Poke ø 19 cm

ART. 0830052N.C14

PACK 2X

€ TBC
6 / 12 / -



Ciotola Poke ø 19 cm

ART. 0830052N.C02

PACK 2X

€ TBC
6 / 12 / -

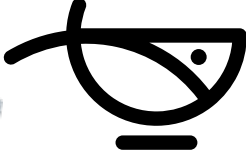
POKE BOWL

Questa versatilissima ciotola in PLA è una scelta sostenibile, realizzata con materiali ecocompatibili. Il suo design resistente e la sua funzionalità multiuso la rendono una pratica aggiunta a qualsiasi cucina, promuovendo uno stile di vita ecoconsapevole.



Il versatile set da pranzo realizzato in materiale PLA ecologico offre una soluzione sostenibile per la tavola. Il suo design elegante e moderno si adatta a qualsiasi apparecchiatura, mentre le opzioni da 8, 12 o 16 pezzi offrono un'ampia flessibilità per riunioni accoglienti o grandi festeggiamenti. Resistente e facile da pulire, questo set da pranzo privilegia sia lo stile che la sostenibilità.

BPAfree



CARATTERISTICHE:

- Realizzato in materiale PLA riciclabile e compostabile
- Colori moderni della terra
- Adatto al microonde
- Design impilabile
- Con anello antislip
- Disponibili set da 8, 12 o 16 pezzi



NEW 2025

2 x Ø 21 cm	2 x Ø 25 cm
2 x Ø 15 cm	2 x 30 cl

4 x Ø 15 cm	4 x Ø 25 cm
4 x Ø 20 cm	

4 x Ø 21 cm	4 x Ø 25 cm
4 x Ø 20 cm	4 x 30 cl

**TÊTE-Â-TÊTE PLA
TIERRA MAGMA**

ART. 0830143N.C16

PCS. 8

€ TBC

6 / 6 / 108



**MIDDAY PLA
TIERRA MAGMA**

ART. 0830148N.C16

PCS. 12

€ TBC

4 / 4 / 88



**LUNCH BOX PLA
TIERRA MAGMA**

ART. 0830155N.C16

PCS. 16

€ TBC

4 / 4 / 60



**TÊTE-Â-TÊTE PLA
TIERRA FOREST**

ART. 0830143N.C14

PCS. 8

€ TBC

6 / 6 / 108



**MIDDAY PLA
TIERRA FOREST**

ART. 0830148N.C14

PCS. 12

€ TBC

4 / 4 / 88



**LUNCH BOX PLA
TIERRA FOREST**

ART. 0830155N.C14

PCS. 16

€ TBC

4 / 4 / 60



**TÊTE-Â-TÊTE PLA
TIERRA COCOA**

ART. 0830143N.C02

PCS. 8

NEW 2025

€ TBC

6 / 6 / 108



**MIDDAY PLA
TIERRA COCOA**

ART. 0830148N.C02

PCS. 12

NEW 2025

€ TBC

4 / 4 / 88



**LUNCH BOX PLA
TIERRA COCOA**

ART. 0830155N.C02

PCS. 16

NEW 2025

€ TBC

4 / 4 / 60



ODETTE

STONEtouch®



Piatto piano ø 25 cm

ART. 0830025N.C3A

€ TBC
12 / 24 / 864



Scodella ø 15 cm

ART. 0830028N.C3A

€ TBC
12 / 48 / -

NEW
2025



Piatto fondo ø 23 cm

ART. 0830026N.C3A

€ TBC
12 / 36 / 756



Scodella ø 17 cm

ART. 0830043N.C3A

€ TBC
12 / 48 / 720



Piatto dessert ø 19 cm

ART. 0830027N.C3A

€ TBC
12 / 48 / 1008



Insalatiera ø 25 cm

ART. 0830030N.C3A

€ TBC
4 / 16 / 288



MIDDAY ODETTE

ART. 0830148N.C3A

PCS. 12

€ TBC
4 / 4 / 88

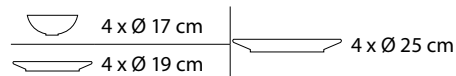

LUNCH BOX ODETTE

ART. 0830155N.C3A

PCS. 16

€ TBC
4 / 4 / 24

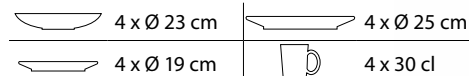

Portauovo

ART. 0830032N.C3A

€ TBC
12 / 72 / 1008



Tazzone 30 cl

ART. 0830051N.C3A

€ TBC
12 / 36 / 540



Tazzina espresso

ART. 0830048N.C3A

€ TBC
6 / 48 / -



6 IN 1 ODETTE

ART. 0830137N.C3A

PCS. 7

€ TBC
4 / 4 / 72

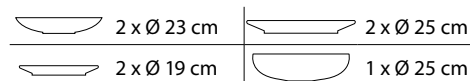

Il set 6 in 1 è il risultato della nostra ricerca di una soluzione elegante, funzionale e salvaspazio da utilizzare per ogni viaggio, per il camping o per picnic all'aria aperta. Realizzato in melamina Stonetouch di alta qualità, è composto da ben 7 pezzi: 2 piatti piani, 2 piatti fondi, 2 piatti dessert più una capiente ciotola per insalata che contiene l'intero set, occupando veramente pochissimo spazio.

Tutti gli elementi del set 6 in 1 convivono con le seguenti caratteristiche:

- Realizzati in speciale melamina Stonetouch alimentare
- Effetto porcellana
- Resistenti agli urti
- Completi di anello Antislip
- Impilabili
- Lavabili in lavastoviglie
- Senza BPA



ODETTE DOUBLE BLACK

STONEtouch®



Piatto piano ø 25 cm

ART. 0830025N.C4C € TBC
12 / 36 / 864



Piatto fondo ø 23 cm

ART. 0830026N.C4C € TBC
12 / 36 / 756



Piatto dessert ø 19 cm

ART. 0830027N.C4C € TBC
12 / 48 / 1008



Scodella ø 15 cm

ART. 0830028N.C4C € TBC
12 / 48 / -

NEW
2025



Scodella ø 17 cm

ART. 0830043N.C4C € TBC
12 / 48 / 720



Insalatiera ø 25 cm

ART. 0830030N.C4C € TBC
4 / 24 / 288



Portauovo

ART. 0830032N.C4C € TBC
12 / 72 / 1008



MIDDAY ODETTE DB

ART. 0830148N.C4C € TBC
PCS. 12

€ TBC
4 / 4 / 88



LUNCH BOX ODETTE DB

ART. 0830155N.C4C € TBC
PCS. 16

€ TBC
4 / 4 / 24



Tazzone 30 cl

ART. 0830051N.C4C € TBC
12 / 36 / 540

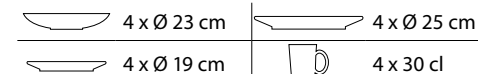
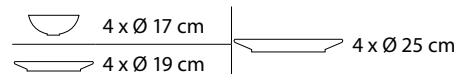

6 IN 1 ODETTE DOUBLE BLACK

ART. 0830137N.C4C € TBC
PCS. 7

€ TBC
4 / 4 / 72

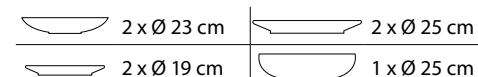

Il set 6 in 1 è il risultato della nostra ricerca di una soluzione elegante, funzionale e salvaspazio da utilizzare per ogni viaggio, per il camping o per picnic all'aria aperta. Realizzato in melamina Stonetouch di alta qualità, è composto da ben 7 pezzi: 2 piatti piani, 2 piatti fondi, 2 piatti dessert più una capiente ciotola per insalata che contiene l'intero set, occupando veramente pochissimo spazio.

Tutti gli elementi del set 6 in 1 convivono con le seguenti caratteristiche:

- Realizzati in speciale melamina Stonetouch alimentare
- Effetto porcellana
- Resistenti agli urti
- Completi di anello Antislip
- Impilabili
- Lavabili in lavastoviglie
- Senza BPA





DOLOMIT

STONEtouch®



MIDDAY DOLOMIT

ART. 0830148N.C2P

PCS. 12

€ TBC
4 / 4 / 88

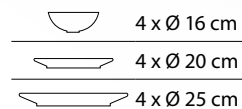

LUNCH BOX DOLOMIT

ART. 0830155N.C2P

PCS. 16

€ TBC
4 / 4 / 40

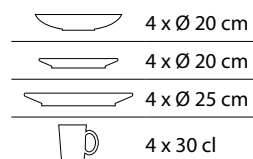

ALL INCLUSIVE DOLOMIT

ART. 0830154N.C2P

PCS. 36

€ TBC
4 / 4 / 48

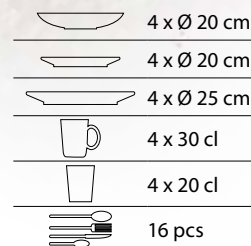

ONDA

ART. 0830214N

✓ 30 cl

PACK 4X



€ TBC
6 / 12 / 168

ONDA & JAZZ WINEGLASS

ART. 0830184C.C9N

✓ 60 cl

PACK 4X



€ TBC
2 / 6 / 72

MUG SET DOLOMIT

ART. 0830051C.C2P

PCS. 4

€ TBC
2 / 8 / 96



DOLOMIT WHITE

STONEtouch®

SET ESPRESSO INMANO

ART. 0830031C.C00 € TBC
PCS. 2 6 / 24 / -



Tazzone Cappuccino

ART. 0830050N.C00 € TBC
12 / 36 / -



Tazzone 30 cl

ART. 0830051N.C00 € TBC
12 / 36 / 540



Piatto piano 25x25 cm

ART. 0830033N.C00 € TBC
6 / 24 / -



Piatto piano ø 25 cm

ART. 0830025N.C00 € TBC
12 / 36 / 864



Piatto fondo ø 20 cm

ART. 0830026N.C00 € TBC
12 / 36 / 756



Piatto dessert ø 20 cm

ART. 0830027N.C00 € TBC
12 / 48 / 1008



Scodella ø 16 cm

ART. 0830043N.C00 € TBC
12 / 48 / 720

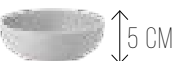

Scodella ø 15 cm

ART. 0830029N.C00 € TBC
12 / 48 / -

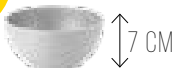

Portauovo

ART. 0830032N.C00 € TBC
12 / 72 / 1008



Bicchiere 30 cl

ART. 0830214S.C00 € TBC
4 / 12 / 1152



Insalatiera ø 25 cm

ART. 0830030N.C00 € TBC
4 / 24 / 1008



TÊTE-Â-TÊTE DOLOMIT WHITE

ART. 0830143N.C00 € TBC
PCS. 8 6 / 6 / 108



	2 x Ø 20 cm		2 x Ø 25 cm
	2 x Ø 16 cm		2 x 30 cl

MIDDAY DOLOMIT WHITE

ART. 0830148N.C00 € TBC
PCS. 12 4 / 4 / 88



	4 x Ø 16 cm		4 x Ø 25 cm
	4 x Ø 20 cm		

LUNCH BOX DOLOMIT WHITE

ART. 0830155N.C00 € TBC
PCS. 16 4 / 4 / 40



	4 x Ø 20 cm		4 x Ø 25 cm
	4 x Ø 20 cm		4 x 30 cl

ALL INCLUSIVE DOLOMIT WHITE

ART. 0830154N.C00 € TBC
PCS. 36 4 / 4 / 48



	4 x Ø 20 cm		4 x Ø 25 cm
	4 x Ø 20 cm		4 x 30 cl

	4 x 20 cl		16 pcs
--	-----------	--	--------

DOLOMIT BLUE

STONEtouch®



SET ESPRESSO INMANO

ART. 0830031C.C28 € TBC
PCS. 2 6 / 24 / -



Tazzone Cappuccino

ART. 0830050N.C28 € TBC
12 / 36 / -



Tazzone 30 cl

ART. 0830051N.C28 € TBC
12 / 36 / 540

Piatto piano 25x25 cm

ART. 0830033N.C28 € TBC
6 / 24 / -



Piatto piano ø 25 cm

ART. 0830025N.C28 € TBC
12 / 36 / 864

Piatto fondo ø 20 cm

ART. 0830026N.C28 € TBC
12 / 36 / 756

Piatto dessert ø 20 cm

ART. 0830027N.C28 € TBC
12 / 48 / 1008

Scodella ø 16 cm

ART. 0830043N.C28 € TBC
12 / 48 / 720

Scodella ø 15 cm

ART. 0830029N.C28 € TBC
12 / 48 / -



Portauovo

ART. 0830032N.C28 € TBC
12 / 72 / 1008

Bicchieri 30 cl

ART. 0830214S.C28 € TBC
4 / 12 / 1152

Insalatiera ø 25 cm

ART. 0830030N.C28 € TBC
4 / 24 / 288

TÊTE-Â-TÊTE DOLOMIT BLUE

ART. 0830143N.C28 € TBC
PCS. 8 6 / 6 / 108



	2 x Ø 20 cm		2 x Ø 25 cm
	2 x Ø 16 cm		2 x 30 cl

MIDDAY DOLOMIT BLUE

ART. 0830148N.C28 € TBC
PCS. 12 4 / 4 / 88



	4 x Ø 16 cm		4 x Ø 25 cm
	4 x Ø 20 cm		

LUNCH BOX DOLOMIT BLUE

ART. 0830155N.C28 € TBC
PCS. 16 4 / 4 / 40



	4 x Ø 20 cm		4 x Ø 25 cm
	4 x Ø 20 cm		4 x 30 cl

ALL INCLUSIVE DOLOMIT BLUE

ART. 0830154N.C28 € TBC
PCS. 36 4 / 4 / 48



	4 x Ø 20 cm		4 x Ø 25 cm
	4 x Ø 20 cm		4 x 30 cl
	4 x 20 cl		16 pcs

DOLOMIT ROSÈ

STONEtouch®

NEW
2025



TÊTE-Â-TÊTE DOLOMIT ROSÈ

ART. 0830143N.C15

PCS. 8

€ TBC

6 / 6 / 108



	2 x Ø 20 cm		2 x Ø 25 cm
	2 x Ø 16 cm		2 x 30 cl

MIDDAY DOLOMIT ROSÈ

ART. 0830148N.C15

PCS. 12

€ TBC

4 / 4 / 88



	4 x Ø 16 cm		4 x Ø 25 cm
	4 x Ø 20 cm		

LUNCH BOX DOLOMIT ROSÈ

ART. 0830155N.C15

PCS. 16

€ TBC

4 / 4 / 60



	4 x Ø 20 cm		4 x Ø 25 cm
	4 x Ø 20 cm		4 x 30 cl

ALL INCLUSIVE DOLOMIT ROSÈ

ART. 0830154N.C15

PCS. 36

€ TBC

4 / 4 / 48



	4 x Ø 20 cm		4 x Ø 25 cm
	4 x Ø 20 cm		4 x 30 cl
	4 x 20 cl		16 pcs

SET ESPRESSO INMANO

ART. 0830031C.C15

PCS. 2

€ TBC

6 / 24 / -

Tazzone Cappuccino

ART. 0830050N.C15

€ TBC

12 / 36 / -

Tazzone 30 cl

ART. 0830051N.C15

€ TBC

12 / 36 / 540

Piatto piano 25x25 cm

ART. 0830033N.C15

€ TBC

6 / 24 / -

Piatto piano ø 25 cm

ART. 0830025N.C15

€ TBC

12 / 36 / 864

Piatto fondo ø 20 cm

ART. 0830026N.C15

€ TBC

12 / 36 / 756

Piatto dessert ø 20 cm

ART. 0830027N.C15

€ TBC

12 / 48 / 1008

Scodella ø 16 cm

ART. 0830043N.C15

€ TBC

12 / 48 / 720

Scodella ø 15 cm

ART. 0830029N.C15

€ TBC

12 / 48 / -

Portauovo

ART. 0830032N.C15

€ TBC

12 / 72 / 1008

Bicchiere 30 cl

ART. 0830214S.C15

€ TBC

4 / 12 / 1152

Insalatiera ø 25 cm

ART. 0830030N.C15

€ TBC

4 / 24 / 288





DOLOMIT GREEN

STONE^{touch}

SET ESPRESSO INMANO

ART. 0830031C.C43 € TBC
PCS. 2 6 / 24 / -



Tazzone Cappuccino

ART. 0830050N.C43 € TBC
12 / 36 / -



Tazzone 30 cl

ART. 0830051N.C43 € TBC
12 / 36 / 540



Piatto piano 25x25 cm

ART. 0830033N.C43 € TBC
6 / 24 / -



Piatto piano ø 25 cm

ART. 0830025N.C43 € TBC
12 / 36 / 864



Piatto fondo ø 20 cm

ART. 0830026N.C43 € TBC
12 / 36 / 756



Piatto dessert ø 20 cm

ART. 0830027N.C43 € TBC
12 / 48 / 1008



Scodella ø 16 cm

ART. 0830043N.C43 € TBC
12 / 48 / 720

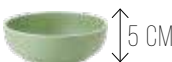

Scodella ø 15 cm

ART. 0830029N.C43 € TBC
12 / 48 / -



Portauovo

ART. 0830032N.C43 € TBC
12 / 72 / 1008



Bicchiere 30 cl

ART. 0830214S.C43 € TBC
4 / 12 / 1152



Insalatiera ø 25 cm

ART. 0830030N.C43 € TBC
4 / 24 / 288

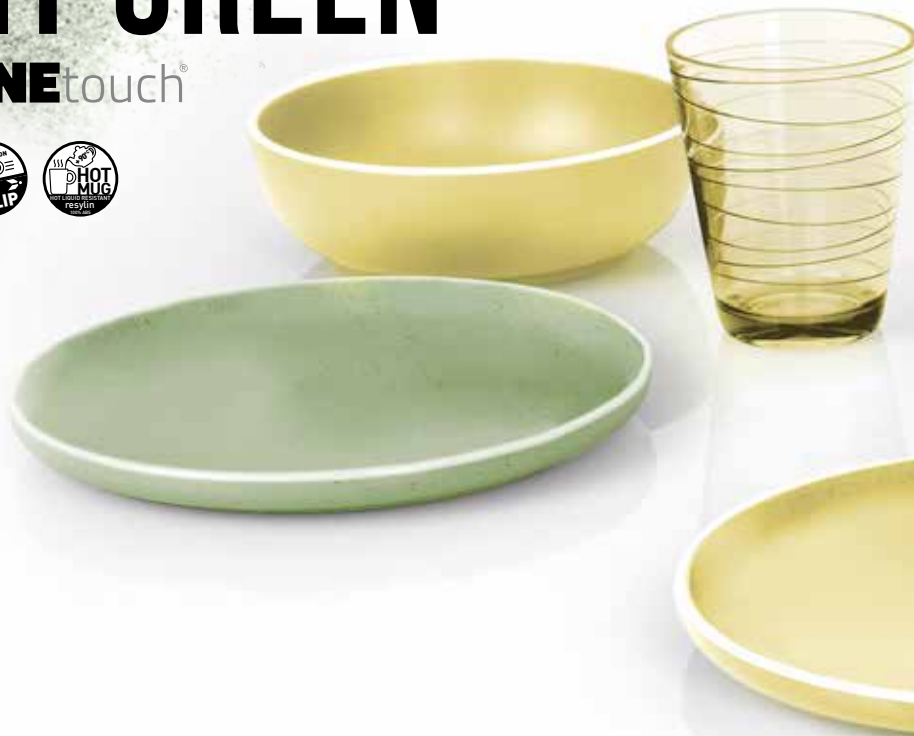

TÊTE-Â-TÊTE DOLOMIT GREEN

ART. 0830143N.C43 € TBC
PCS. 8 6 / 6 / 108



	2 x Ø 20 cm		2 x Ø 25 cm
	2 x Ø 16 cm		2 x 30 cl

MIDDAY DOLOMIT GREEN

ART. 0830148N.C43 € TBC
PCS. 12 4 / 4 / 88



	4 x Ø 16 cm		4 x Ø 25 cm
	4 x Ø 20 cm		4 x Ø 25 cm

LUNCH BOX DOLOMIT GREEN

ART. 0830155N.C43 € TBC
PCS. 16 4 / 4 / 40



	4 x Ø 20 cm		4 x Ø 25 cm
	4 x Ø 20 cm		4 x 30 cl

ALL INCLUSIVE DOLOMIT GREEN

ART. 0830154N.C43 € TBC
PCS. 36 4 / 4 / 48



	4 x Ø 20 cm		4 x Ø 25 cm
	4 x Ø 20 cm		4 x 30 cl
	4 x 20 cl		16 pcs

DOLOMIT YELLOW

STONEtouch®



NEW
2025

TÊTE-Â-TÊTE DOLOMIT YELLOW

ART. 0830143N.C88

PCS. 8

€ TBC
6 / 6 / 108

	2 x Ø 20 cm		2 x Ø 25 cm
	2 x Ø 16 cm		2 x 30 cl

MIDDAY DOLOMIT YELLOW

ART. 0830148N.C88

PCS. 12

€ TBC
4 / 4 / 88

	4 x Ø 16 cm		4 x Ø 25 cm
	4 x Ø 20 cm		4 x Ø 25 cm

LUNCH BOX DOLOMIT YELLOW

ART. 0830155N.C88

PCS. 16

€ TBC
4 / 4 / 40

	4 x Ø 20 cm		4 x Ø 25 cm
	4 x Ø 20 cm		4 x 30 cl

ALL INCLUSIVE DOLOMIT YELLOW

ART. 0830154N.C88

PCS. 36

€ TBC
4 / 4 / 48

	4 x Ø 20 cm		4 x Ø 25 cm
	4 x Ø 20 cm		4 x 30 cl
	4 x 20 cl		16 pcs

SET ESPRESSO INMANO

ART. 0830031C.C88

PCS. 2

€ TBC
6 / 24 / -

Tazzone Cappuccino

ART. 0830050N.C88

PCS. 12

€ TBC
12 / 36 / -

Tazzone 30 cl

ART. 0830051N.C88

PCS. 12

€ TBC
12 / 36 / 540

Piatto piano 25x25 cm

ART. 0830033N.C88

PCS. 6

€ TBC
6 / 24 / -

Piatto piano ø 25 cm

ART. 0830025N.C88

PCS. 12

€ TBC
12 / 36 / 864

Piatto fondo ø 20 cm

ART. 0830026N.C88

PCS. 12

€ TBC
12 / 36 / 756

Piatto dessert ø 20 cm

ART. 0830027N.C88

PCS. 12

€ TBC
12 / 48 / 1008

Scodella ø 16 cm

ART. 0830043N.C88

PCS. 12

€ TBC
12 / 48 / 720

Scodella ø 15 cm

ART. 0830029N.C88

PCS. 12

€ TBC
12 / 48 / -

Portauovo

ART. 0830032N.C88

PCS. 12

€ TBC
12 / 72 / 1008

Bicchiere 30 cl

ART. 0830214S.C88

PCS. 4

€ TBC
4 / 12 / 1152

Insalatiera ø 25 cm

ART. 0830030N.C88

PCS. 4

€ TBC
4 / 24 / 288



DOLOMIT GREY

STONEtouch®

SET ESPRESSO INMANO

ART. 0830031C.C20
PCS. 2

€ TBC
6 / 24 / -



Tazzone Cappuccino

ART. 0830050N.C20

€ TBC
12 / 36 / -



Tazzone 30 cl

ART. 0830051N.C20

€ TBC
12 / 36 / 540



Piatto piano 25x25 cm

ART. 0830033N.C20

€ TBC
6 / 24 / -



Piatto piano ø 25 cm

ART. 0830025N.C20

€ TBC
12 / 36 / 864



Piatto fondo ø 20 cm

ART. 0830026N.C20

€ TBC
12 / 36 / 756



Piatto dessert ø 20 cm

ART. 0830027N.C20

€ TBC
12 / 48 / 1008



Scodella ø 16 cm

ART. 0830043N.C20

€ TBC
12 / 48 / 720

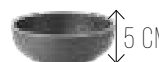

Scodella ø 15 cm

ART. 0830029N.C20

€ TBC
12 / 48 / -



Portauovo

ART. 0830032N.C20

€ TBC
12 / 72 / 1008



Bicchiere 30 cl

ART. 0830214S.C20

€ TBC
4 / 12 / 1152



Insalatiera ø 25 cm

ART. 0830030N.C20

€ TBC
4 / 24 / 288



TÊTE-Â-TÊTE DOLOMIT GREY

ART. 0830143N.C20

PCS. 8

€ TBC
6 / 6 / 108

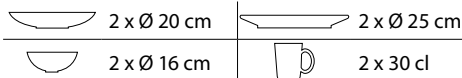

MIDDAY DOLOMIT GREY

ART. 0830148N.C20

PCS. 12

€ TBC
4 / 4 / 88

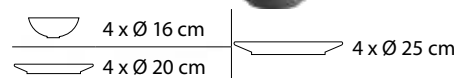

LUNCH BOX DOLOMIT GREY

ART. 0830155N.C20

PCS. 16

€ TBC
4 / 4 / 40

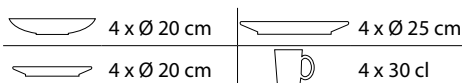

ALL INCLUSIVE DOLOMIT GREY

ART. 0830154N.C20

PCS. 36

€ TBC
4 / 4 / 48

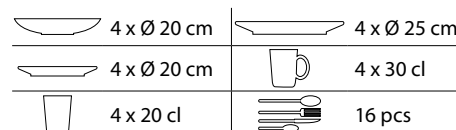

METEORE

STONEtouch®



Piatto piano ø 25 cm

ART. 0830025N.C1X € TBC
12 / 24 / 864



Piatto fondo ø 21 cm

ART. 0830026N.C1X € TBC
12 / 36 / 756



Piatto dessert ø 20 cm

ART. 0830027N.C1X € TBC
12 / 48 / 1008



Tazzone 30 cl

ART. 0830051N.C48 € TBC
12 / 36 / 540



Portauovo

ART. 0830032N.C1X € TBC
12 / 72 / 1008



Scodella ø 15 cm

ART. 0830062N.C1X € TBC
12 / 48 / 1152



ACRYLIC

Insalatiera ø 24 cm

ART. 0830068N.C1X € TBC
4 / 24 / 120



TÊTE-Â-TÊTE METEORE

ART. 0830143N.C1X
PCS. 8

€ TBC
6 / 6 / 108

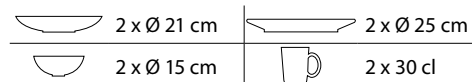

MIDDAY METEORE

ART. 0830148N.C1X
PCS. 12

€ TBC
4 / 4 / 88

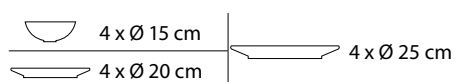

SET ESPRESSO

ART. 0830066C.C48 € TBC
PCS. 2 4 / 24 / -

NEW
2025



MUG SET

ART. 0830051C.C48 € TBC
PCS. 4 2 / 8 / 96



Set tazzoni in Resylin di alta qualità.

LUNCH BOX METEORE

ART. 0830155N.C1X
PCS. 16

€ TBC
4 / 4 / 48

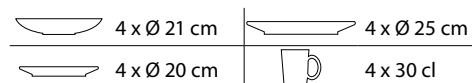

ALL INCLUSIVE VIP METEORE

ART. 0830150N.C1X
PCS. 40

€ TBC
4 / 4 / 20

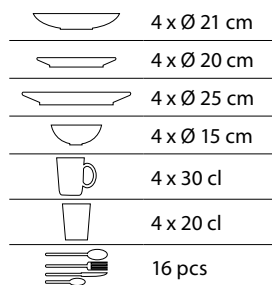

TÊTE-Â-TÊTE TUSCANY

ART. 0830143N.C5T

PCS. 8

€ TBC
6 / 6 / 108



	2 x Ø 21 cm		2 x Ø 26 cm
	2 x Ø 15 cm		2 x 30 cl

MIDDAY TUSCANY

ART. 0830148N.C5T

PCS. 12

€ TBC
4 / 4 / 88



	4 x Ø 15 cm		4 x Ø 26 cm
	4 x Ø 21 cm		

LUNCH BOX TUSCANY

ART. 0830155N.C5T

PCS. 16

€ TBC
4 / 4 / 48



	4 x Ø 21 cm		4 x Ø 26 cm
	4 x Ø 21 cm		4 x 30 cl

ALL INCLUSIVE TUSCANY

ART. 0830154N.C5T

PCS. 36

€ TBC
4 / 4 / 48



	4 x Ø 21 cm		4 x Ø 26 cm
	4 x Ø 21 cm		4 x 30 cl
	4 x 20 cl		16 pcs



TUSCANY

STONEtouch®

Piatto piano ø 26 cm

ART. 0830025N.C5T

€ TBC
12 / 24 / 864



Piatto dessert ø 21 cm

ART. 0830027N.C5T

€ TBC
12 / 48 / 1008



Scodella ø 15 cm

ART. 0830043N.C5T

€ TBC
12 / 48 / 720



Portauovo

ART. 0830032N.C5T

€ TBC
12 / 72 / 1008



Burriera 13,5 x 9,5 x H6,5 cm

ART. 0830099N.C48

€ TBC
12 / 24 / 504



Ciotola ovale 33x23xH7 cm

ART. 0830067N.C5T

€ TBC
6 / 12 / 144



Piatto fondo ø 21 cm

ART. 0830026N.C5T

€ TBC
12 / 36 / 756



Tazzone 30 cl

ART. 0830051N.C5T

€ TBC
12 / 36 / 540



Insalatiera ø 30 cm

ART. 0830030N.C5T

€ TBC
4 / 24 / 288



Bicchiere 25 cl

ART. 0830090N.C48

€ TBC
6 / 48 / 576



Set zuppiera 1x 55 cl / 1x 24x18 cm

ART. 0830049N.C5T

€ TBC
6 / 12 / 96



Piatti da portata 40x28 cm / 35x25 cm

ART. 0830069N.C5T

€ TBC
6 / 6 / 126



ALL INCLUSIVE VIP TUSCANY

ART. 0830150N.C5T

PCS. 40

	4 x Ø 21 cm
	4 x Ø 21 cm
	4 x Ø 26 cm
	4 x Ø 15 cm
	4 x 30 cl
	4 x 20 cl
	16 pcs



€ TBC
4 / 4 / 20

VIP
RECYCLAGE
BOX



SAVANA

STONEtouch®



Piatto piano ø 26 cm

ART. 0830025N.C4P € TBC
12 / 24 / 864



Piatto fondo ø 21 cm

ART. 0830026N.C4P € TBC
12 / 36 / 756



Piatto dessert ø 21 cm

ART. 0830027N.C4P € TBC
12 / 48 / 1008



Tazzone 30 cl

ART. 0830051N.C1C € TBC
12 / 36 / 540



Scodella ø 15 cm

ART. 0830043N.C4P € TBC
12 / 48 / 720



Insalatiera ø 30 cm

ART. 0830030N.C4P € TBC
4 / 24 / 288



Portauovo

ART. 0830032N.C4P € TBC
12 / 72 / 1008



Bicchiere 25 cl

ART. 0830090N.C71 € TBC
6 / 48 / 576



Burreria 13,5 x 9,5 x H6,5 cm

ART. 0830099N.C4P € TBC
12 / 24 / 504



Set zuppiera 1x 55 cl / 1x 24x18 cm

ART. 0830049N.C4P € TBC
6 / 12 / 96



Ciotola ovale 33x23xH7 cm

ART. 0830067N.C4P € TBC
6 / 12 / 144



Piatti da portata 40x28 cm / 35x25 cm

ART. 0830069N.C4P € TBC
6 / 6 / 126



ALL INCLUSIVE VIP SAVANA

ART. 0830150N.C4P
PCS. 40

	4 x Ø 21 cm
	4 x Ø 21 cm
	4 x Ø 26 cm
	4 x Ø 15 cm
	4 x 30 cl
	4 x 20 cl
	16 pcs

VIP
box



€ TBC
4 / 4 / 20



TÊTE-Â-TÊTE SAVANA

ART. 0830143N.C4P
PCS. 8

€ TBC
6 / 6 / 108



	2 x Ø 21 cm		2 x Ø 26 cm
	2 x Ø 15 cm		2 x 30 cl

MIDDAY SAVANA

ART. 0830148N.C4P
PCS. 12

€ TBC
4 / 4 / 88



	4 x Ø 15 cm		4 x Ø 26 cm
	4 x Ø 21 cm		

LUNCH BOX SAVANA

ART. 0830155N.C4P
PCS. 16

€ TBC
4 / 4 / 48



	4 x Ø 21 cm		4 x Ø 26 cm
	4 x Ø 21 cm		4 x 30 cl

ALL INCLUSIVE SAVANA

ART. 0830154N.C4P
PCS. 36

€ TBC
4 / 4 / 48



	4 x Ø 21 cm		4 x Ø 26 cm
	4 x Ø 21 cm		4 x 30 cl
	4 x 20 cl		16 pcs

TÊTE-Â-TÊTE GRANADA

ART. 0830143N.C3S

PCS. 8

€ TBC

6 / 6 / 108



	2 x Ø 21 cm		2 x Ø 26 cm
	2 x Ø 15 cm		2 x 30 cl

MIDDAY GRANADA

ART. 0830148N.C3S

PCS. 12

€ TBC

4 / 4 / 88



	4 x Ø 15 cm		4 x Ø 26 cm
	4 x Ø 21 cm		

LUNCH BOX GRANADA

ART. 0830155N.C3S

PCS. 16

€ TBC

4 / 4 / 48



	4 x Ø 21 cm		4 x Ø 26 cm
	4 x Ø 21 cm		4 x 30 cl

ALL INCLUSIVE GRANADA

ART. 0830154N.C3S

PCS. 36

€ TBC

4 / 4 / 48



	4 x Ø 21 cm		4 x Ø 26 cm
	4 x Ø 21 cm		4 x 30 cl
	4 x 20 cl		16 pcs



GRANADA

STONE touch

Piatto piano ø 26 cm

ART. 0830025N.C3S

€ TBC

12 / 24 / 864



Piatto dessert ø 21 cm

ART. 0830027N.C3S

€ TBC

12 / 48 / 1008



Scodella ø 15 cm

ART. 0830043N.C3S

€ TBC

12 / 48 / 720



Portauovo

ART. 0830032N.C3S

€ TBC

12 / 72 / 1008



Burriera 13,5 x 9,5 x H6,5 cm

ART. 0830099N.C1M

€ TBC

12 / 24 / 504



Ciotola ovale 33x23xH7 cm

ART. 0830067N.C3S

€ TBC

6 / 12 / 144



ALL INCLUSIVE VIP GRANADA

ART. 0830150N.C3S

PCS. 40

	4 x Ø 21 cm
	4 x Ø 21 cm
	4 x Ø 26 cm
	4 x Ø 15 cm
	4 x 30 cl
	4 x 20 cl
	16 pcs



€ TBC

4 / 4 / 20



BELLAGIO

STONEtouch®

Piatto piano ø 26 cm

ART. 0830025N.C4X € TBC
12 / 24 / 864



Piatto fondo ø 21 cm

ART. 0830026N.C4X € TBC
12 / 36 / 756



Piatto dessert ø 21 cm

ART. 0830027N.C4X € TBC
12 / 48 / 1008



Tazzone 30 cl

ART. 0830051N.C06 € TBC
12 / 36 / 540



Scodella ø 15 cm

ART. 0830043N.C4X € TBC
12 / 48 / 720



Insalatiera ø 30 cm

ART. 0830030N.C4X € TBC
4 / 24 / 288



Portauovo

ART. 0830032N.C4X € TBC
12 / 72 / 1008



Bicchiere 25 cl

ART. 0830090N.C71 € TBC
6 / 48 / 576



Burriera 13,5 x 9,5 x H6,5 cm

ART. 0830099N.C06 € TBC
12 / 24 / 504



Set zuppiera 1x 55 cl / 1x 24x18 cm

ART. 0830049N.C4X € TBC
6 / 12 / 96



Ciotola ovale 33x23xH7 cm

ART. 0830067N.C4X € TBC
6 / 12 / 144



Piatti da portata 40x28 cm / 35x25 cm

ART. 0830069N.C4X € TBC
6 / 6 / 126



ALL INCLUSIVE VIP BELLAGIO

ART. 0830150N.C4X

PCS. 40

VIP
BOX

	4 x Ø 21 cm
	4 x Ø 21 cm
	4 x Ø 26 cm
	4 x Ø 15 cm
	4 x 30 cl
	4 x 20 cl
	16 pcs



€ TBC
4 / 4 / 20



TÊTE-Â-TÊTE BELLAGIO

ART. 0830143N.C4X

PCS. 8

€ TBC
6 / 6 / 108



	2 x Ø 21 cm		2 x Ø 26 cm
	2 x Ø 15 cm		2 x 30 cl

MIDDAY BELLAGIO

ART. 0830148N.C4X

PCS. 12

€ TBC
4 / 4 / 88



	4 x Ø 15 cm		4 x Ø 26 cm
	4 x Ø 21 cm		

LUNCH BOX BELLAGIO

ART. 0830155N.C4X

PCS. 16

€ TBC
4 / 4 / 48



	4 x Ø 21 cm		4 x Ø 26 cm
	4 x Ø 21 cm		4 x 30 cl

ALL INCLUSIVE BELLAGIO

ART. 0830154N.C4X

PCS. 36

€ TBC
4 / 4 / 48



	4 x Ø 21 cm		4 x Ø 26 cm
	4 x Ø 21 cm		4 x 30 cl
	4 x 20 cl		16 pcs



Piatto piano ø 25 cm

ART. 0830025N.C9X

€ TBC

12 / 24 / 864



Piatto fondo ø 21 cm

ART. 0830026N.C9X

€ TBC

12 / 36 / 756



Piatto dessert ø 21 cm

ART. 0830027N.C9X

€ TBC

12 / 48 / 1008



Tazzone 30 cl

ART. 0830051N.C9X

€ TBC

12 / 36 / 540



Portauovo

ART. 0830032N.C9X

€ TBC

12 / 72 / 1008



Scodella ø 18 cm

ART. 0830043N.C9X

€ TBC

12 / 48 / 720



Insalatiera ø 28 cm

ART. 0830030N.C9X

€ TBC

4 / 24 / 288



Bicchiere 30 cl

ART. 0830208S.C9X

€ TBC

12 / 24 / 1344



MS
60% Acrylic
40% PS

TÊTE-À-TÊTE VENETIAN

ART. 0830143N.C9X

PCS. 8

€ TBC

6 / 6 / 108



	2 x Ø 21 cm		2 x Ø 25 cm
	2 x Ø 18 cm		2 x 30 cl

MIDDAY VENETIAN

ART. 0830148N.C9X

PCS. 12

€ TBC

4 / 4 / 88



	4 x Ø 18 cm		4 x Ø 25 cm
	4 x Ø 21 cm		

LUNCH BOX VENETIAN

ART. 0830155N.C9X

PCS. 16

€ TBC

4 / 4 / 48



	4 x Ø 21 cm		4 x Ø 25 cm
	4 x Ø 21 cm		4 x 30 cl

ALL INCLUSIVE VIP VENETIAN

ART. 0830150N.C9X

PCS. 40

€ TBC

4 / 4 / 20



	4 x Ø 21 cm
	4 x Ø 21 cm
	4 x Ø 25 cm
	4 x Ø 18 cm
	4 x 30 cl
	4 x 20 cl
	16 pcs

VENETIAN

STONEtouch®



REEL



STOVIGLIE OUTDOOR

Piatto piano ø 25 cm

ART. 0830025N.C3X € TBC
12 / 24 / 864



Piatto fondo ø 21 cm

ART. 0830026N.C3X € TBC
12 / 36 / 756



Piatto dessert ø 21 cm

ART. 0830027N.C3X € TBC
12 / 48 / 1008



Tazzone 30 cl

ART. 0830051N.C3X € TBC
12 / 36 / 540



Portauovo

ART. 0830032N.C3X € TBC
12 / 72 / 1008



Scodella ø 18 cm

ART. 0830043N.C3X € TBC
12 / 48 / 720



Insalatiera ø 28 cm

ART. 0830030N.C3X € TBC
4 / 24 / 288



Bicchiere 30 cl

ART. 0830208S.C3X € TBC
12 / 24 / 1344



MS
60% Acrylic
40% PS

LUNCH BOX
VENETIAN SEA GREEN

ART. 0830155N.C3X
PCS. 16



€ TBC
4 / 4 / 48



	4 x Ø 21 cm		4 x Ø 25 cm
	4 x Ø 21 cm		4 x 30 cl

TÊTE-Â-TÊTE
VENETIAN SEA GREEN

ART. 0830143N.C3X
PCS. 8



€ TBC
6 / 6 / 108



	2 x Ø 21 cm		2 x Ø 25 cm
	2 x Ø 18 cm		2 x 30 cl

MIDDAY
VENETIAN SEA GREEN

ART. 0830148N.C3X
PCS. 12



€ TBC
4 / 4 / 88

	4 x Ø 18 cm		4 x Ø 25 cm
	4 x Ø 21 cm		

ALL INCLUSIVE VIP VENETIAN SEA GREEN

ART. 0830150N.C3X
PCS. 40

€ TBC
2 / 2 / 20



	4 x Ø 21 cm
	4 x Ø 21 cm
	4 x Ø 25 cm
	4 x Ø 18 cm
	4 x 30 cl
	4 x 20 cl
	16 pcs



STONEtouch®





AMADÈ

STONEtouch®



SET WATERGLASS

ART. 0830221N.C71

€ TBC
2 / 6 / 180

✓ 45 cl

PACK 2X



SET WINEGLASS

ART. 0830223N.C71

€ TBC
2 / 6 / 180

✓ 60 cl

PACK 2X



Piatto piano ø 25 cm

ART. 0830025N.C8X

€ TBC
12 / 24 / 864



Piatto fondo ø 20 cm

ART. 0830026N.C8X

€ TBC
12 / 36 / 756



Piatto dessert ø 20 cm

ART. 0830027N.C8X

€ TBC
12 / 48 / 1008



Tazzone 30 cl

ART. 0830051N.C1C

€ TBC
12 / 36 / 540



Scodella ø 15 cm

ART. 0830043N.C8X

€ TBC
12 / 48 / 720



Insalatiera ø 30 cm

ART. 0830030N.C8X

€ TBC
4 / 24 / 288



Portauovo

ART. 0830032N.C8X

€ TBC
12 / 72 / 1008



SET ESPRESSO

ART. 0830066C.C1C

PCS. 2

€ TBC
4 / 24 / -



MIDDAY AMADÈ

ART. 0830148N.C8X

PCS. 12

€ TBC
4 / 4 / 88



TÊTE-Â-TÊTE AMADÈ

ART. 0830143N.C8X

PCS. 8

€ TBC
6 / 6 / 108

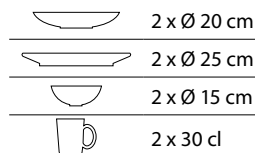

LUNCH BOX AMADÈ

ART. 0830155N.C8X

PCS. 16

€ TBC
4 / 4 / 48

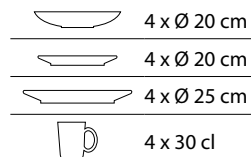

ALL INCLUSIVE VIP AMADÈ

ART. 0830150N.C8X

PCS. 40

€ TBC
4 / 4 / 20

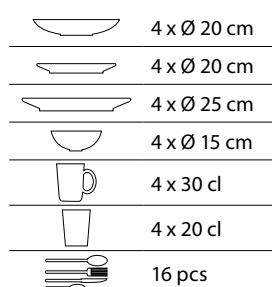

Piatto piano ø 25 cm

ART. 0830025N.C5X € TBC
12 / 24 / 864



Piatto fondo ø 19 cm

ART. 0830026N.C5X € TBC
12 / 36 / 756



Piatto dessert ø 21 cm

ART. 0830027N.C5X € TBC
12 / 48 / 1008



Tazzone 30 cl

ART. 0830051N.C06 € TBC
12 / 36 / 540



Scodella ø 18 cm

ART. 0830043N.C5X € TBC
12 / 48 / 720



Insalatiera ø 28 cm

ART. 0830030N.C5X € TBC
4 / 24 / 288



Portauovo

ART. 0830032N.C5X € TBC
12 / 72 / 1008



SET ESPRESSO

ART. 0830066C.C06 € TBC
PCS. 2 4 / 24 / -

NEW
2025



PEARL

STONEtouch®



REEL

MIDDAY PEARL

ART. 0830148N.C5X
PCS. 12

€ TBC
4 / 4 / 88



4 x Ø 18 cm
4 x Ø 21 cm
4 x Ø 25 cm



TÊTE-Â-TÊTE PEARL

ART. 0830143N.C5X
PCS. 8

€ TBC
6 / 6 / 108



2 x Ø 19 cm
2 x Ø 25 cm
2 x Ø 18 cm
2 x Ø 18 cm



LUNCH BOX PEARL

ART. 0830155N.C5X
PCS. 16

€ TBC
4 / 4 / 48



4 x Ø 19 cm
4 x Ø 21 cm
4 x Ø 25 cm
4 x 30 cl



ALL INCLUSIVE VIP PEARL

ART. 0830150N.C5X
PCS. 40

€ TBC
4 / 4 / 20



4 x Ø 19 cm
4 x Ø 21 cm
4 x Ø 25 cm
4 x Ø 18 cm
4 x 30 cl
4 x 20 cl
16 pcs



VIP
STORAGE
BOX



KASSANDRA

PREMIUM CLASSIC

Piatto piano ø 25 cm

ART. 0830025N.C2K

€ TBC

12 / 24 / 864



Tazzone 30 cl

ART. 0830035N.C2K

€ TBC

12 / 36 / 792



Piatto fondo ø 21 cm

ART. 0830026N.C2K

€ TBC

12 / 36 / 756



Scodella ø 15 cm

ART. 0830043N.C2K

€ TBC

12 / 48 / 720



Piatto dessert ø 20 cm

ART. 0830027N.C2K

€ TBC

12 / 48 / 1008



Insalatiera ø 28 cm

ART. 0830030N.C2K

€ TBC

4 / 24 / 288



SET WATERGLASS BROWNSATIN

ART. 0830183N.C02

€ TBC

2 / 6 / 180

✓ 35 cl

PACK 2X



SET WINEGLASS BROWNSATIN

ART. 0830184N.C02

€ TBC

2 / 6 / 180

✓ 60 cl

PACK 2X



TÊTE-Â-TÊTE KASSANDRA

ART. 0830143N.C2K

PCS. 8

€ TBC

6 / 6 / 108

2 x Ø 21 cm

2 x Ø 25 cm

2 x Ø 15 cm

2 x 30 cl



MIDDAY KASSANDRA

ART. 0830148N.C2K

PCS. 12

€ TBC

4 / 4 / 88

4 x Ø 15 cm

4 x Ø 20 cm

4 x Ø 25 cm



LUNCH BOX KASSANDRA

ART. 0830155N.C2K

PCS. 16

€ TBC

4 / 4 / 48

4 x Ø 21 cm

4 x Ø 20 cm

4 x Ø 25 cm

4 x 30 cl



ALL INCLUSIVE KASSANDRA

ART. 0830154N.C2K

PCS. 36

€ TBC

4 / 4 / 48

4 x Ø 21 cm

4 x Ø 20 cm

4 x Ø 25 cm

4 x 30 cl

4 x 20 cl

16 pcs



TIVOLI

PREMIUM CLASSIC

Piatto piano ø 25 cm

ART. 0830025N.C7X

€ TBC
12 / 24 / 864



Tazzone 30 cl

ART. 0830035N.C7X

€ TBC
12 / 36 / 792



Piatto fondo ø 21 cm

ART. 0830026N.C7X

€ TBC
12 / 36 / 756



Scodella ø 15 cm

ART. 0830043N.C7X

€ TBC
12 / 48 / 720



Piatto dessert ø 20 cm

ART. 0830027N.C7X

€ TBC
12 / 48 / 1008



Insalatiera ø 28 cm

ART. 0830030N.C7X

€ TBC
4 / 24 / 288



SET WATERGLASS BLACKSATIN

ART. 0830183N.C1M

€ TBC
2 / 6 / 180

✓ 35 cl

PACK 2X



SET WINEGLASS BLACKSATIN

ART. 0830184N.C1M

€ TBC
2 / 6 / 90

✓ 60 cl

PACK 2X



TÊTE-À-TÊTE TIVOLI

ART. 0830143N.C7X

PCS. 8

2 x Ø 21 cm

2 x Ø 25 cm

2 x Ø 15 cm

2 x 30 cl



€ TBC
6 / 6 / 108

MIDDAY TIVOLI

ART. 0830148N.C7X

PCS. 12

4 x Ø 15 cm

4 x Ø 20 cm

4 x Ø 25 cm



€ TBC
4 / 4 / 88

LUNCH BOX TIVOLI

ART. 0830155N.C7X

PCS. 16

4 x Ø 21 cm

4 x Ø 20 cm

4 x Ø 25 cm

4 x 30 cl



€ TBC
4 / 4 / 48

ALL INCLUSIVE TIVOLI

ART. 0830154N.C7X

PCS. 36

4 x Ø 21 cm

4 x Ø 20 cm

4 x Ø 25 cm

4 x 30 cl

4 x 20 cl

16 pcs



€ TBC
4 / 4 / 88



COTTERY

PREMIUM CLASSIC

Piatto piano ø 25 cm

ART. 0830025N.C9B

€ TBC

12 / 24 / 864



Piatto fondo ø 21 cm

ART. 0830026N.C9B

€ TBC

12 / 36 / 756



Piatto dessert ø 20 cm

ART. 0830027N.C9B

€ TBC

12 / 48 / 1008



Tazzone 30 cl

ART. 0830035N.C9B

€ TBC

12 / 36 / 792



Scodella ø 15 cm

ART. 0830043N.C9B

€ TBC

12 / 48 / 720



Insalatiera ø 28 cm

ART. 0830030N.C9B

€ TBC

4 / 24 / 288



WATER GLASS GREY

ART. 0830200N.C06

€ TBC

2 / 12 / 288

V 30 cl

PACK 2X



TÊTE-Â-TÊTE COTTERY

ART. 0830143N.C9B

PCS. 8

€ TBC

6 / 6 / 108

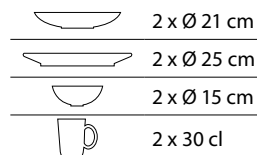

MIDDAY COTTERY

ART. 0830148N.C9B

PCS. 12

€ TBC

4 / 4 / 88

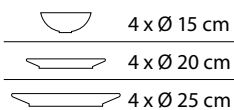

LUNCH BOX COTTERY

ART. 0830155N.C9B

PCS. 16

€ TBC

4 / 4 / 48

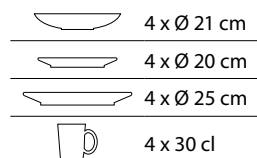

ALL INCLUSIVE COTTERY

ART. 0830154N.C9B

PCS. 36

€ TBC

4 / 4 / 48

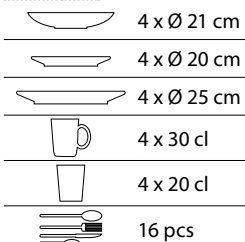

GRANYTE

PREMIUM CLASSIC



Piatto piano ø 24,5 cm

ART. 0830025N.C1M

€ TBC

12 / 36 / 864



Piatto fondo ø 21,5 cm

ART. 0830026N.C1M

€ TBC

12 / 36 / 756



Piatto dessert ø 19,5 cm

ART. 0830027N.C1M

€ TBC

12 / 48 / 1008



Tazzone 30 cl

ART. 0830051N.C1M

€ TBC

12 / 36 / 540



Scodella ø 15 cm

ART. 0830043N.C1M

€ TBC

12 / 48 / 720



Insalatiera ø 23,5 cm

ART. 0830030N.C1M

€ TBC

4 / 24 / 288



Portauovo

ART. 0830032N.C1M

€ TBC

12 / 72 / 1008



Burriera 13,5 x 9,5 x H6,5 cm

ART. 0830099N.C1M

€ TBC

12 / 24 / 504



Insalatiera ø 25 cm

ART. 0830044N.C1M

€ TBC

6 / 6 / 72



SET ESPRESSO

ART. 0830066C.C9X

€ TBC

PCS. 2

4 / 24 / -



ALL INCLUSIVE GRANYTE

ART. 0830154N.C1M

PCS. 36

€ TBC

4 / 4 / 48

	4 x Ø 21,5 cm
	4 x Ø 19,5 cm
	4 x Ø 24,5 cm
	4 x 30 cl
	4 x 20 cl
	16 pcs



MUG SET GRANYTE

ART. 0830051C.C1M

PCS. 4

€ TBC

2 / 8 / 96



Set tazzoni in Resylin di alta qualità.

TÊTE-Â-TÊTE GRANYTE

ART. 0830143N.C1M

PCS. 8

€ TBC

6 / 6 / 108



	2 x Ø 21,5 cm		2 x Ø 24,5 cm
	2 x Ø 15 cm		2 x 30 cl

MIDDAY GRANYTE

ART. 0830148N.C1M

PCS. 12

€ TBC

4 / 4 / 88



	4 x Ø 15 cm		4 x Ø 24,5 cm
	4 x Ø 19,5 cm		

LUNCH BOX GRANYTE

ART. 0830155N.C1M

PCS. 16

€ TBC

4 / 4 / 48



	4 x Ø 21,5 cm		4 x Ø 24,5 cm
	4 x Ø 19,5 cm		4 x 30 cl



Contenitore ø 12x14,5 cm

ART. 0830040N.C34

€ TBC

4 / 48 / 576



Posate insalata

ART. 0830039N.C34

€ TBC

6 / 48 / 576



Cestino pane 24x24 cm

ART. 0830060N.C34

€ TBC

12 / 36 / 504



Tagliere/vassoio 36x24 cm

ART. 0830056N.C34

€ TBC

6 / 12 / 576



Tazza con piattino 25 cl

ART. 0830022N.C34

€ TBC

6 / 36 / 792



SET ESPRESSO

ART. 0830066C.C34

€ TBC

PCS. 2

4 / 24 / -



Portacenere

ART. 0830071N.C34

€ TBC

6 / 48 / 864



SPACE

PREMIUM CLASSIC



TÊTE-Â-TÊTE SPACE

ART. 0830143N.C7B

PCS. 8

€ TBC

6 / 6 / 108



2 x Ø 21 cm

2 x Ø 25 cm

2 x Ø 15 cm

2 x 30 cl

MIDDAY SPACE

ART. 0830148N.C7B

PCS. 12

€ TBC

4 / 4 / 88



4 x Ø 15 cm

4 x Ø 20 cm

4 x Ø 25 cm

LUNCH BOX SPACE

ART. 0830155N.C7B

PCS. 16

€ TBC

4 / 4 / 48



4 x Ø 21 cm

4 x Ø 20 cm

4 x Ø 25 cm

4 x 30 cl

ALL INCLUSIVE SPACE

ART. 0830154N.C7B

PCS. 36+1

€ TBC

4 / 4 / 48



4 x Ø 21 cm

4 x Ø 20 cm

4 x Ø 25 cm

4 x 30 cl

4 x 20 cl

16 pcs

+1

Piatto piano ø 25 cm

ART. 0830025N.C7B € TBC
12 / 36 / 864



Piatto fondo ø 21 cm

ART. 0830026N.C7B € TBC
12 / 36 / 756



Piatto dessert ø 20 cm

ART. 0830027N.C7B € TBC
12 / 48 / 1008



Scodella ø 15 cm

ART. 0830043N.C7B € TBC
12 / 48 / 720



Insalatiera ø 23,5 cm

ART. 0830030N.C7B € TBC
4 / 24 / 288



Portauovo

ART. 0830032N.C7B € TBC
12 / 72 / 1008



Bicchiere 30 cl

ART. 0830185N.C7B € TBC
6 / 12 / 840



Bicchiere 40 cl

ART. 0830187S.C7B € TBC
6 / 12 / 624



Burriera

ART. 0830059N.C7B € TBC
12 / 24 / 264



Vassoio ø 30 cm

ART. 0830080N.C7B € TBC
4 / 8 / 112



Tagliere 23,5x14,5 cm

ART. 0830021N.C7B € TBC
12 / 48 / 960



Lattiera 30 cl

ART. 0830058N.C7B € TBC
12 / 24 / 456



Tazzone 30 cl

ART. 0830051N.C34 € TBC
12 / 36 / 540



Tazza con coperchio 30 cl

ART. 0830023N.C7B € TBC
12 / 48 / 432



MUG SET

ART. 0830051C.C34
PCS. 4

€ TBC
2 / 8 / 96



Set tazzoni in Resylin di alta qualità.

SET MULTIGLASS SPACE

ART. 0830185C.C7B
PCS. 3

€ TBC
2 / 8 / -



Bicchiere sovrapponibile. Materiale: SAN ad uso alimentare. 30 cl

FESTA SPACE

ART. 0830187N.C7B
PCS. 2

€ TBC
6 / 12 / 288



Grande bicchiere impilabile in acrilico alimentare. 40 cl.

SPICE BOX

ART. 0830010N.C9N

€ TBC
24 / 96 / 1728

- Ø 6 x H8 cm
- 56 g
- 4 x 50 ml



Pratico portaspezie in plastica di alta qualità. 4 comparti separati. 6 colori assortiti.

GRATTÙ

ART. 0830017N

€ TBC
12 / 12 / 480



Set grattugia composto da 4 grattugie a fori differenti per sminuzzare alimenti in modo diverso. Materiale: PP/acciaio inox.

MINI SPOON SET

ART. 0830129N.C9N

PCS. 4

€ TBC
24 / 48 / 480



SPOON SET

ART. 0830128N.C9N

PCS. 4

€ TBC
24 / 96 / -





SPHERICA

PREMIUM CLASSIC



Piatto piano ø 24,5 cm

ART. 0830025N.C7T

€ TBC

12 / 24 / 864



Piatto fondo ø 20 cm

ART. 0830026N.C7T

€ TBC

12 / 36 / 756



Piatto dessert ø 20 cm

ART. 0830027N.C7T

€ TBC

12 / 48 / 1008



Scodella ø 16 cm

ART. 0830043N.C7T

€ TBC

12 / 48 / 720



Tazzone 30 cl

ART. 0830035N.C7T

€ TBC

12 / 36 / 792



tritan™
from eastman



SET WINEGLASS SPHERICA

ART. 0830225N.C71

€ TBC

2 / 6 / 72

60 cl

PACK 2X

Portauovo

ART. 0830032N.C7T

€ TBC

12 / 72 / 1008



Insalatiera ø 25 cm

ART. 0830030N.C7T

€ TBC

4 / 24 / 288



ALL INCLUSIVE SPHERICA

ART. 0830154N.C7T

€ TBC

4 / 4 / 48

PCS. 36



	4 x Ø 20 cm		4 x Ø 24,5 cm
	4 x Ø 20 cm		4 x 30 cl
	4 x 20 cl		16 pcs

TÊTE-Â-TÊTE SPHERICA

ART. 0830143N.C7T

€ TBC

6 / 6 / 108

PCS. 8



	2 x Ø 20 cm		2 x Ø 24,5 cm
	2 x Ø 16 cm		2 x 30 cl

MIDDAY SPHERICA

ART. 0830148N.C7T

€ TBC

4 / 4 / 88

PCS. 12



	4 x Ø 16 cm		4 x Ø 24,5 cm
	4 x Ø 20 cm		

SET SPHERICA

ART. 0830160N.C7T

€ TBC

4 / 4 / 56

PCS. 16



	4 x Ø 20 cm		4 x Ø 24,5 cm
	4 x Ø 20 cm		4 x 30 cl

TÊTE-Â-TÊTE NAUTICAL

ART. 0830143N.C8S

PCS. 8

€ TBC
6 / 6 / -

	2 x Ø 23,5 cm		2 x Ø 26 cm
	2 x Ø 15 cm		2 x 30 cl

MIDDAY NAUTICAL

ART. 0830148N.C8S

PCS. 12

€ TBC
4 / 4 / 88

	4 x Ø 15 cm		4 x Ø 26 cm
	4 x Ø 21 cm		

DINNER SERVICE NAUTICAL

ART. 0830151N.C8S

PCS. 16

€ TBC
4 / 4 / 48

	4 x Ø 23,5 cm		4 x Ø 26 cm
	4 x Ø 21 cm		4 x 30 cl

ALL INCLUSIVE NAUTICAL

ART. 0830154N.C8S

PCS. 36+1

€ TBC
4 / 4 / 88

	4 x Ø 23,5 cm		4 x Ø 26 cm
	4 x Ø 21 cm		4 x 30 cl
	4 x 20 cl		16 pcs

NAUTICAL
SEVEN SEAS

Piatto piano ø 26 cm

ART. 0830025N.C8S

€ TBC
12 / 36 / 864

Piatto dessert ø 21 cm

ART. 0830027N.C8S

€ TBC
12 / 48 / 1008

Portauovo

ART. 0830032N.C8S

€ TBC
12 / 72 / 1008

Scodella ø 15 cm

ART. 0830043N.C8S

€ TBC
12 / 48 / 720

Tagliere 23,5x14,5 cm

ART. 0830021N.C8S

€ TBC
12 / 48 / 960

Piatto fondo ø 23,5 cm

ART. 0830026N.C8S

€ TBC
12 / 36 / 756

Bicchiere 30 cl

ART. 0830185N.C8S

€ TBC
6 / 12 / 840

Tazzone 30 cl

ART. 0830024N.C8S

€ TBC
12 / 48 / 480

Insalatiera ø 23,5 cm

ART. 0830030N.C8S

€ TBC
4 / 24 / 288

Lattiera 30 cl

ART. 0830058N.C22

€ TBC
12 / 24 / 456

Burriera 13,5 x 9,5 x H6,5 cm

ART. 0830099N.C22

€ TBC
12 / 24 / 504

Tazzone 30 cl

ART. 0830051N.C22

€ TBC
12 / 36 / 540POLYCARBONATE
HIGH QUALITY DRINKWARE

SET WINEGLASS THANGO BLUE

ART. 0830184N.C22

€ TBC
2 / 6 / 180

V 60 cl

PACK 2X

SET ESPRESSO

ART. 0830066C.C22

€ TBC
4 / 24 / -

PCS. 2

NEW
2025



BLUE OCEAN

SEVEN SEAS



REEL



SET WINEGLASS THANGO BLUE

ART. 0830184N.C22

€ TBC

✓ 60 cl

2 / 6 / 180

PACK 2X



Contenitore ø 12x14,5 cm

ART. 0830040N.C8C

€ TBC

4 / 48 / 576



Posate insalata

ART. 0830039N.C8C

€ TBC

6 / 48 / 576



Portacenera

ART. 0830071N.C22

€ TBC

6 / 48 / 864



Cestino pane 24x24 cm

ART. 0830060N.C22

€ TBC

12 / 36 / 504



Tagliere/vassoio 36x24 cm

ART. 0830056N.C22

€ TBC

6 / 12 / 576



Appetizer 35,5x8,5xH5,5 cm

ART. 0830042N.C8C

€ TBC

4 / 16 / 384



MUG SET

ART. 0830051C.C22

PCS. 4



€ TBC

2 / 8 / 96



Set tazzoni in Resylin di alta qualità.

MUG SET BLUE OCEAN

ART. 0830024C.C8C

PCS. 4

€ TBC

6 / 24 / -



Set tazzoni in melamina di alta qualità.

TÊTE-Â-TÊTE BLUE OCEAN

ART. 0830143N.C8C

PCS. 8

€ TBC

6 / 6 / 108



SET MULTIGLASS BLUE OCEAN

ART. 0830185C.C8C

PCS. 3

€ TBC

2 / 8 / -



Bicchiere sovrapponibile. Materiale: SAN ad uso alimentare. 30 cl

FESTA BLUE OCEAN

ART. 0830187N.C8C

PCS. 2

€ TBC

6 / 12 / 324



Grande bicchiere impilabile in acrilico alimentare. 40 cl.

2 x ø 21 cm

2 x ø 15 cm

2 x ø 25 cm

2 x 30 cl

Piatto piano ø 25 cm

ART. 0830025N.C8C € TBC
12 / 36 / 864



Piatto fondo ø 21 cm

ART. 0830026N.C8C € TBC
12 / 36 / 756



Piatto dessert ø 20 cm

ART. 0830027N.C8C € TBC
12 / 48 / 1008



Tazzone 30 cl

ART. 0830051N.C22 € TBC
12 / 36 / 540



Tazzone 30 cl

ART. 0830024N.C8C € TBC
12 / 48 / 480



Lattiera 30 cl

ART. 0830058N.C8C € TBC
12 / 24 / 456



Coperchio per scodelle ø 15 cm

ART. 0830020N.C8C € TBC
12 / 48 / 1344



Tazza con piattino 25 cl

ART. 0830022N.C8C € TBC
6 / 36 / 792



Burriera

ART. 0830059N.C8C € TBC
12 / 24 / 264



Scodella ø 15 cm

ART. 0830043N.C8C € TBC
12 / 48 / 720



Insalatiera ø 23,5 cm

ART. 0830030N.C8C € TBC
4 / 24 / 288



Portauovo

ART. 0830032N.C8C € TBC
12 / 72 / 1008



Tagliere 23,5x14,5 cm

ART. 0830021N.C8C € TBC
12 / 48 / 960



Vassoio 29,5 x 40 cm

ART. 0830081N.C8C € TBC
6 / 6 / 90



SET ESPRESSO

ART. 0830066C.C22 € TBC
PCS. 2 4 / 24 / -



Bicchiere 30 cl

ART. 0830185N.C8C € TBC
6 / 12 / 840



Bicchiere 40 cl



ART. 0830187S.C8C € TBC
6 / 12 / 624



MIDDAY BLUE OCEAN

ART. 0830148N.C8C
PCS. 12

€ TBC
4 / 4 / 88





-  4 x Ø 15 cm
-  4 x Ø 20 cm
-  4 x Ø 25 cm



LUNCH BOX BLUE OCEAN

ART. 0830155N.C8C
PCS. 16

€ TBC
4 / 4 / 48

-  4 x Ø 21 cm
-  4 x Ø 20 cm
-  4 x Ø 25 cm
-  4 x 30 cl









ALL INCLUSIVE BLUE OCEAN

ART. 0830154N.C8C
PCS. 36+1

€ TBC
4 / 4 / 48



-  4 x Ø 21 cm
-  4 x Ø 20 cm
-  4 x Ø 25 cm
-  4 x 30 cl
-  4 x 30 cl
-  16 pcs





TÊTE-Â-TÊTE DEEP SEA

ART. 0830143N.C7R

PCS. 8

€ TBC

6 / 6 / 108



	2 x Ø 21 cm		2 x Ø 25 cm
	2 x Ø 15 cm		2 x 30 cl

MIDDAY DEEP SEA

ART. 0830148N.C7R

PCS. 12

€ TBC

4 / 4 / 88



	4 x Ø 15 cm		4 x Ø 25 cm
	4 x Ø 20 cm		

LUNCH BOX DEEP SEA

ART. 0830155N.C7R

PCS. 16

€ TBC

4 / 4 / 48



	4 x Ø 21 cm		4 x Ø 25 cm
	4 x Ø 20 cm		4 x 30 cl

ALL INCLUSIVE DEEP SEA

ART. 0830154N.C7R

PCS. 36

€ TBC

4 / 4 / 48



	4 x Ø 21 cm		4 x Ø 25 cm
	4 x Ø 20 cm		4 x 30 cl
	4 x 20 cl		16 pcs

DEEP SEA

ALLROUND



SET ESPRESSO

ART. 0830066C.C06

PCS. 2

€ TBC

4 / 24 / -

NEW 2025



Piatto fondo ø 21 cm

ART. 0830026N.C7R

€ TBC

12 / 36 / 756



Tazzone 30 cl

ART. 0830051N.C06

€ TBC

12 / 36 / 540



Tazza con piattino 25 cl

ART. 0830022N.C06

€ TBC

6 / 36 / 792



Insalatiera ø 23,5 cm

ART. 0830030N.C7R

€ TBC

4 / 24 / 288



Posate insalata

ART. 0830039N.C06

€ TBC

6 / 48 / 576



Burriera 13,5 x 9,5 x H6,5 cm

ART. 0830099N.C06

€ TBC

12 / 24 / 504



Piatto piano ø 25 cm

ART. 0830025N.C7R

€ TBC

12 / 36 / 828



Piatto dessert ø 20 cm

ART. 0830027N.C7R

€ TBC

12 / 48 / 1008

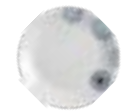

Portauovo

ART. 0830032N.C7R

€ TBC

12 / 72 / 1008



Scodella ø 15 cm

ART. 0830043N.C7R

€ TBC

12 / 48 / 720



Bicchiere 30 cl

ART. 0830185N.C7R

€ TBC

6 / 12 / 840



Cestino pane 24x24 cm

ART. 0830060N.C06

€ TBC

12 / 36 / 504



Portacenera

ART. 0830071N.C06

€ TBC

6 / 48 / 864



Tagliere/vassoio 36x24 cm

ART. 0830056N.C06

€ TBC

6 / 12 / 576



COSMIC

ALLROUND



Piatto piano ø 25 cm

ART. 0830025N.C8A

€ TBC
12 / 36 / 864



Piatto fondo ø 21 cm

ART. 0830026N.C8A

€ TBC
12 / 36 / 756



Piatto dessert ø 20 cm

ART. 0830027N.C8A

€ TBC
12 / 48 / 1008



Tazzone 30 cl

ART. 0830051N.C8A

€ TBC
12 / 36 / 540



Tagliere 23,5x14,5 cm

ART. 0830021N.C8A

€ TBC
12 / 48 / 960



Tazzone 30 cl

ART. 0830035N.C8A

€ TBC
12 / 36 / 792



Scodella ø 15 cm

ART. 0830043N.C8A

€ TBC
12 / 48 / 720



Insalatiera ø 23,5 cm

ART. 0830030N.C8A

€ TBC
4 / 24 / 288



Bicchieri 30 cl

ART. 0830185N.C8A

€ TBC
6 / 12 / 840



Posate insalata

ART. 0830039N.C8A

€ TBC
6 / 48 / 576



Portauovo

ART. 0830032N.C8A

€ TBC
12 / 72 / 1008



Burriera

ART. 0830059N.C8A

€ TBC
12 / 24 / 264



Lattiera 30 cl

ART. 0830058N.C8A

€ TBC
12 / 24 / 456



Vassoio ø 30 cm

ART. 0830080N.C8A

€ TBC
4 / 8 / 112





TÊTE-Â-TÊTE COSMIC

ART. 0830143N.C8A

PCS. 8

€ TBC
6 / 6 / 108

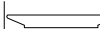

 2 x Ø 21 cm	 2 x Ø 25 cm
 2 x Ø 15 cm	 2 x 30 cl



MIDDAY COSMIC

ART. 0830148N.C8A

PCS. 12

€ TBC
4 / 4 / 88

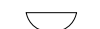

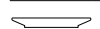
 4 x Ø 15 cm	 4 x Ø 25 cm
 4 x Ø 20 cm	



SET COSMIC

ART. 0830160N.C8A

PCS. 16

€ TBC
4 / 4 / 48

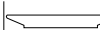
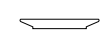

 4 x Ø 21 cm	 4 x Ø 25 cm
 4 x Ø 20 cm	 4 x 30 cl







ALL INCLUSIVE COSMIC

ART. 0830154N.C8A

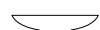
PCS. 36

€ TBC
4 / 4 / 48



 4 x Ø 21 cm	 4 x Ø 25 cm
 4 x Ø 20 cm	 4 x 30 cl
 4 x 20 cl	 16 pcs



SERENADE

ALLROUND



Piatto piano ø 25 cm

ART. 0830025N.C6A

€ TBC

12 / 36 / 864



Piatto fondo ø 21 cm

ART. 0830026N.C6A

€ TBC

12 / 36 / 756



Scodella ø 15 cm

ART. 0830043N.C03

€ TBC

12 / 48 / 720



Piatto dessert ø 20 cm

ART. 0830027N.C6A

€ TBC

12 / 48 / 1008



Tazzone 30 cl

ART. 0830035N.C6A

€ TBC

12 / 36 / 792



Portacenera

ART. 0830071N.C03

€ TBC

6 / 48 / 864



Portauovo

ART. 0830032N.C6A

€ TBC

12 / 72 / 1008



Burriera

ART. 0830059N.C6A

€ TBC

12 / 24 / 264



Tazzone 30 cl

ART. 0830051N.C03

€ TBC

12 / 36 / 540



MELANGE

ART. 0830006N

€ TBC

22,3 x ø 5 cm 12 / 24 / 912



Bicchiere 40 cl

ART. 0830187S.C6A

€ TBC

6 / 12 / 624



Lattiera 30 cl

ART. 0830058N.C03

€ TBC

12 / 24 / 456



TÊTE-Â-TÊTE SERENADE

ART. 0830143N.C6A

€ TBC

6 / 6 / 108

PCS. 8



MIDDAY SERENADE

ART. 0830148N.C6A

€ TBC

4 / 4 / 88

PCS. 12



Contenitore ø 12x14,5 cm

ART. 0830040N.C03

€ TBC

4 / 48 / 576



Posate insalata

ART. 0830039N.C03

€ TBC

6 / 48 / 576



Tagliere/vassoio 36x24 cm

ART. 0830056N.C03

€ TBC

6 / 12 / 576

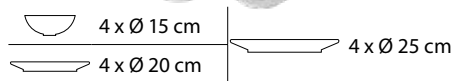
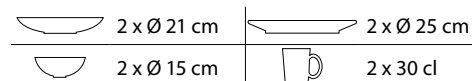

SET SERENADE

ART. 0830160N.C6A

€ TBC

4 / 4 / 56

PCS. 16



ALL INCLUSIVE SERENADE

ART. 0830154N.C6A

€ TBC

4 / 4 / 48

PCS. 36



Cestino pane 24x24 cm

ART. 0830060N.C03

€ TBC

12 / 36 / 504



Appetizer 35,5x8,5xH5,5 cm

ART. 0830042N.C03

€ TBC

4 / 16 / 384

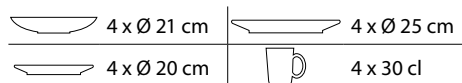
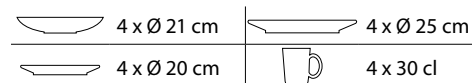

OLIAC

ART. 0830000N.C4N

€ TBC

12 / 12 / -

✓ 2x 130 ml



PANAREA

SQUARE

Piatto piano 25x25 cm

ART. 0830320N.C2X

€ TBC

24 / 24 / 504



Piatto fondo 23x23 cm

ART. 0830310N.C2X

€ TBC

24 / 24 / 504



Piatto dessert 20x20 cm

ART. 0830330N.C2X

€ TBC

24 / 24 / 504



Scodella 15x15 cm

ART. 0830350N.C2X

€ TBC

24 / 24 / 504



Tazzone 35 cl

ART. 0830140N.C2X

€ TBC

24 / 24 / 768



SET PANAREA

ART. 0830161N.C2X

PCS. 16

€ TBC

4 / 4 / 56

	4x 23 x 23 cm
	4x 20 x 20 cm
	4x 25 x 25 cm
	4 x 35 cl

ALL INCLUSIVE PANAREA

ART. 0830154N.C2X

PCS. 36

€ TBC

4 / 4 / 48

	4x 23 x 23 cm
	4x 20 x 20 cm
	4x 25 x 25 cm
	4 x 35 cl
	4 x 20 cl
	16 pcs

Piatto piano 25x25 cm

ART. 0830320N.C5L

€ TBC

24 / 24 / 504



Piatto fondo 23x23 cm

ART. 0830310N.C5L

€ TBC

24 / 24 / 504



Piatto dessert 20x20 cm

ART. 0830330N.C5L

€ TBC

24 / 24 / 504



Scodella 15x15 cm

ART. 0830350N.C5L

€ TBC

24 / 24 / 1344



Tazzone 35 cl

ART. 0830140N.C5L

€ TBC

24 / 24 / 768



ENIGMA

SQUARE



SET ENIGMA

ART. 0830161N.C5L

PCS. 16

€ TBC

4 / 4 / 80

	4x 23 x 23 cm
	4x 20 x 20 cm
	4x 25 x 25 cm
	4 x 35 cl

ALL INCLUSIVE ENIGMA

ART. 0830154N.C5L

PCS. 36

€ TBC

4 / 4 / 48

	4x 23 x 23 cm
	4x 20 x 20 cm
	4x 25 x 25 cm
	4 x 35 cl
	4 x 20 cl
	16 pcs



BREEZE

NATURE



MIDDAY BREEZE

ART. 0830148N.C3B

€ TBC
4 / 4 / 88

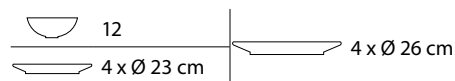

SET BREEZE

ART. 0830160N.C3B

PCS. 16

€ TBC
4 / 4 / 48

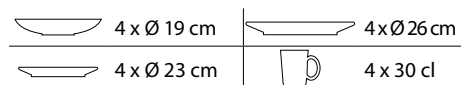

ASTRALYS

NATURE



MIDDAY ASTRALYS

ART. 0830148N.C5S

€ TBC
4 / 4 / 88

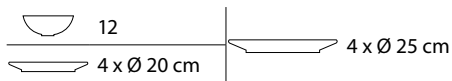

SET ASTRALYS

ART. 0830160N.C5S

PCS. 16

€ TBC
4 / 4 / 56

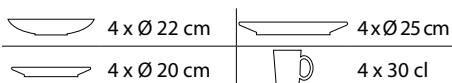

SEQUOIA

NATURE



MIDDAY SEQUOIA

ART. 0830148N.C2A

€ TBC
4 / 4 / 88

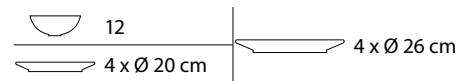

SET SEQUOIA

ART. 0830160N.C2A

PCS. 16

€ TBC
4 / 4 / 56

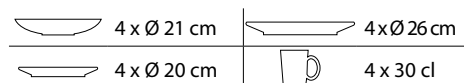



ESPRIT

FLASH



SET ESPRIT

ART. 0830160N.C5B

PCS. 16

€ TBC
4 / 4 / 84

	4 x Ø 21 cm
	4 x Ø 20 cm
	4 x Ø 25 cm
	4 x 30 cl



ALL INCLUSIVE ESPRIT

ART. 0830154N.C5B

PCS. 36

€ TBC
4 / 4 / 48

	4 x Ø 21 cm		4 x Ø 25 cm
	4 x Ø 20 cm		4 x 30 cl
	4 x 20 cl		16 pcs



TULIP

FLASH



SET TULIP

ART. 0830160N.C4E

PCS. 16

€ TBC
4 / 4 / 56

	4 x Ø 21 cm
	4 x Ø 20 cm
	4 x Ø 25 cm
	4 x 30 cl



ALL INCLUSIVE TULIP

ART. 0830154N.C4E

PCS. 36

€ TBC
4 / 4 / 48

	4 x Ø 21 cm		4 x Ø 25 cm
	4 x Ø 20 cm		4 x 30 cl
	4 x 20 cl		16 pcs



BLUEBAY

FLASH





MIDDAY BLUEBAY

ART. 0830148N.C6T

PCS. 12

€ TBC
4 / 4 / 88

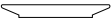
	4 x Ø 13,5 cm
	4 x Ø 21 cm
	4 x Ø 25 cm







SET BLUEBAY

ART. 0830160N.C6T

PCS. 16

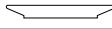
€ TBC
4 / 4 / 56

	4 x Ø 21 cm
	4 x Ø 20 cm
	4 x Ø 25 cm
	4 x 30 cl









ALL INCLUSIVE BLUEBAY

ART. 0830154N.C6T

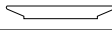
PCS. 36

€ TBC
4 / 4 / 48

	4 x Ø 21 cm
	4 x Ø 20 cm
	4 x Ø 25 cm
	4 x 20 cl
	4 x 30 cl
	16 pcs



Melamineware
Great Colours. Great Passion!



BBGRILL

LIVING



Piatto piano 31x27 cm

ART. 0830045N.C5R

€ TBC

12 / 24 / 576



Appetizer 3x ø11cm / 40cm

ART. 0830041N.C5R

€ TBC

4 / 16 / 384



Scodella 16x14 cm

ART. 0830047N.C5R

€ TBC

12 / 24 / 480



Insalatiera 31x24,5 cm

ART. 0830046N.C5R

€ TBC

6 / 12 / 192

SOUP BOWL

LIVING



Set zuppiera 1x 55 cl / 1x 24x18 cm

ART. 0830049N.C5T

€ TBC

6 / 12 / 96



Set zuppiera 1x 55 cl / 1x 24x18 cm

ART. 0830049N.C3S

€ TBC

6 / 12 / 96



Set zuppiera 1x 55 cl / 1x 24x18 cm

ART. 0830049N.C4P

€ TBC

6 / 12 / 96



Set zuppiera 1x 55 cl / 1x 24x18 cm

ART. 0830049N.C4X

€ TBC

6 / 12 / 96



100% Melamine

APPETIZER

ART. 0830042N.C06

€ TBC

4 / 16 / 384

35,5 x 8,5 x H5,5 cm



CHEESE SET

ART. 0830134N

€ TBC

4 / 4 / 80

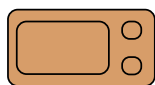

25 x 15,5 cm

Slate

40 x 20,5 cm



9 x 9 x H5 cm

100% Melamine



GREENKICK

ART. 0830044N.C06

€ TBC

6 / 6 / 72



Ø 25 cm



ART. 0830044N.C4P



ART. 0830044N.C1M



PASTA & SALAD



LIVING



PASTA & SALAD SET

ART. 0830132N

PCS. 5

€ TBC
4 / 4 / 48
 1 x Ø 29,5 cm
 4 x Ø 20 cm

PIZZA

LIVING



SET PIZZA

ART. 0830131N

PCS. 2

€ TBC
6 / 6 / 48
 Ø 37,5 cm



BREAD BOARD

ART. 0830056N.C06

 36 x 24 cm
€ TBC
6 / 12 / 576

BREAD BASKET

ART. 0830060N.C06

 24 x 24 cm
€ TBC
12 / 36 / 504

BUTTER BOX



ART. 0830099N.C06

 13,5 x 9,5 x H6,5 cm
€ TBC
12 / 24 / 504



X kids collection



 1x 220 ml
 1X
 1x 20 x 23 cm

SILICON SOFT TOUCH



JUNGLE PARADE 6M+

ART. 0830072N
PCS. 3



100% silicone

AROUND THE WORLD 6M+

€ TBC
6 / 12 / 120
ART. 0830076N
PCS. 3





100% silicone

€ TBC
6 / 12 / 120

KIDS

COLLECTION

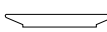

	1x Ø 16 cm		1x Ø 22 cm
	2 pcs		1x 20 cl

BUTTERFLY 3+

ART. 0830073N
PCS. 5



€ TBC
6 / 12 / 120

FARM 3+

ART. 0830074N
PCS. 5



€ TBC
6 / 12 / 96

TIME TO TRAVEL 3+

ART. 0830077N
PCS. 5



€ TBC
6 / 12 / 120

MOLLY 3+

ART. 0830078N
PCS. 5



€ TBC
6 / 12 / 120

JACK 3+

ART. 0830079N
PCS. 5



€ TBC
6 / 12 / 96

LET'S GO ADVENTURE 3+

ART. 0830070N
PCS. 5



€ TBC
6 / 12 / 96



EASTWOOD

ART. 0830115N

PCS. 12

€ TBC
4 / 4 / 48

Classico set stoviglie da 12 pezzi. Realizzato in acciaio smaltato con anello di protezione in acciaio inox.

CARATTERISTICHE:

- Acciaio di alta qualità con rivestimento in smalto
- Superficie antiruggine
- Robuste, resistenti e leggere
- Perfette per le attività all'aria aperta
- Igieniche e facili da pulire

	4x 50 cl
	4 x Ø 18 cm
	4 x Ø 24 cm



BIWAK

ART. 0832043N

€ TBC
10 / 100 / 600

100 g

Set posate outdoor in acciaio inox di ottima qualità. Il set comprende coltello, forchetta e cucchiaio collegati mediante un anello apribile.



LEGEND KARAMUG

ART. 0820068N

€ TBC
12 / 48 / -

Ø 7 x H8 cm

113 g

200 ml



Tazzone termoisolante a doppia parete realizzato in acciaio inox.



REEL



1

2

Melamineware



HUNGRY

ART. 0830110N.C30

€ TBC
12 / 12 / 360



Ø 17,5/14 x 6 cm

INOX
Stainless Steel

HUNGRY XL

ART. 0830111N.C30

€ TBC
12 / 12 / 360



Ø 22/18,5 x 6 cm

Ciotola per cani realizzata in resistente melamina con inserto in acciaio inox e pratico anello antiscivolo. Ideale per l'amico più fedele del camperista.

CUTRAY

ART. 0420010N



 33,5 x 24,5 x H4,5 cm

Portaposate in materiale plastico.

MANTIS

ART. 0420008N

€ TBC
15 / 75 / 450



 39,5 x 31,5 x H6 cm

 23,5 x 31,5 x H6 cm

 100% PP

€ TBC
10 / 50 / -



Portaposate da cassetto. Regolabile, a 7 scomparti, con inserto superiore riposizionabile.

CHOPPER

ART. 0420002N



 32 x 23 cm

Tagliere in bambù utilizzabile su entrambi i lati.

DELICIA

ART. 0832005N

€ TBC
12 / 48 / 288



water repellent

COLORS  

 30 x 45 cm

 Syntex

€ TBC
12 / 12 / 864



Tovaglietta decorativa, dà un tocco di colore alla tavola. Pratica, molto resistente e di facile pulizia.





DELICE

ART. 0832016N

€ TBC
5 / 20 / 360

Set posate composto da 16 pezzi. Esecuzione molto solida con anima in metallo.

COLORS



SAVOR

ART. 0832018N.C22

€ TBC
5 / 20 / 360

Set posate in acciaio inox composto da 16 pezzi. Manico in materiale plastico con foro per appendere.



PARTY

ART. 0832015N

€ TBC
5 / 20 / 320

Posate in acciaio inox anti-ruggine con manico anti-sciolo. Set da 16 pezzi.

COLORS



PATIS

ART. 0832009N.C25

€ TBC
5 / 20 / 360

Set posate composto da 16 pezzi.

AMYLA

ART. 0832008N.C06

€ TBC
5 / 20 / 360

Set posate dal design moderno, composto da 16 pezzi. Esecuzione molto solida con anima in metallo.

**SAPORA**

ART. 0832011N

COLORS

C22 C48 C1C

€ TBC
5 / 20 / 360

Set posate composto da 16 pezzi. Esecuzione molto solida con anima in metallo.

JOIA

ART. 0832017N

€ TBC
5 / 20 / 360

Set posate composto da 16 pezzi in acciaio inossidabile.



CUVÉE

COLLECTION

SCRATCH RESISTANT
HIGH IMPACT RESISTANCE
POLYCARBONATE
HIGH QUALITY DRINKWARE
PERFECTLY TRANSPARENT
LIGHTWEIGHT



Freezer



WATERGLASS



WHITE WINEGLASS

tritan
from eastman

WINEGLASS



R&W WINEGLASS



RED WINEGLASS



PROSECCO GLASS

WATER GLASS

ART. 0830200N.C71

€ TBC
2 / 12 / 288

✓ 30 cl

PACK 2X



WHITE WINEGLASS

ART. 0830171N.C71

€ TBC
2 / 6 / 126

✓ 30 cl

PACK 2X



WINEGLASS

ART. 0830191N.C71

€ TBC
2 / 6 / 180

✓ 45 cl

PACK 2X

tritan
from eastman



R&W WINEGLASS

ART. 0830166N.C71

€ TBC
2 / 6 / 90

✓ 69 cl

PACK 2X



RED WINEGLASS

ART. 0830184N.C71

€ TBC
2 / 6 / 108

✓ 60 cl

PACK 2X



PROSECCO GLASS

ART. 0830205N.C71

€ TBC
2 / 8 / 96

✓ 25 cl

PACK 2X



VIDEO

Il polycarbonato è un materiale trasparente (polimero) che riunisce molte caratteristiche utili di metallo, vetro e materiali sintetici: altissima resistenza agli urti • antigraffio • alta resistenza alla temperatura • ottime caratteristiche ottiche (trasparenza) • autoestinguento.

WATER GLASS GREY

ART. 0830200N.C06

€ TBC
2 / 12 / 288

✓ 30 cl

PACK 2X





RISERVA

COLLECTION

85^{max}°C

Freezer



PROSECCO GLASS

RED
WINEGLASS

R&W WINEGLASS

WHITE
WINEGLASS

WINEGLASS

WATERGLASS

WATER GLASS

ART. 0830216N.C71

€ TBC
6 / 12 / 216
 30 cl

PACK 2X



WINEGLASS

ART. 0830218N.C71

€ TBC
2 / 6 / 108
 45 cl

PACK 2X



WHITE WINEGLASS

ART. 0830219N.C71

€ TBC
2 / 6 / 180
 42 cl

PACK 2X



R&W WINEGLASS

ART. 0830213N.C71

€ TBC
2 / 6 / 108
 58 cl

PACK 2X



RED WINEGLASS

ART. 0830220N.C71

€ TBC
2 / 6 / 72
 72 cl

PACK 2X



PROSECCO GLASS

ART. 0830217N.C71

€ TBC
2 / 6 / 156
 25 cl

PACK 2X



SPHERICA

SET WINEGLASS SPHERICA

ART. 0830225N.C71

€ TBC
2 / 6 / 72
 60 cl

PACK 2X



tritan™

from eastman

INFO P. 256



AMADÈ

COLLECTION



WATERGLASS



R&W WINEGLASS



WHITE
WINEGLASS



WINEGLASS

SET WATERGLASS

ART. 0830221N.C71 € TBC
2 / 6 / 180

✓ 45 cl

PACK 2X



SET R&W WINEGLASS

ART. 0830224N.C71 € TBC
2 / 6 / 90

✓ 58 cl

PACK 2X



SET WHITE WINEGLASS

ART. 0830226N.C71 € TBC
2 / 6 / 108

✓ 42 cl

PACK 2X



SET WINEGLASS

ART. 0830223N.C71 € TBC
2 / 6 / 180

✓ 60 cl

PACK 2X



tritan™
from eastman

Il materiale plastico Tritan è un'alternativa equivalente al policarbonato ampiamente utilizzato. Tritan è stato sviluppato specificamente come alternativa senza BPA al policarbonato, noto per contenere quantità minori di BPA. Perfettamente adatto per la produzione di bicchieri in plastica infrangibili che assomigliano esattamente a bicchieri di vetro, bicchieri da vino o eleganti calici.

CARATTERISTICHE SPECIALI DI TRITAN

- I prodotti Tritan sono trasparenti, durevoli e sicuri
- Tritan non contiene BPA, BPS o altri bisfenoli
- Tritan ha una resistenza alla rottura molto maggiore rispetto ad altre materie plastiche e vetro
- Tritan non si ammacca
- Tritan ha un look ed un feel simile al vetro
- Il Tritan non diventa nebuloso o torbido dopo il lavaggio
- Tritan può essere sagomato come desiderato (in produzione)
- Tritan è più leggero del vetro
- Tritan è sicuro per i bambini
- Tritan è in grado di resistere a temperature fino a 85°C

CLASSIC

TRITAN COLLECTION

TRITAN



WATERGLASS CLASSIC

ART. 0830227N.C71

€ TBC
2 / 6 / -
 39 cl

PACK 2X



WINEGLASS CLASSIC

ART. 0830229N.C71

€ TBC
2 / 6 / -
 47 cl

PACK 2X



SCRATCH RESISTANT
HIGH IMPACT RESISTANCE

POLYCARBONATE
HIGH QUALITY DRINKWARE

PERFECTLY TRANSPARENT
LIGHTWEIGHT



CLASSIC WINEGLASS ANTISLIP

ART. 0830234N.C71

€ TBC
6 / 6 / -
 53 cl

PACK 2X



Questa straordinaria collezione di bicchieri con base antiscivolo di nuova concezione è l'emblema dell'affidabilità e della praticità per i camperisti. Realizzata in pregiato materiale PC infrangibile, questa gamma funzionale garantisce un'esperienza di campeggio senza preoccupazioni. Idratazione garantita durante le vostre avventure senza compromettere lo stile o la funzionalità. La libertà di esplorare i grandi spazi aperti sorseggiando da questi bicchieri durevoli ed eco-friendly.





CORALUX

COLLECTION



MS
60% Acrylic
40% PS

SET WATERGLASS

ART. 0830230N.C14

€ TBC

2 / 6 / -

35 cl

PACK 2X

SET WINEGLASS

ART. 0830231N.C14

€ TBC

2 / 6 / -

40 cl

PACK 2X

SET WATERGLASS

ART. 0830230N.C25

€ TBC

2 / 6 / 180

35 cl

PACK 2X

SET WINEGLASS

ART. 0830231N.C25

€ TBC

2 / 6 / 180

40 cl

PACK 2X

SET BOWLS

ART. 0830232N.C25

€ TBC

2 / 6 / 144

80 cl

PACK 2X



THANGO

BLACK & WHITE

BRÜNER
POLYCARBONATE
HIGH QUALITY DRINKWARE



SET WINEGLASS THANGO BLACK & WHITE

ART. 0830184N.C4N

€ TBC

2 / 6 / 180

60 cl

PACK 2X



SET WINEGLASS THANGO BLACK

ART. 0830184N.C03

€ TBC

2 / 6 / 180

60 cl

PACK 2X



SATIN

COLLECTION



SET WATERGLASS BLACKSATIN

ART. 0830183N.C1M € TBC
2 / 6 / 180

✓ 35 cl

PACK 2X



SET WINEGLASS BLACKSATIN

ART. 0830184N.C1M € TBC
2 / 6 / 90

✓ 60 cl

PACK 2X



SET WATERGLASS BROWNSATIN

ART. 0830183N.C02 € TBC
2 / 6 / 180

✓ 35 cl

PACK 2X



SET WINEGLASS BROWNSATIN

ART. 0830184N.C02 € TBC
2 / 6 / 180

✓ 60 cl

PACK 2X





SCRATCH RESISTANT
HIGH IMPACT RESISTANCE
POLYCARBONATE
HIGH QUALITY DRINKWARE
PERFECTLY TRANSPARENT
LIGHTWEIGHT

tritan™
from eastman

BEERGLASS

COLLECTION

tritan™
from eastman



PINT



TULIP



SPECIAL



PILSNER



MUNICH



CLASSIC

SET BEERGLASS PINT

ART. 0830210N.C71

€ TBC

6 / 12 / 144

57 cl

PACK 2X



SET BEERGLASS TULIP

ART. 0830211N.C71

€ TBC

12 / 12 / 144

46 cl

PACK 2X

tritan™
from eastman



SET BEERGLASS SPECIAL

ART. 0830173N.C71

€ TBC

6 / 12 / 108

50 cl

PACK 2X



SET BEERGLASS PILSNER

ART. 0830209N.C71

€ TBC

8 / 8 / 96

44 cl

PACK 2X

tritan™
from eastman



SET BEERGLASS MUNICH

ART. 0830196N.C71

€ TBC

2 / 6 / 168

55 cl

PACK 2X



SET BEERGLASS CLASSIC

ART. 0830174N.C71

€ TBC

2 / 6 / 108

60 cl

PACK 2X



PC-CARAFFE

ART. 0830193N

€ TBC

V 520 ml

4 / 12 / 288

COLORS

C34 C00

**PC-CARAFFE**

ART. 0830172N

€ TBC

V 1000 ml

4 / 12 / 240

COLORS

C34 C00

**VIAL**

ART. 0830203N.C71

€ TBC

V 900 ml

2 / 12 / 192

**COGNAC**

tritan[™]

from eastman
SET COGNAC

ART. 0830202N.C71

€ TBC

6 / 6 / 216

V 43 cl

PACK 2X

WHISKY & GRAPS

COLLECTION

SET GRAPS

ART. 0830180N.C71

€ TBC

6 / 12 / 960

V 30 ml

PACK 2X

**SET KAPTIM**

ART. 0830222N.C71

€ TBC

6 / 6 / -

V 25 cl

PACK 2X





BALOONS

ART. 0830212N.C9N

✓ 35 cl

PACK 3X

ASSORTED

€ TBC
6 / 6 / 144



BALOONS

ART. 0830182N

✓ 35 cl

PACK 2X

COLORS   

€ TBC
6 / 6 / 288



OXIGEN

ART. 0830208N.C9N

✓ 30 cl

PACK 4X



€ TBC
6 / 6 / 120



VINTAGE

ART. 0830195N

✓ 30 cl

PACK 4X



€ TBC
6 / 6 / 162



COOL CUBES

ART. 0826005N

PACK 10X

€ TBC
12 / 48 / -



Cubetti ghiaccio riutilizzabili in materiale plastico. Perfetti per raffreddare tutti i tipi di bevande.





Il SAN (Styrol-Acrylnitril) è un materiale plastico rigido e trasparente ad uso alimentare, adatto al lavaggio in lavastoviglie e quindi perfetto all'utilizzo in cucina.

TAHITI

ART. 0830181C.C9N

✓ 20 cl

PACK 4X

€ TBC
6 / 6 / 288

OCTOGLASS COLOR

ART. 0830207N.C9N

✓ 28 cl

PACK 4X

€ TBC
6 / 12 / 240



MULTIGLASS COLOR

ART. 0830192N.C9N

✓ 30 cl

PACK 4X

ASSORTED

€ TBC
6 / 6 / 192

MULTIGLASS COLOR

ART. 0830188N

✓ 30 cl

PACK 2X

COLORS



€ TBC
6 / 6 / 252

WINEGLASS GLAMOUR

ART. 0830184C.C1P

✓ 60 cl

PACK 4X

€ TBC
2 / 6 / 72



REEL



WINEGLASS SAN 20

ART. 0830186N.C30

€ TBC
6 / 24 / 384

✓ 20 cl



OCTOGLASS BLUE

ART. 0830207S.C30

€ TBC
6 / 12 / 504

✓ 28 cl



SET COCKTAIL HIGH

ART. 0830165N.C71

€ TBC
6 / 6 / 56

✓ 40 cl

PACK 2X



SET OCTOGLASS

ART. 0830178N.C71

€ TBC
4 / 4 / 188

✓ 28 cl

PACK 3X



SCRATCH RESISTANT
HIGH IMPACT RESISTANCE
POLYCARBONATE
HIGH QUALITY DRINKWARE
PERFECTLY TRANSPARENT
LIGHTWEIGHT

Il polycarbonato è un materiale trasparente (polimero) che riunisce molte caratteristiche utili di metallo, vetro e materiali sintetici: altissima resistenza agli urti • antigraffio • alta resistenza alla temperatura • ottime caratteristiche ottiche (trasparenza) • autoestinguente.

DIAMOND

ART. 0830204N

€ TBC
6 / 6 / 162

✓ 30 cl

PACK 4X



ONDA & JAZZ WINEGLASS

ART. 0830184C.C9N

 60 cl

PACK 4X

€ TBC
2 / 6 / 72**ONDA**

ART. 0830214N

 30 cl

PACK 4X

€ TBC
6 / 12 / 168**JAZZ**

ART. 0830215N

 30,5 cl

PACK 4X

€ TBC
6 / 12 / 168



POPOTE COLLECTION

ALUMINIUM

NON-STICK

PTFE COATING



PFOA free

Ideati per impedire ai cibi di attaccarsi, naturalmente senza che sia necessaria l'aggiunta di condimenti grassi e quindi per una cottura più sana!
Garantito senza PFOA.



Classic Black

Rivestimento antiaderente a lunga durata. Igienico, affidabile, resistente agli shock termici, alla corrosione e facile da lavare.

Stone Rock

Speciale rivestimento effetto pietra rinforzato con minerali duri, ultrasensibile a graffi ed abrasioni.

Ceramic

Innovativo rivestimento interno in ceramica antiaderente. Ottima resistenza alle alte temperature ed agli sbalzi termici, non sfoglia, lavabile in lavastoviglie.

VACUBLOCK SYSTEM

FUSION MAGNETIC, CAREZZA & PIRATE

Il nuovo sistema Vacublock protegge le vostre pentole e padelle durante il viaggio e celebra la straordinaria creatività del nostro team di sviluppo nella creazione di soluzioni funzionali per veicoli ricreazionali e barche.

- Facile e intuitivo da usare
- Blocca pentole e padelle mentre il veicolo è in movimento
- Elimina le possibilità di graffi della superficie antiaderente
- Elimina i rumori fastidiosi durante la guida



COVERY TRIO
Ø 20 / 18 / 16 CM

ART. 0806107N

€ TBC
6 / 12 / -

220 g

Coperchio universale in vetro con bordo graduato in silicone adatto per pentole e padelle di diversi diametri.

CARATTERISTICHE:

- Lavabile in lavastoviglie
- Foro per la compensazione della pressione
- Maniglia pieghevole salvaspazio
- Compatibile con il sistema VacuBlock

COVERY TRIO
Ø 22 / 20 / 18 CM

ART. 0806108N

€ TBC
6 / 12 / -

300 g

COVERY TRIO
Ø 24 / 22 / 20 CM

ART. 0806109N

€ TBC
6 / 12 / -

380 g



VIDEO

PATENTED



COVERY Ø 24

ART. 0806103N

€ TBC
6 / 12 / -

400 g

Coperchio in vetro con bordo di protezione antirumore in silicone dotato di apertura colapasta e fessura per fissaggio della pinza prendi pentole.

CARATTERISTICHE:

- Bordo in silicone
- Lavabile in lavastoviglie
- Valvola di sfianto
- Maniglia pieghevole salvaspazio



COVERY Ø 22

ART. 0806102N

€ TBC
6 / 12 / -

340 g

COVERY Ø 20

ART. 0806101N

€ TBC
6 / 12 / -

260 g

QUIKPOT

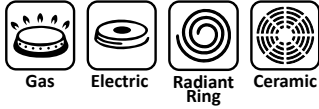

QUIKPOT

ART. 0806091N

€ TBC
2 / 4 / -

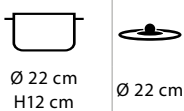

5ℓ



Induction

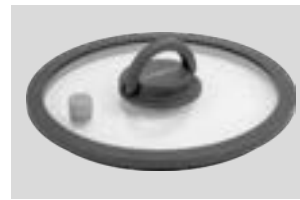
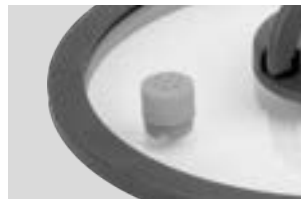

Scoprite la gioia di una cucina nutriente e senza sforzo con la pentola a bassa pressione Quikpot. Questo straordinario prodotto essenziale per la cucina conserva fino al 40% in più di vitamine ed enzimi vitali, assicurando a voi e alla vostra famiglia i massimi benefici per la salute ad ogni pasto. Il design innovativo di Quikpot consente di risparmiare fino al 70% di tempo ed energia, permettendovi di creare piatti deliziosi in una frazione del tempo abituale. Il coperchio trasparente consente di monitorare l'avanzamento del cibo e di aggiungere ingredienti secondo le necessità, mentre il design versatile permette di utilizzarlo anche come pentola o casseruola tradizionale.

CARATTERISTICHE:

- Conserva fino al 40% in più di vitamine ed enzimi
- Risparmio di tempo ed energia fino al 70%
- Il gusto e l'aroma degli alimenti vengono preservati e migliorati
- Può essere utilizzato anche come una normale pentola o casseruola
- Coperchio trasparente per controllare la cottura e aggiungere ingredienti in qualsiasi momento

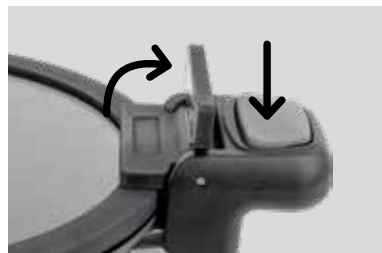



Stone Rock

multiple layer coating

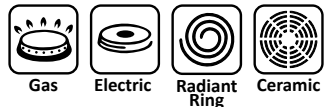

PFOA free



PIRATE

PIRATE 6+1 Ø 18

ART. 0806092N

2,1 kg

€ TBC
4 / 4 / 72

Ø 18 cm 3,3 l	Ø 16 cm 1,6 l	Ø 18 cm 1,3 l	Ø 18 cm	Ø 16 cm	1X	1x



PIRATE 7+1 Ø 20

ART. 0806093N

2,65 kg



€ TBC
4 / 4 / 60

Ø 20 cm 4 l	Ø 20 cm	Ø 16 cm 1,6 l	Ø 20 cm 1,5 l	Ø 18 cm 1 l	Ø 18 cm	1X 1x



PIRATE 7+1 Ø 22

ART. 0806094N

3,18 kg

€ TBC
4 / 4 / 48

Ø 22 cm 5,3 l	Ø 22 cm	Ø 22 cm 1,8 l	Ø 18 cm 2 l	Ø 22 cm	Ø 18 cm	1X 1x



PIRATE 9+1 Ø 24

ART. 0806095N

3,9 kg

€ TBC
4 / 4 / 48

Ø 24 cm 6 l	Ø 22 cm	Ø 20 cm 2,5 l	Ø 16 cm 1,5 l	Ø 24 cm 2,2 l	Ø 20 cm	Ø 24 cm Ø 20 cm 1X 1x



PIRATE PAN 3

ART. 0806089N

1,20 kg



€ TBC
6 / 12 / 120

ø 28 cm



ø 22 cm

PIRATE POT 5

ART. 0806088N

1,90 kg

€ TBC
6 / 12 / 72



ø 24 cm

ø 20 cm

SET MEPO BOX SERENADE

ART. 0806086N.C6A

€ TBC
1 / 2 / -



ø 22 cm 5 l	ø 18 cm 1 l	ø 20 cm 1,7 l	ø 22 cm 2 l	ø 22 cm	ø 18 cm	1X	1X

31 x 54 x H27,5 cm

1x



Melamineware

	4 x ø 21 cm		4 x ø 25 cm
	4 x ø 15 cm		4 x 30 cl

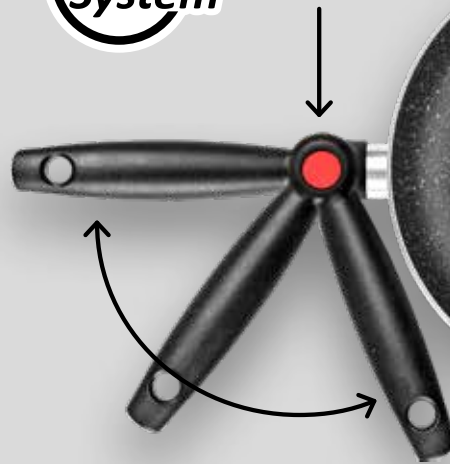

PIRATE PAN 24

ART. 0806098N

0,55 kg

ø 24 cm

€ TBC
5 / 15 / 240



PIRATE PAN 26

ART. 0806097N

0,62 kg

ø 26 cm

€ TBC
5 / 15 / 240



PIRATE WOK

ART. 0806096N

0,75 kg

ø 28 cm

€ TBC
6 / 12 / 192



PIRATE SQUARE GRILL

ART. 0806099N

0,94 kg

28 x 28 cm

€ TBC
4 / 12 / 156





PIRATE NG 7+1 Ø 20

ART. 0806083N

3,40 kg

€ TBC
4 / 4 / 72



Ø 20 cm 4 l	Ø 20 cm 1,5 l	Ø 18 cm 1,3 l	Ø 16 cm 1,6 l	Ø 20 cm	Ø 20 / 18 / 16 cm	1x	1x

PIRATE NG 7+1 Ø 22

ART. 0806084N

3,70 kg

€ TBC
4 / 4 / 48



Ø 22 cm 5,3 l	Ø 22 cm 2 l	Ø 20 cm 1,7 l	Ø 18 cm 1 l	Ø 22 cm	Ø 22 / 20 / 18 cm	1x	1x

PIRATE NG 7+1 Ø 24

ART. 0806085N

4,32 kg

€ TBC
4 / 4 / 48



Ø 24 cm 6 l	Ø 24 cm 2,2 l	Ø 22 cm 1,8 l	Ø 20 cm 3 l	Ø 24 cm	Ø 24 / 22 / 20 cm	1x	1x

PIRATE NG



100%
RECYCLED
ALUMINIUM

VACUBLOCK
System



H 20 cm



SPACEMASTER

Stone
Rock

multiple
layer
coating



Gas

Electric

Induction

Ceramic

SPACEMASTER



H 15 cm



PIRATE SPACEMASTER Ø 20 MINI

ART. 0806087N

€ TBC
4 / 4 / 72



Ø 20 cm H 9 cm	Ø 18 cm H 8 cm	Ø 20 cm H 5 cm	Ø 20 cm	1X



PIRATE SPACEMASTER Ø 22

ART. 0806064N

€ TBC
4 / 4 / 72



Ø 22 cm H 10 cm	Ø 18 cm H 9 cm	Ø 22 cm H 5 cm	Ø 22 cm	1X



PIRATE SPACEMASTER Ø 24

ART. 0806063N

€ TBC
4 / 4 / 48



Ø 24 cm H 10 cm	Ø 20 cm H 9 cm	Ø 24 cm H 5 cm	Ø 24 cm	2X



PIRATE SPACEMASTER Ø 26

ART. 0806061N

€ TBC
4 / 4 / 40

Ø 26 cm H 5 cm	Ø 22 cm H 10 cm	Ø 18 cm H 9 cm	Ø 22 cm	2X

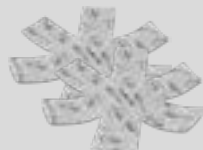



100%
RECYCLED
ALUMINIUM



CAREZZA

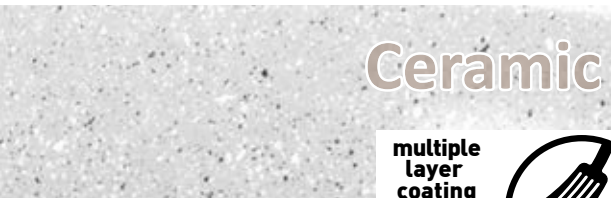

Ceramic

multiple
layer
coating

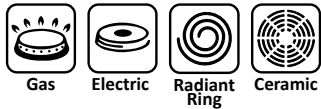

Induction



PFOAfree



VIDEO

SPACEMASTER

CAREZZA 7+1 Ø 22

ART. 0804082N

€ TBC
4 / 4 / 40

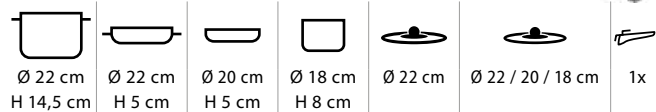

360°



CAREZZA SPACEMASTER Ø 22 VACUBLOCK

ART. 0804081N

€ TBC
4 / 4 / 56



CAREZZA SPACEMASTER Ø 20 VACUBLOCK

ART. 0804080N

€ TBC
4 / 4 / 40



PATENTED

VACUBLOCK System



CAREZZA MAGNETOGRIP

Maniglia con sistema di connessione di nuova concezione che, attraverso l'uso di impugnature pieghevoli con elementi magnetici integrati, consente di ridurre notevolmente le dimensioni dell'imballaggio dei set di pentole e rende inoltre superfluo l'uso di una cinghia di fissaggio per stabilizzare la pentola e la padella durante il trasporto.

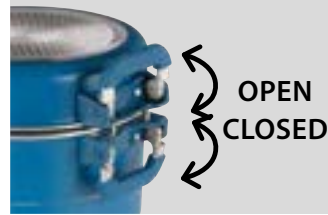

100% RECYCLED ALUMINIUM



CAREZZA PAN 24

ART. 0804084N

∅ 24 cm

CAREZZA PAN 26

ART. 0804085N

∅ 26 cm

CAREZZA MAGNETOGRIP 7+1 Ø 20

ART. 0804091N

€ TBC
4 / 4 / 72



∅ 20 cm 4 l	∅ 20 cm 1 l	∅ 18 cm 1 l	∅ 16 cm 1,4 l	∅ 20 cm	∅ 20 / 18 / 16 cm	1x

CAREZZA MAGNETOGRIP 7+1 Ø 22

ART. 0804092N



∅ 22 cm 4 l	∅ 22 cm 1,5 l	∅ 20 cm 1,5 l	∅ 18 cm 2 l	∅ 22 cm	∅ 22 / 20 / 18 cm	1x

CAREZZA MAGNETOGRIP 7+1 Ø 24

ART. 0804093N

€ TBC
4 / 4 / 40



∅ 24 cm 4,1 l	∅ 24 cm 1,4 l	∅ 22 cm 1,4 l	∅ 20 cm 2,3 l	∅ 24 cm	∅ 24 / 22 / 20 cm	1x



Ceramic

multiple layer coating

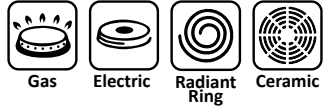

FUSION

MAGNETIC



FUSION 7+1 Ø 22

ART. 0806050N

€ TBC
4 / 4 / 40



VACUBLOCK System



Ø 22 cm 4,9l	Ø 22 cm 1,5l	Ø 20 cm 1,2l	Ø 18 cm 1,7l	Ø 22 cm	Ø 22 / 20 / 18 cm	1x



MAGNETOGRIP SYSTEM

Maniglia con sistema di connessione di nuova concezione che, attraverso l'uso di impugnature pieghevoli con elementi magnetici integrati, consente di ridurre notevolmente le dimensioni dell'imballaggio dei set di pentole e rende inoltre superfluo l'uso di una cinghia di fissaggio per stabilizzare la pentola e la padella durante il trasporto.

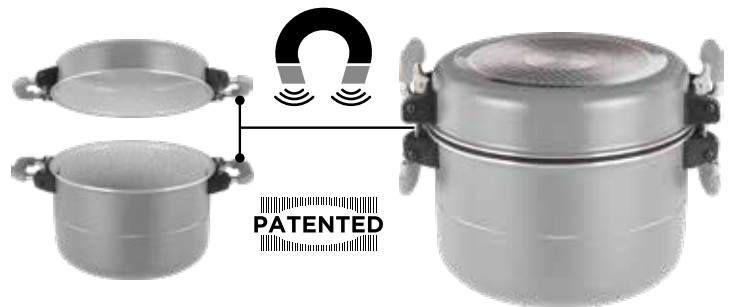
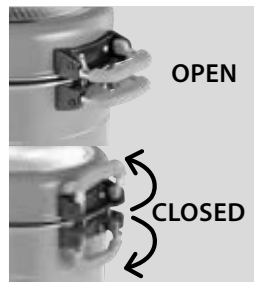

Ceramic

multiple layer coating

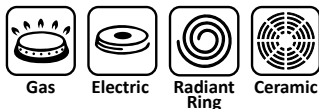

La popote Torralta è la soluzione definitiva per i proprietari di camper e barche alla ricerca di pentole efficienti. Questa collezione è stata sviluppata per cucine compatte e offre un rapporto ottimale tra superficie e volume per gestire maggiori quantità di cibo. Grazie allo speciale design dei bordi, le padelle incluse si appoggiano saldamente senza il rischio di scivolare. Tutte le pentole e le padelle sono realizzate con lattine di alluminio riciclato. La pentola/padella esterna è dotata di manici pieghevoli per essere riposta in modo compatto e salvaspazio. Questo versatile set è compatibile con tutti i tipi di piano cottura, compreso quello a induzione, ed è disponibile in tre combinazioni di dimensioni. È incluso un manico rimovibile per le pentole interne.

PATENTED VACUBLOCK System

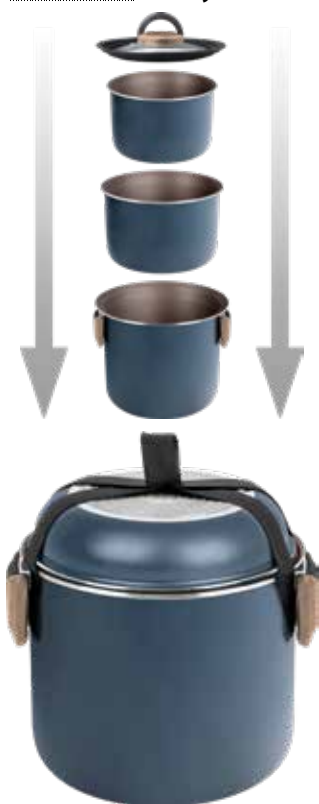

CARATTERISTICHE:

- Rapporto ottimale tra superficie di base e volume delle pentole
- Design speciale dei bordi per una presa sicura delle pentole
- Realizzato in alluminio riciclato
- Adatto a tutti i tipi di piano cottura (anche a induzione)
- Manici pieghevoli e salvaspazio per le pentole e le padelle esterne
- Disponibile in tre misure



100% RECYCLED ALUMINIUM

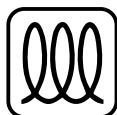

Induction

TORRALTA



TORRALTA Ø 18

ART. 0806056N



€ TBC
4 / 4 / -

Ø 18 cm H 18 cm	Ø 18 cm H 5 cm	Ø 16 cm H 11 cm	Ø 14 cm H 10 cm	Ø 18 / 16 / 14 cm	1x

TORRALTA Ø 20

ART. 0806057N



€ TBC
4 / 4 / -

Ø 20 cm H 19 cm	Ø 20 cm H 5 cm	Ø 18 cm H 13 cm	Ø 16 cm H 11 cm	Ø 11 cm H 11,5 cm	Ø 20 cm	Ø 20 / 18 / 16 cm	2x

TORRALTA Ø 22

ART. 0806058N



€ TBC
4 / 4 / -

Ø 22 cm H 20 cm	Ø 22 cm H 5 cm	Ø 20 cm H 15 cm	Ø 18 cm H 13 cm	Ø 11 cm H 11,5 cm	Ø 22 cm	Ø 22 / 20 / 18 cm	2x

TORRALTA MILK

ART. 0806045N

€ TBC
6 / 12 / -

Ø 11 cm x H 11,5 cm



Bollilatte in alluminio con manico termoisolante. Corpo robusto con rivestimento interno antiaderente. Ideale per riscaldare e bollire il latte. Lavabile in lavastoviglie.

CHOCOLATE

Ceramic



PFOAfree



multiple layer coating



Gas

Electric

Radiant Ring

Ceramic



CHOCOLATE 7+1 Ø 20

ART. 0804041N

2,75 kg

€ TBC
4 / 4 / 60



Ø 20 cm	Ø 16 cm	Ø 14 cm	Ø 20 cm	Ø 20 cm	Ø 16 cm	1x	1x
4 l	1,6 l	1 l	1,5 l				

CHOCOLATE 9+1 Ø 22

ART. 0804042N

3,70 kg

€ TBC
4 / 4 / 40



Ø 22 cm	Ø 22 cm	Ø 18 cm	Ø 14 cm	Ø 22 cm	Ø 20 cm	Ø 22 cm	Ø 18 cm	1x	1x
5,3 l		2 l	1 l	1,8 l	1,5 l				

COOKING SET

ART. 0832021N

€ TBC
6 / 24 / 192



Set posate cucina composto da 6 pezzi. Realizzato in nylon alimentare.

TOASTER

ART. 0706019N

€ TBC
10 / 40 / 480



Ø 22 cm
150 g

Griglia tostapane pieghevole per fornelli a gas. Con piastra in acciaio.

POTGUARD

ART. 0806079N

€ TBC
12 / 24 / -



Ø 20 / 22 / 24 cm

Protezione per pentole e padelle realizzata in feltro di poliestere. Ideale per prevenire graffi e altri danni causati da impilaggio, stoccaggio o rimozione. Fornita in set da 3 pezzi (20-22-24 cm).

THERMATE

ART. 0708049N

€ TBC
6 / 12 / -



Ø 16 cm
200 g

Piastra di cottura in acciaio per fornelli a gas.



GOURMET ROCK

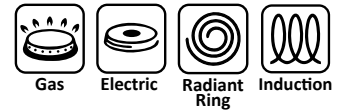

GOURMET ROCK SQUARE PAN 28

ART. 0806073N

0,80 kg

28 x 28 cm

€ TBC
4 / 12 / 240

GOURMET ROCK SQUARE PAN 26

ART. 0806072N

0,75 kg

26 x 26 cm

€ TBC
4 / 12 / 192



Push System



GOURMET ROCK NG 8+1 Ø 20

ART. 0806080N

3,45 kg

€ TBC
4 / 4 / 56



Ø 20 cm	Ø 18 cm	Ø 16 cm	Ø 18 cm	Ø 20 cm	Ø 20 cm	Ø 18 cm	1x	1x
4 l	1,6 l	1 l	1,3 l	1,5 l				



GOURMET ROCK NG 9+1 Ø 22

ART. 0806081N

4,10 kg

€ TBC
4 / 4 / 56



Ø 22 cm	Ø 22 cm	Ø 18 cm	Ø 16 cm	Ø 22 cm	Ø 18 cm	Ø 22 cm	Ø 18 cm	1x	1x
5,3 l		2,5 l	1 l	1,8 l	1,5 l				



Classic
Black



Gas



Electric



Radiant
Ring



Ceramic



NON-STICK
SURFACE



SILICONE SOFT TOUCH



CLAMP SYSTEM

SKIPPER



PFOAfree

SKIPPER 7+1 Ø 18

ART. 0806006N

2,5 kg

€ TBC
4 / 4 / 72



Ø 18 cm
3,3l



Ø 16 cm
1,6l



Ø 14 cm
1l



Ø 18 cm
1l



Ø 18 cm



Ø 16 cm



1 x



1 x

SKIPPER 8+1 Ø 20

ART. 0806007N

3,08 kg

€ TBC
4 / 4 / 40



Ø 20 cm
4l



Ø 18 cm
1,6l



Ø 14 cm
1l



Ø 18 cm
1,3l



Ø 20 cm



Ø 18 cm



1 x



1 x

SKIPPER 4+1 Ø 22

ART. 0806008N

1,65 kg

€ TBC
4 / 4 / 40



Ø 22 cm
5l



Ø 22 cm



Ø 22 cm
2l



Ø 22 cm



1 x



SKIPPER PAN

Pentola alluminio con fondo antiaderente. Con manico staccabile.



SOFT TOUCH



SKIPPER WOK

ART. 0806039N

520 g

ø 28 cm

€ TBC
6 / 12 / 180



Padella Wok di alluminio con fondo antiaderente. Con manico staccabile.



SKIPPER PAN Ø 20

ART. 0806040N

320 g

€ TBC
5 / 15 / 450



ø 20 cm - 1 l

SKIPPER PAN Ø 22

ART. 0806041N

380 g

€ TBC
5 / 15 / 540



ø 22 cm - 1,8 l

SKIPPER PAN Ø 26

ART. 0806042N

450 g

€ TBC
5 / 15 / 480



ø 26 cm - 2,1 l

SKIPPER 4

ART. 0806037N

750 gr

€ TBC
5 / 10 / 140



ø 20 cm - 1 l



ø 26 cm - 2,1 l

SKIPPER 6

ART. 0806038N

1 kg

€ TBC
6 / 12 / 72



ø 16 cm - 1,6 l

ø 16 cm

ø 20 cm - 2,6 l

ø 20 cm

Set 4 pezzi di padelle in alluminio con fondo antiaderente e manici staccabili.

Set 6 pezzi di casseruole e coperchi in acciaio con fondo antiaderente e manici staccabili.



Classic Black



Gas



Electric



Radiant Ring



Ceramic



NON-STICK SURFACE



PFOA free

JUNIPER NG



JUNIPER PAN

ART. 0806065N.C34

700 gr

€ TBC
4 / 12 / 240



Padella in alluminio con rivestimento antiaderente di ottima qualità. Dotata di praticissimo manico pieghevole salvaspazio brevettato.



JUNIPER NG 7+1 Ø 20

ART. 0806075N.C34

3 kg

€ TBC
4 / 4 / 96

Ø 20 cm 4 l	Ø 16 cm 1,6 l	Ø 14 cm 1 l	Ø 20 cm 1,5 l	Ø 20 cm	Ø 16 cm	1X	1X



JUNIPER NG 8+1 Ø 22

ART. 0806060N.C34

3,5 kg

€ TBC
4 / 4 / 64

Ø 22 cm 5,3 l	Ø 20 cm 2,5 l	Ø 14 cm 1 l	Ø 22 cm 1,8 l	Ø 22 cm	Ø 22 cm	Ø 20 cm	1X	1X



JUNIPER NG 8+1 Ø 24

ART. 0806067N.C34

3,94 kg

€ TBC
4 / 4 / 48

Ø 24 cm 6 l	Ø 20 cm 3 l	Ø 16 cm 1,5 l	Ø 24 cm 2,2 l	Ø 22 cm	Ø 24 cm	Ø 20 cm	1X	1X



Classic
Black

Gas



Electric

Radiant
Ring

Ceramic

FLAVOR



PFOA free

Realizzato in alluminio resistente e dotato di un innovativo rivestimento antiaderente, questo pratico set di pentole è il compagno perfetto per le vostre avventure culinarie. Il suo design impilabile consente di risparmiare prezioso spazio, mentre l'intelligente composizione offre numerose possibilità di cottura. Manici in silicone. Disponibile in 2 versioni.



FLAVOR 7+1 Ø 20

ART. 0806076N

€ TBC
4 / 4 / 48Ø 20 cm
4 lØ 16 cm
1,6 lØ 20 cm
1,5 lØ 18 cm
1 l

Ø 20 cm



Ø 18 cm



1X



1x



FLAVOR 7+1 Ø 22

ART. 0806078N

€ TBC
4 / 4 / 48Ø 22 cm
5,3 lØ 22 cm
1,8 lØ 20 cm
2,5 lØ 16 cm
1,5 l

Ø 22 cm



Ø 20 cm



1X



1x



BITER

ART. 0832027C

€ TBC
6 / 24 / -

110 g



Praticissima pinza prendi pentola con meccanismo di sicurezza contro l'apertura accidentale. Applicazione fissa a pentole e padelle. Esecuzione stabile e robusta.

TAKER

ART. 0832000C

€ TBC
12 / 12 / -

70 g



Pinza prendi pentole universale in materiale termoplastico per pentole e padelle.





INOX

Stainless Steel

Acciaio inox: Durevole e resistente agli urti. Resiste a graffi e ammaccature, rimanendo bello anche dopo anni di utilizzo. Ottimo conduttore termico: distribuisce il calore uniformemente. Igienico, facile da pulire e mantenere brillante.

ACADEMY PAN Ø 22

ART. 0804034N



ACADEMY MINI

ART. 0804030N

€ TBC
4 / 4 / 72

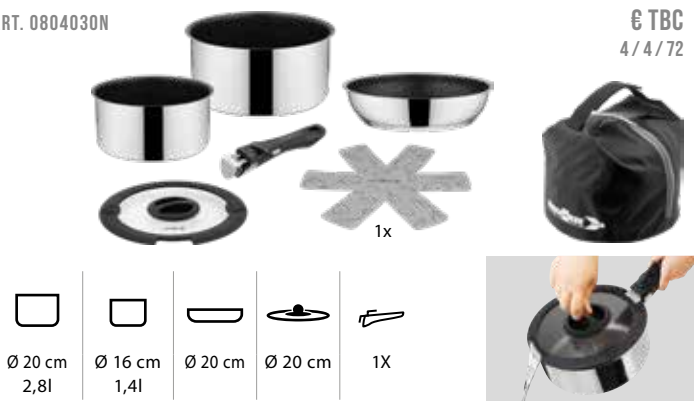

ACADEMY DOUBLE PAN Ø 22/20

€ TBC
4 / 4 / 144

ART. 0804036N

€ TBC
4 / 4 / 144



ACADEMY NG

INOX



PFOAfree

multiple layer coating



PFLUON



ACADEMY NG 5+1 Ø 20

ART. 0804031N



H 12,7 cm

1x

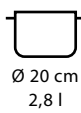

Ø 20 cm
2,8 l

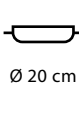

Ø 20 cm



Ø 16 cm
1,4 l

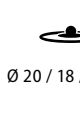

Ø 20 / 18 / 16 cm



1x



1x

€ TBC
4 / 4 / 72

ACADEMY VACUM 5+1 Ø 22

ART. 0804035N



H 13,7 cm

1x

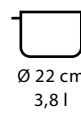

Ø 22 cm
3,8 l

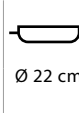

Ø 22 cm

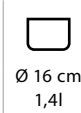

Ø 16 cm
1,4 l

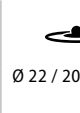

Ø 22 / 20 / 18 cm



1x



1x

€ TBC
4 / 4 / -

Functional
Cooking Lids



VACUBLOCK
System

PATENTED



induction
sandwich
bottom



ACADEMY HIGH NG 7+1 Ø 22

ART. 0804033N



H 18,7 cm

2x



Ø 22 cm
5,2 l

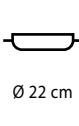

Ø 22 cm



Ø 20 cm



Ø 18 cm
2,2 l



Ø 22 cm

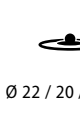

Ø 22 / 20 / 18 cm

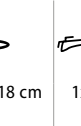

1x

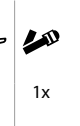

1x

€ TBC
4 / 4 / 48

ACADEMY NG 7+1 Ø 22

ART. 0804032N



H 15,7 cm

2x

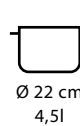

Ø 22 cm
4,5 l

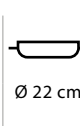

Ø 22 cm



Ø 18 cm



Ø 16 cm
1,4 l



Ø 22 cm

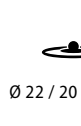

Ø 22 / 20 / 18 cm

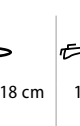

1x



1x

€ TBC
4 / 4 / 72

ACADEMY COMPACT

INOX

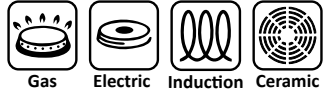

INOX

Stainless Steel



ACADEMY COMPACT Ø 20

ART. 0804020N

€ TBC
4 / 4 / 144

ACADEMY COMPACT Ø 22

ART. 0804021N

€ TBC
4 / 4 / 96



Ø 20 cm
H12 cm



Ø 20 cm



Ø 22 cm
H12 cm



Ø 22 cm



OMNIBOX

INOX



INOX
Stainless Steel

OMNIBOX 18+2 Ø 22

ART. 0804028N.C06

4,25 kg

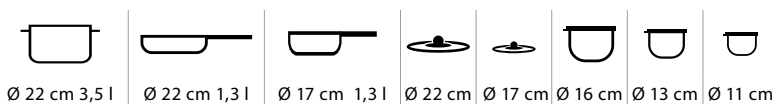
 € TBC
2 / 2 / 40

WITH COLANDER OPENING

Set cucina 18+2 con tutto il necessario per equipaggiare la cucina mobile.

SONO COMPRESI I SEGUENTI PEZZI:

- Pentola in acciaio inox con manici silicone Ø 22 cm - 3,5 litri • Coperchio Ø 22 cm in vetro con pomolo in silicone • Casseruola in acciaio inox Ø 17 cm - 1,3 litri con manico in silicone • Coperchio Ø 17 cm in vetro con pomolo in silicone • Contenitore in plastica Ø 16 cm con coperchio • Contenitore in plastica Ø 13 cm con coperchio • Contenitore in plastica Ø 11 cm con coperchio • Padella in acciaio inox Ø 23 cm - 1,5 litri con manico in silicone • Cucchiaino • Paletta • Mestolo • Cucchiaino forato • Pelapatate • Grattugia • Forbice • Coltello • Spazzolino lava piatti • Panno per pulire/asciugare • Borsa per stivaggio • Borsa per il trasporto





Gas



Electric



Halogen



Freezer

Inox
Stainless Steel

VOLCANO

INOX

FOLD-AWAY



VOLCANO FOLD-AWAY

Ø 24

ART. 0804026N

Ø 24 x 4,5/14,5 cm

€ TBC

4 / 12 / 288

VOLCANO FOLD-AWAY

Ø 20

ART. 0804027N

Ø 20 x 3,5/8,5 cm

€ TBC

4 / 12 / 288



Pentole collapsabili per fornelli (gas ed elettrici).

CARATTERISTICHE:

- Pentole realizzate in silicone di alta qualità ed acciaio inox
- Coperchio in vetro con bordo antiscivolo
- Maniglie in metallo con rivestimento in silicone

VOLCANO PAN FOLD-AWAY

ART. 0804024N

Ø 24 cm

€ TBC

4 / 12 / 360



FOLD-AWAY



VOLCANO PASTA AL VOLO

ART. 0804029N

€ TBC

4 / 4 / 160

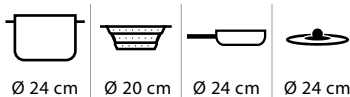

9 CM





PACKPOT ULTRALITE 18

ART. 0802024N

€ TBC

4 / 16 / 192

PACKPOT ULTRALITE 20

ART. 0802026N

€ TBC

4 / 12 / 192



672 g



PFOA free

Anodised ultralight



870 g



PFOA free

Anodised ultralight



Set popote Outdoor in alluminio anodizzato per 3/4 persone.

MANICI PIEGHEVOLI RIVESTITI IN SILICONE TERMOISOLANTE. IL SET È COMPOSTO DA:

- 1 pentolino con coperchio Ø 16,6 x 8,9 cm
- 1 padella Ø 16,7 x 4,4 cm
- 1 bollitore Ø 14,6 x 8,3 cm (1,1l)
- 1 mestolo in bambù
- sacchetto custodia

Set popote Outdoor in alluminio anodizzato per 4/5 persone.

MANICI PIEGHEVOLI RIVESTITI IN SILICONE TERMOISOLANTE. IL SET È COMPOSTO DA:

- 1 pentolino grande con coperchio Ø 19 x 11,2 cm
- 1 pentolino piccolo con coperchio Ø 16,6 x 8,9 cm
- 1 padella Ø 19,5 x 4,5 cm
- 1 mestolo in legno
- sacchetto custodia

FOLD-AWAY COLANDER

ART. 0832210N.C06

€ TBC

6 / 24 / 384

RIDER

ART. 0830413N

€ TBC

12 / 72 / -

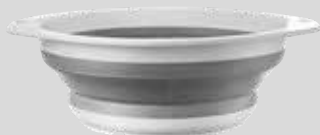

Ø 22 x 3,5/11 cm

220 g

FOLD-AWAY



Scolapasta colassabile. Prodotto in PP-TPR facile da pulire, resistente al calore e pieghevole.



1,5 x 1,5 x 4,8 cm

PCS. 2

COLORS C30 C34

Portamestolo in silicone.



DAYO

ART. 0802017N



✓ 1,8l

Ø 18 x H14,5 / 21 cm

420 g



Elegante bollitore realizzato in acciaio inox.



€ TBC
6 / 12 / 192

DAYO BLACK NG

ART. 0802018N



✓ 1,8l

Ø 18 x H14,5 / 21 cm

420 g



Bollitore per l'acqua di costruzione identica al modello Dayo, ma dotato di fondo all'induzione e di manici in gomma antiscivolo. Design elegante.



€ TBC
6 / 12 / 144



KETTY

ART. 0802012N



✓ 1l

Ø 15 x H14 cm

150 g



Bollitore acqua in resistente alluminio. Dotato di manico removibile in plastica.



€ TBC
6 / 36 / -

AMIGO 2

ART. 0830018N

€ TBC
50 / 200 / -

1-2 Cups / 7,5 cm

AMIGO 4

ART. 0830019N

€ TBC
10 / 200 / -

2-4 Cups / 9 cm

AMIGO



Filtro per caffè in acciaio inox estremamente leggero, pieghevole e facile da montare grazie ai suoi morsetti laterali metallici flessibili.

OUTDOOR LIFESTYLE



MC MOKA 3

ART. 0804078N

Ø 10 x 14,5 x H15 cm

316 g



MC MOKA 6

ART. 0804079N

Ø 12 x 17 x H20 cm

476 g



La caffettiera a induzione McMoka nasce dalla continua ricerca di nuove soluzioni, adatte ai cambiamenti e alla evoluzione dei gusti e delle abitudini dell'universo outdoor. Realizzata interamente in alluminio con fondo in acciaio, rappresenta la storica moka a cui non sappiamo rinunciare, ma con il vantaggio di una base molto ampia e di poter essere utilizzata su qualunque piano di cottura. Disponibile in 2 versioni, da 3 e da 6 persone.



INOX
Stainless Steel





GAS ITEMS

**FORNELLI E GRILL
ACCESSORI GAS**

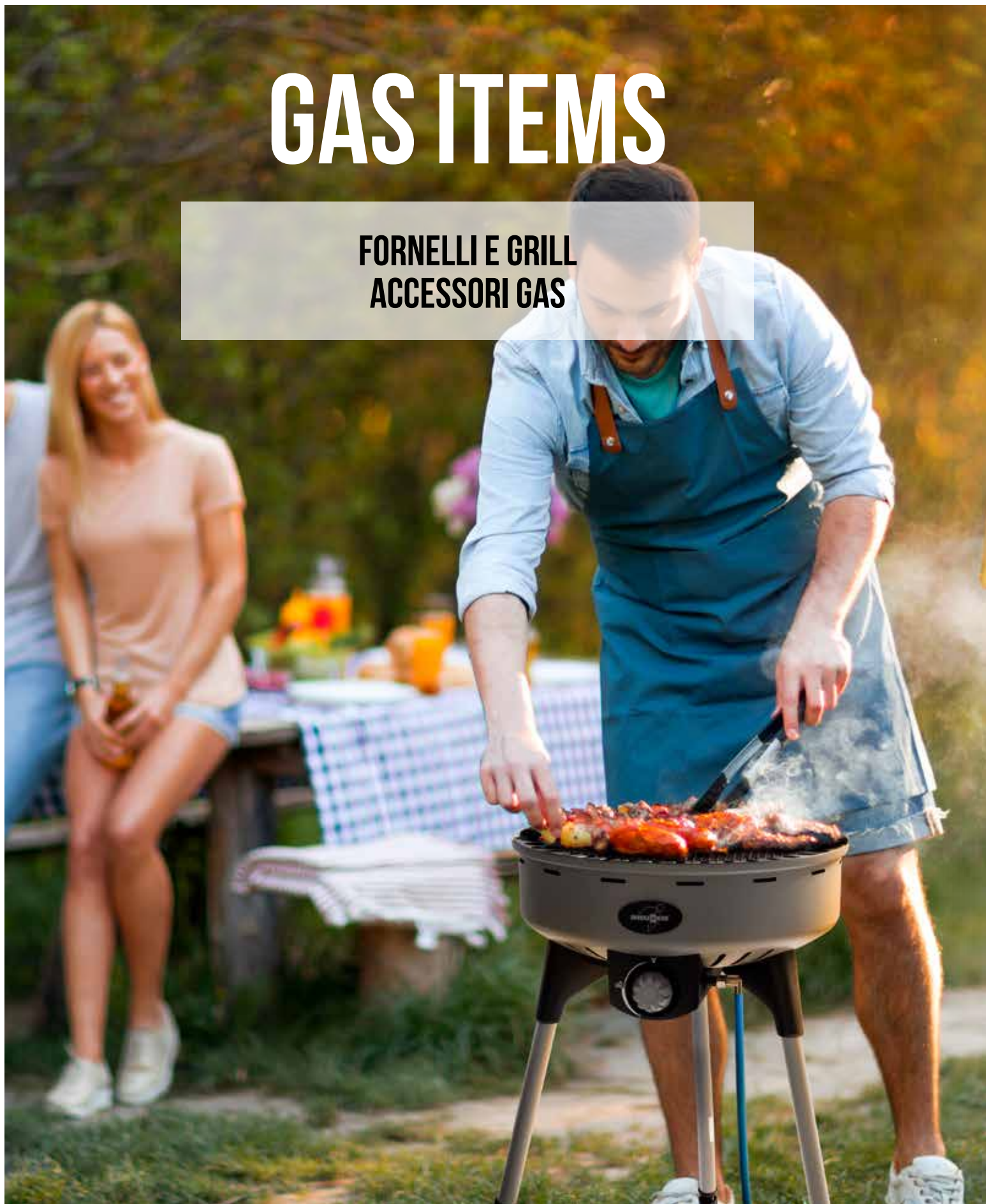

MARIPOSA

FOLDABLE GAS GRILL

INFO P. 297



CUCINARE CON IL GAS



Cucinare con il gas all'aperto è di norma semplice, facile e pulito. Ci sono comunque alcune importanti regole da non dimenticare:

- E' vietato introdurre bombolette gas negli aerei
- Verificare che a destinazione siano acquistabili delle bombolette gas adatte
- Con l'aumentare dell'altezza sul livello del mare, diminuisce l'efficienza dei fornelli a gas
- Anche temperature sotto zero riducono la capacità di apparecchi a gas
- Usare sempre un paravento
- Durante la cottura usare possibilmente sempre un coperchio, per evitare che il calore si disperda

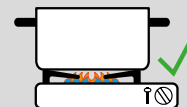
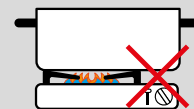





DEVIL

ART. 0708013N

€ TBC
3/3/72

 37,2 x 28,6 x 12,5 cm

 2,2 kW

 2 kg



GAS

INOX
Stainless Steel

Fornello a gas pratico e compatto che funziona con cartucce di gas a valvola MSF-1A. Compatto e potente, tuttavia molto facile da usare. Grazie all'accensione piezoelettrica integrata, la cottura si avvia in pochi secondi senza bisogno di accendini o fiammiferi. Il bruciatore regolabile ad alte prestazioni consente una preparazione precisa dei cibi e il calore può essere facilmente regolato in base alle esigenze culinarie. Adatto a tutte le attività all'aperto.

CARATTERISTICHE:

- In acciaio inossidabile
- Griglia di appoggio smaltata nera garantisce stabilità di pentole o padelle da 12 a 26 cm di diam.
- Alta potenza di calore 2,2 kW e consumo max. di gas 160g/h
- Dispone di fori di raffreddamento ad aria
- Completo di paravento per garantire la massima efficienza e prestazioni
- Completo di pratica valigetta in plastica per un facile trasporto



DEVIL PLANCHA FLAT

ART. 0708027N

€ TBC
4/4/-

 25,5 x 24,4 x 2,2 cm

 620 g



Piastra grill di alta qualità con una superficie liscia antiaderente e un fondo appositamente progettato, che garantisce una buona tenuta su tutte le stufe a gas Devil a cartuccia.



DEVIL PLANCHA RIBBED

ART. 0708029N

€ TBC
4/4/-

 25,5 x 24,4 x 2,2 cm

 620 g



Piastra grill di alta qualità con una superficie rigata antiaderente e un fondo appositamente progettato, che garantisce una buona tenuta su tutte le stufe a gas Devil a cartuccia.

DEVIL

COLLECTION



DEVIL SD NG

ART. 0708043N

€ TBC
3 / 3 / 90SAFETY DEVICE
THERMOCOUPLE
 37,2 x 28,6 x 12,5 cm

 2,2 kW

 2 kg

INOX
Stainless Steel

La versione del fornello Devil SD NG ha un design più moderno del modello precedente con alcune caratteristiche migliorative.

CARATTERISTICHE:

- Dispositivo di sicurezza di accensione integrato con termocoppia, montato sul bruciatore, che controlla una valvola che interrompe automaticamente l'alimentazione del gas al bruciatore in caso di spegnimento della fiamma, ad esempio a causa di vento o liquidi.
- La griglia portapentole ed il coperchio del vano cartucce sono realizzati in acciaio inox lucidato e resistente.



DEVIL SQUARE PAN

ART. 0708026N

€ TBC
4 / 4 / 180
 24 x 22 x H6,7 cm

 700 g

Casseruola quadrata in alluminio con rivestimento antiaderente, maniglie integrate e pratico coperchio in vetro. Il fondo appositamente progettato garantisce una tenuta sicura su tutti i fornelli a cartuccia a gas della linea Devil. Costruzione di alta qualità con bordi sagomati che impediscono la deformazione causata dal calore.



DEVIL GRILL PLATE

ART. 0708019N

€ TBC
12 / 12 / 144
 Ø 31 cm

 400 g

Piastra grill a gas portatile con vaschetta di raccolta del grasso sotto la piastra. Con rivestimento antiaderente per una cottura uniforme di pesce, carne e verdure. Un sollevatore di piastra completo di apribottiglie consente di sollevare la piastra in modo sicuro.



Inox
Stainless Steel





**GRILL PLATE
INCLUDED**

DEVIL DOUBLE GRILL

ART. 0708017N

 67,9 x 28,6 x H12,5 cm + Plate 53 x 28 x H2,6 cm

 2x 2,2 kW

 7,1 kg

€ TBC
2 / 2 / 40

Fornello a doppio gas con due fuochi e con piastra grill, ideale per preparare diversi cibi contemporaneamente ovunque all'aperto.

CARATTERISTICHE:

- Accensione piezoelettrica integrata
- Piano di cottura e supporti per pentole in acciaio inox
- Piastra grill in alluminio pressofuso con superficie antiaderente liscia e rigata
- Spazio per 2 cartucce di gas
- Due potenti bruciatori da 2,2 kW con un consumo massimo di gas di 160 g/h per bruciatore
- Manopola girevole per un controllo preciso della fiamma





DEVIL DOUBLE SD

ART. 0708044N

€ TBC
2 / 2 / 40

- P** 30 mbar
- 67,9 x 28,6 x H12,5 cm
- P** 2x 2,2 kW
- 6,8 kg

Il fornello a cartuccia Devil Double SD a 2 fuochi è il compagno di cucina Outdoor per eccellenza. Realizzato con precisione, questo modello vanta bruciatori potenti e un resistente alloggiamento in metallo verniciato a polvere. I supporti per pentole in acciaio inox con deflettore per il vento garantiscono prestazioni costanti anche in condizioni difficili. Dettagli importanti come i coperchi del vano cartuccia in acciaio inox e le due manopole di controllo garantiscono un funzionamento senza sforzo. La sicurezza è fondamentale: entrambi i bruciatori sono dotati di un affidabile dispositivo di arresto della fiamma. Per un comodo trasporto, è inclusa una robusta valigetta.

CARATTERISTICHE:

- Alloggiamento in metallo verniciato a polvere
- Supporti per pentole in acciaio inox con deflettore per il vento
- Coperchi del vano cartucce in acciaio inox
- 2 manopole di controllo
- Entrambi i bruciatori con termocoppia
- Con valigetta di trasporto in materiale plastico



ANTI-STICK COATING



DEVIL MEGAGRILL

ART. 0708042N

€ TBC
1 / 1 / 30

- 46 x 34,5 x 10 cm
- P** 2,2 kW
- 4,9 kg

Il Devil Megagrill è ideale come griglia mobile da tavolo per il campeggio o i picnic, ma può essere perfettamente utilizzato anche a casa su balconi o terrazze. Un barbecue molto versatile: combina la cottura mista con la sua superficie a metà grill/metà piastra e con una casseruola/pentola con coperchio per arrostitire e stufare.

CARATTERISTICHE:

- Corpo realizzato in metallo verniciato
- Regolazione individuale della fiamma
- Doppio bruciatore a tubo di alta potenza
- Accensione piezoelettrica integrata
- Funzionamento con cartucce a gas da 227g



DEVIL 450

ART. 0708014N

€ TBC
5 / 5 / 85



35,5 x 22,6 x H23 cm

30,5 x 22,6 x H12 cm

2,4 kW

1,85 kg

Fornello super compatto e perfetto per cucinare, facile da chiudere e trasportare avendo le pratiche gambe pieghevoli. Ideale per le vacanze o semplici gite.

CARATTERISTICHE:

- Accensione piezoelettrica integrata
- Griglia di appoggio in acciaio inox che garantisce stabilità di pentole o padelle da 12 a 26 cm di diam.
- Alta potenza di calore 2,4 kW e consumo max. di gas 175g/h
- Manopola di sicurezza a doppio movimento
- Valvola/ regolatore per mantenere stabile la fiamma
- Completo di pratica valigetta in plastica per un facile trasporto



POWERGAZ 227

ART. 0708021N

€ TBC
4 / 28 / 1008

227 g

POWERGAZ 450

ART. 0708036N

€ TBC
4 / 12 / 480

450 g

Bombolette gas butano/propano valvolate. Conforme alla normativa UN 2037.



VALVE CARTRIDGE



SCREW-IN CARTRIDGE WITH VALVE

MARIPOSA



MARIPOSA 30

ART. 0708032N

€ TBC
1/2/-

P	30 mbar
L	82,5 x 31,0 x 21,7 cm
L	15,2 x 30,0 x 17,0 cm
P	1,5kW
L	7 kg

MARIPOSA 50

ART. 0708033N

€ TBC
1/2/-

P	50 mbar
L	82,5 x 31,0 x 21,7 cm
L	15,2 x 30,0 x 17,0 cm
P	1,5kW
L	7 kg

Realizzato con un'attenzione meticolosa ai dettagli, questo leggero grill a gas è progettato per accompagnarvi in tutte le vostre avventure all'aperto. Con un peso di soli 7 kg, la struttura in alluminio del Mariposa lo rende facile da trasportare, sia che siate diretti alla spiaggia, al parco o al campeggio. Grazie a un semplice processo di installazione, questo grill può essere acceso e pronto a sfrigolare in pochissimo tempo. Basta aprirlo, collegarlo a una bombola di gas standard e il gioco è fatto. Ma il Mariposa non è solo portabilità: è anche un maestro delle prestazioni. Grazie a due zone di temperatura distinte, è possibile controllare con precisione il calore su ciascun lato, consentendo di scottare, grigliare e affumicare alla perfezione. Grazie al design studiato per facilitare la pulizia, potrete godervi le vostre creazioni culinarie senza il fastidio di dover ripulire dopo il pasto.





DEVIL KOOKMASTER

COLLECTION



DEVIL KOOKMASTER 30

ART. 0708061N

€ TBC
1 / 1 / 30

P 30 mbar

53,5 x 31 x 9,5 cm

P 2,4 kW x 2

3,6 kg

DEVIL KOOKMASTER 50

ART. 0708062N

€ TBC
1 / 1 / 30

P 50 mbar

53,5 x 31 x 9,5 cm

P 2,4 kW x 2

3,6 kg



DEVIL KOOKMASTER GP 30

ART. 0708063N

€ TBC
1 / 1 / 30

P 30 mbar

53,5 x 31 x 9,5 cm

P 2,4 kW x 2

5,3 kg

DEVIL KOOKMASTER GP 50

ART. 0708064N

€ TBC
1 / 1 / 30

P 50 mbar

53,5 x 31 x 9,5 cm

P 2,4 kW x 2

5,3 kg

Il fornello a gas Devil Kookmaster è un elemento culinario essenziale che rivoluziona la vostra esperienza di cucina outdoor. Realizzato con un'elegante superficie di cottura in acciaio inox, questo fornello a 2 fuochi combina funzionalità e stile. Grazie all'accensione piezoelettrica, l'accensione del fornello è semplice e immediata. Progettato con un comodo coperchio e una maniglia per un trasporto agevole, questo fornello è perfetto per le avventure all'aperto o come riserva affidabile anche a casa.

Il fornello a gas Devil Kookmaster GP è un elemento culinario essenziale che rivoluziona la vostra esperienza di cucina outdoor. Realizzato con un'elegante superficie di cottura in acciaio inox, questo fornello a 2 fuochi combina funzionalità e stile. Grazie all'accensione piezoelettrica, l'accensione del fornello è semplice e immediata. Progettato con un comodo coperchio e una maniglia per un trasporto agevole, questo fornello è perfetto per le avventure all'aperto o come riserva affidabile anche a casa. Il Devil Kookmaster GP viene fornito con una piastra di cottura liscia e una piastra di cottura rigata.

Il Devil Kookmaster Standalone offre la stessa funzionalità impareggiabile del Devil Kookmaster. Con le sue quattro gambe robuste e un comodo vassoio, questa cucina essenziale permette di cucinare in modo professionale anche all'aperto. Il Devil Kookmaster Standalone viene fornito con una piastra di cottura liscia e una piastra di cottura rigata.

originaldesign



DEVIL KOOKMASTER STANDALONE 30

ART. 0708065N

€ TBC
1/1/-

P 30 mbar

L 54,5 x 31 x 80,5 cm

P 2,4 kW x 2

W 9 kg

DEVIL KOOKMASTER STANDALONE 50

ART. 0708066N

€ TBC
1/1/-

P 50 mbar

L 54,5 x 31 x 80,5 cm

P 2,4 kW x 2

W 9 kg

WINDPROOF BRACKETS



COFFEE MACHINE ADAPTER



GRILLING PLATES



SCREWING AND UNSCREWING LEGS



HANDY TRAY



HEIGHT ADJUSTABLE LEG









FLAMINA ULTRACOMPACT S

ART. 0708011N

€ TBC
4 / 40 / 520

-  10,5/15,5 x 10,5/15,5 x H 8 cm
-  8 x 8,5 x H 9,5 cm
-  3 kW
-  238 g





Mini-fornello gas pieghevole realizzato in resistente acciaio e con braccetti di supporto dentellati salvaspazio. Dotato di ottimo bruciatore, manopola di regolazione della fiamma e di accensione piezoelettrica integrata. Praticissimo da trasportare e riporre nel suo contenitore in materiale plastico.



FLAMINA ULTRACOMPACT L

ART. 0708012N

€ TBC
4 / 24 / 504



-  Ø 17,5 / 18 cm x H 9,5 cm
-  Ø 9,5 cm x H 9,5 cm
-  3,5 kW
-  374 g

Fornello gas pieghevole ultraleggero in acciaio per camping ed Outdoor. Completo di accensione piezoelettrica e valvola di collegamento con manopola di regolazione della fiamma. Facile da riporre e trasportare nella sua pratica sacca custodia.

ATREA

ART. 0712090N

€ TBC

-  7,4 x 4 x H 22,3 cm
-  160 g



Comoda bilancia portatile pesa bombole o bagagli, con metro a nastro incorporato. Da portare sempre con sé in viaggio per essere più sicuri del peso trasportato evitando quindi spiacevoli sorprese. Pesa fino a 34 kg. Piccola, leggera e robusta.



FIRESTICK

ART. 0712135N

€ TBC
10 / 200 / -

-  23,5 x 1,5 x 1,5 cm
-  75 g

Accendino ricaricabile USB con braccio flessibile ed interruttore integrato. La soluzione pratica, sicura e sostenibile per accendere fornelli e grill a gas. Corpo in metallo. Completo di cavetto di ricarica micro-USB.



PULSE
IGNITION





DO NOT TOUCH



PHOENIX 30

ART. 0708052N





€ TBC
1 / 5 / 80

-  30 mbar - without flame failure device
-  45,9 x 29,6 x H 8,2 cm
-  2x 1,2 kW
-  1,6 kg

PHOENIX 50

ART. 0708056N

€ TBC
1 / 5 / 70

-  50 mbar - without flame failure device
-  45,9 x 29,6 x H 8,2 cm
-  2x 1,2 kW
-  1,6 kg

Fornello a gas a 2 fuochi con bruciatori regolabili. Resistente struttura in metallo verniciato a polvere. Funzionamento con bombole a gas.

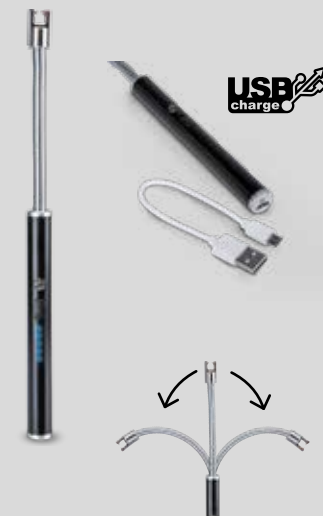



USB
charge

FLEXIBLE NECK
360° ROTATE

DEVIL MEGAHEATER L

ART. 0708022N

€ TBC
1/1/- 37,5 x 20,5 x 37,0 cm 3,7 kg 2,5 kW



Godetevi il calore e l'intimità con le nostre stufe a gas portatili ad alta efficienza. Questi apparecchi sono dotati di piastrelle riscaldanti per una distribuzione ottimale del calore e funzionano senza elettricità, creando una soluzione di riscaldamento altamente affidabile. Dotate di numerose funzioni di sicurezza, tra cui un sensore di basso livello di ossigeno e un dispositivo di sicurezza contro l'interruzione della fiamma, possono essere utilizzate in tutta tranquillità. Questo termoventilatore compatto e leggero è facile da trasportare e da riporre ed è perfetto per l'uso all'aperto.

CARATTERISTICHE:



- Ampia maniglia per un trasporto comodo e sicuro
- Accensione piezoelettrica
- Griglia di protezione
- Riduttore di pressione di alta qualità
- Piastrelle radianti ad alta efficienza
- Funziona con cartucce di gas filettate standard
- Luce LED integrata con interruttore

DEVIL MEGAHEATER XL

ART. 0708023N

€ TBC
1/1/- 47,0 x 20,5 x 37,0 cm 4,8 kg 2,5 kW**DEVIL HEATER SD**

ART. 0708025N

€ TBC
6/6/48 31,5 x 17 x H27,5 cm 1,5 kg 1,2 kW

Stufetta gas portatile con pannello radiante a raggi infrarossi. Accensione piezoelettrica. Funzionamento con bombolette gas munite di valvola normalmente reperibili in commercio (non incluse nella fornitura). Consumo: 90 g/h

**DEVIL HEATSTAR**

ART. 0708040N

€ TBC
4/24/- 15,5 x Ø 11,5 cm 320 g

Stufetta radiante per fornelli a gas Devil. Trasforma una normale fiamma generata dal fornello in energia termica. Costruzione in acciaio inox resistente alle alte temperature. Montaggio semplice e rapido mediante attacco a baionetta.





DEVIL BBQRUISER

COLLECTION

La linea di griglie a gas portatili BBQruiser rappresenta una serie di varianti di alta qualità dotate di tutti i sistemi per una grigliata sana e moderna. Questi grill sono progettati per offrire prestazioni e comodità eccezionali. Il cuore del BBQruiser è un potente bruciatore in acciaio inox con accensione piezoelettrica, che consente di raggiungere la temperatura perfetta per le vostre grigliate. Il coperchio di chiusura crea un ambiente simile a quello del forno, consentendo di esplorare una varietà di tecniche di cottura. Le piastre BBQruiser sono dotate di un rivestimento in ceramica che garantisce una cottura più sana, in quanto contribuisce a ridurre la formazione di composti nocivi durante il processo di grigliatura. La vaschetta di raccolta del grasso smaltata è facile da rimuovere, rendendo la pulizia un gioco da ragazzi. Le stabili gambe del BBQruiser sono progettate per un facile montaggio, garantendo una configurazione sicura e robusta. Per una maggiore praticità, il grill viene fornito con una borsa multifunzionale che consente di trasportare e riporre l'unità con facilità. Il BBQruiser è dotato di un supporto per padelle, di vari tipi di griglie (a scelta) e di un coperchio con termometro integrato. Questo pacchetto completo fornisce gli strumenti e le funzioni necessarie per un'esperienza da professionista nel campo delle grigliate.



Il Devil BBQruiser LT è il grill a gas portatile di ultima generazione, progettato per essere comodamente appoggiato sul tavolo dai camperisti in movimento! Realizzato con materiali di alta qualità e caratteristiche di design innovative, questo grill è il modo migliore per ottenere pasti succulenti e gustosi all'aria aperta. Compatto e leggero, è facile da riporre e da trasportare, e i suoi potenti bruciatori assicurano ogni volta una cottura deliziosa. Disponibile in 2 versioni.



DOME LID WITH HANDLE



EASY-TO-READ TEMPERATURE GAUGE



RIBBED GRID



GAS CONSUMPTION: 290 G/H



DEVIL BBQRUISER LT 30

ART. 0708073N

€ TBC
1/1/12

P 30 mbar

Ø 47 x 43 cm

P 4 kW

10,5 kg

DEVIL BBQRUISER LT 50

ART. 0708074N

€ TBC
1/1/12

P 50 mbar

Ø 47 x 43 cm

P 4 kW

10,5 kg



OPTIONAL



BBQRUISER LEG KIT

ART. 0708075N

€ TBC
2/6/-

Kit gambe con vassoio per trasformare il BBQruiser LT in BBQruiser HT.



DEVIL BBQRUISER HT REVERSIBLE GRID 30

ART. 0708076N

€ TBC
1 / 1 / 12

P 30 mbar

62 x 59 x 99,6 cm

P 4 kW

11,6 kg

DEVIL BBQRUISER HT REVERSIBLE GRID 50

ART. 0708077N

€ TBC
1 / 1 / 12

P 50 mbar

62 x 59 x 99,6 cm

P 4 kW

11,6 kg

3 HEIGHTS



LOW
(TABLE USE)

MEDIUM

HIGH

Il Devil BBQruiser HT è il grill a gas portatile di ultima generazione, ideato per essere regolato a tre altezze diverse, perfetto per i camperisti in movimento! Realizzato con materiali di alta qualità e caratteristiche di design innovative, questo grill è il modo migliore per ottenere pasti succulenti e gustosi all'aria aperta. Compatto e leggero, è facile da riporre e da trasportare, e i suoi potenti bruciatori assicurano ogni volta una cottura deliziosa. Disponibile in 2 versioni.

REVERSIBLE GRID Ø 46 CM



RIBBED

FLAT



NEW
2025

DEVIL BBQRUISER HT CLASSIC GRID 30

ART. 0708071N

€ TBC
1/1/12**P** 30 mbar

62 x 59 x 99,6 cm

P 4 kW

10,5 kg

NEW
2025

DEVIL BBQRUISER HT ROUNDGRID 30

ART. 0708084N

€ TBC
1/1/12**P** 30 mbar

62 x 59 x 99,6 cm

P 4 kW

11,6 kg

NEW
2025

DEVIL BBQRUISER HT ROUNDPAN 30

ART. 0708082N

€ TBC
1/1/12**P** 30 mbar

62 x 59 x 99,6 cm

P 4 kW

11,6 kg

DEVIL BBQRUISER HT CLASSIC GRID 50

ART. 0708072N

€ TBC
1/1/12**P** 50 mbar

62 x 59 x 99,6 cm

P 4 kW

10,5 kg

DEVIL BBQRUISER HT ROUNDGRID 50

ART. 0708085N

€ TBC
1/1/12**P** 50 mbar

62 x 59 x 99,6 cm

P 4 kW

11,6 kg

DEVIL BBQRUISER HT ROUNDPAN 50

ART. 0708083N

€ TBC
1/1/12**P** 50 mbar

62 x 59 x 99,6 cm

P 4 kW

11,6 kg

CARATTERISTICHE:

- Struttura portatile senza coperchio
- Griglia rotonda con rivestimento antiaderente
- Gambe separabili per un ingombro ridotto
- Controllo del livello - una gamba regolabile in altezza
- Borsa per il trasporto inclusa

CARATTERISTICHE:

- Costruzione portatile
- Griglia rotonda con rivestimento antiaderente
- Coperchio con termometro integrato
- Gambe separabili per un ingombro ridotto
- Controllo del livello - una gamba regolabile in altezza
- Borsa per il trasporto inclusa

CARATTERISTICHE:

- Costruzione portatile
- Padella rotonda con rivestimento antiaderente
- Coperchio con termometro integrato
- Gambe staccabili per un ingombro ridotto
- Controllo dell'altezza - una gamba regolabile
- Borsa per il trasporto inclusa



BBQRUISER DOME

ART. 0708080N



Ø 47 cm

€ TBC

1 / 1 / -

Coperchio di grandi dimensioni per grill BBQRuiser.

CARATTERISTICHE:

- Rivestimento resistente al calore
- Termometro integrato
- Impugnatura resistente al calore con scudo termico interno
- Può essere utilizzato come frangivento
- Con aperture di ventilazione laterali



BRASEIRO

ART. 0708087N

36,5 x 25,5 x 17,5

€ TBC

6 / 12 / -

255 g

Utensili da barbecue compatti in acciaio inox con manici in plastica resistenti al calore. Ideali per girare i cibi sul barbecue. Grazie alla forma ergonomica dei manici, questo set di posate per barbecue si tiene comodamente in mano e offre un ottimo controllo durante le grigliate. Fornito con un pratica borsa per riporre e trasportare facilmente il prodotto.



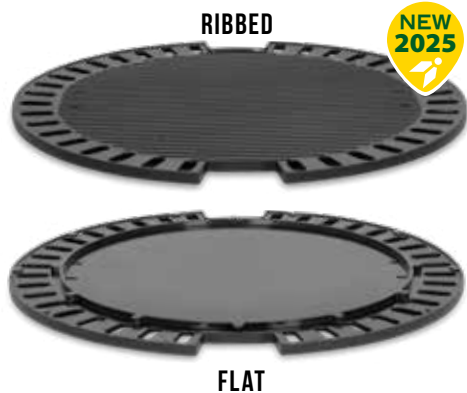

RIBBED

NEW
2025

REVERSIBLE PLATE

ART. 0708088N

€ TBC
6 / 6 / -

Ø 46 cm



Padella rotonda adatta a tutti i modelli di grill BBQruiser. Rivestimento in ceramica.

NEW
2025

RIBBED GRILL PLATE

ART. 0708079N

€ TBC
6 / 6 / -

Ø 46 cm

Piastra rigata adatta a tutti i modelli di grill BBQruiser. Rivestimento in ceramica.

NEW
2025

ROUND PAN

ART. 0708081N

€ TBC
6 / 6 / -

Ø 46 cm

Padella rotonda adatta a tutti i modelli di grill BBQruiser. Rivestimento in ceramica.



PIZZA PLATE BBQRUISER

ART. 0708078N

€ TBC
4 / 4 / -

Ø 34 x H1,5 cm

2,26 kg



La nuova piastra Pizza plate BBQ è l'accessorio definitivo per il vostro barbecue portatile Brunner BBQruiser. Realizzata in CORDIERITE naturale, questa piastra resistente e inodore offre un'impareggiabile tenuta della temperatura e una distribuzione uniforme del calore. La sua porosità garantisce inoltre un'efficiente assorbimento dell'umidità, per ottenere ogni volta pizze perfettamente cotte e croccanti. Migliorate la vostra cucina outdoor e sperimentate i veri sapori di una pizza a legna direttamente in camping.

NEW
2025

NOSTIK

ART. 0708086N

€ TBC
10 / 50 / -

Ø 46 cm

Il tappetino antiaderente per grigliate rivoluziona il modo di cucinare all'aperto. Realizzato con materiali al 100% privi di PFOA, offre una superficie sicura e durevole per le grigliate senza il problema del cibo attaccato. Progettato per adattarsi perfettamente alle piastre per grigliate BBQruisers, questo tappetino garantisce una vestibilità aderente e sicura, rendendolo una scelta versatile per l'uso su barbecue a carbonella, elettrici e a gas. La sua natura riutilizzabile e lavabile in lavastoviglie rende la pulizia un gioco da ragazzi, permettendovi di concentrarvi sulla creazione di piatti appetitosi con facilità.

CARATTERISTICHE:

- Realizzato con materiali al 100% privi di PFOA, non tossici, resistenti e riutilizzabili
- Può essere utilizzato universalmente su griglie rotonde
- Si adatta perfettamente alle piastre BBQRUISERS
- Riutilizzabili e lavabili in lavastoviglie
- Adatto per barbecue a carbonella, elettrici e a gas



GAS REG

GAS REG D

50



30



Regolatori a gas per bassa pressione, adatti per bombole gas germaniche con un peso lordo fino a 14 kg. Solo per utilizzo per campeggio (grill a gas, fornelli, lampade, ecc.).

GAS REG

50



30



Regolatore gas per bombole da campeggio. Con dispositivo di sicurezza anti-rottura del tubo. Testato DIN-DVGW.

GAS REG ITA

30



Regolatore gas per bombole di fabbricazione italiana. Testato IMQ.

		<i>p</i>		PACK	M.O.	Master	
GAS REG D	ART. 0712059C	50 mbar	1/4" L	1X	€ TBC	5	10 -
GAS REG D	ART. 0712059N	50 mbar	1/4		€ TBC	10	50 -
GAS REG D	ART. 0712063C	30 mbar	1/4" L	1X	€ TBC	5	10 -
GAS REG D	ART. 0712063N	30 mbar	1/4		€ TBC	10	50 -
GAS REG 50	ART. 0712157C	50 mbar	1/4" L	1X	€ TBC	5	10 -
GAS REG 50	ART. 0712157N	50 mbar	1/4		€ TBC	10	50 -
GAS REG	ART. 0712158C	30 mbar	Ø 8 mm	1X	€ TBC	5	10 -
GAS REG	ART. 0712158N	30 mbar	Ø 8 mm		€ TBC	10	50 -
GAS REG ITA	ART. 0712243C	30 mbar	1/4" L - Ø 8 mm	1X	€ TBC	5	10 -
GAS REG ITA	ART. 0712243N	30 mbar	1/4" L - Ø 8 mm		€ TBC	10	50 -



GAS KIT

Kit di collegamento composto da un regolatore a bassa pressione con taratura fissa (30 mbar), 1,5m di tubo GPL e 2 fascette stringitubo.
0712168N -> Adatto per bombole attacco Italia.
0712170N -> Adatto per bombole attacco CG.



GAS KIT

ART. 0712168N

€ TBC
5 / 10 / -

GAS REG CARTRIDGE



ART. 0712078N

€ TBC
5 / 10 / -

p 30 mbar



ART. 0712079N

€ TBC
5 / 10 / -

p 50 mbar

Gruppo regolatore che consente di alimentare apparecchi gas a bassa pressione mediante cartucce gas filettate EN417 evitando di dover trasportare pesanti bombole gas. Disponibile in 2 versioni.

Versione 30mbar: attacco portagomma, senza tubo gas

Versione 50mbar: attacco 1/4' sx, con tubo gas



GAS KIT CG

ART. 0712170N

€ TBC
5 / 10 / -

CALIBER

ART. 0712076N

€ TBC
10 / 100 / -



Praticissimo adattatore per utilizzare le diffusissime cartucce gas 227g come bombolette gas filettate.

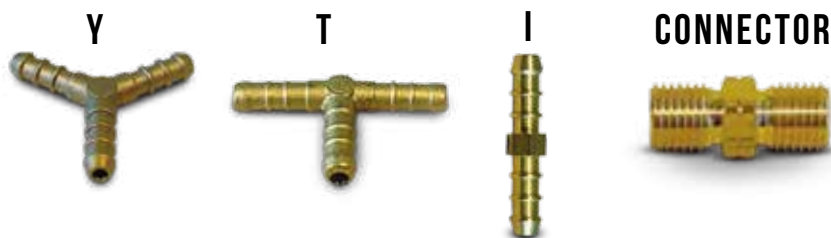

CONNECTOR



Raccordo portagomma.

			PACK	€ TBC	M.O.	Master	
CONNECTOR Y	ART. 0712014C	3x Ø 8 mm	1X	€ TBC	5	10	-
CONNECTOR Y	ART. 0712014N	3x Ø 8 mm		€ TBC	10	200	-
CONNECTOR T	ART. 0712029C	3x Ø 8 mm	1X	€ TBC	5	10	-
CONNECTOR T	ART. 0712029N	3x Ø 8 mm		€ TBC	10	200	-
CONNECTOR I	ART. 0712224C	2x Ø 8 mm	1X	€ TBC	5	10	-
CONNECTOR I	ART. 0712224N	2x Ø 8 mm		€ TBC	10	200	-
CONNECTOR	ART. 0712270C	2x 1/4" L	1X	€ TBC	5	10	-
CONNECTOR	ART. 0712270N	2x 1/4" L		€ TBC	10	200	-

ADAPTOR ITA



ITA

ITA-CG

ITA-DE



Adattatore da connessione.

			PACK	€ TBC	M.O.	Master	
ADAPTOR ITA	ART. 0712251C	1/4" L - Ø 8 mm	1X	€ TBC	5	10	-
ADAPTOR ITA	ART. 0712251N	1/4" L - Ø 8 mm		€ TBC	10	200	-
ADAPTOR ITA-CG	ART. 0712011C		1X	€ TBC	5	10	-
ADAPTOR ITA-CG	ART. 0712011N			€ TBC	10	200	-
ADAPTOR ITA-DE	ART. 0712080C		1X	€ TBC	5	10	-
ADAPTOR ITA-CG	ART. 0712080N			€ TBC	10	200	-

G-HOSE





Tubo gas per collegamento a regolatore bassa pressione. Da utilizzare con grill a gas, fornelli, frigoriferi, lanterne, ecc. Resistente fino a -20°C.

G-HOSE ITA

ART. 0712248N

€ TBC
1 / 1 / -
 Ø int. 8 mm x 50 m

Tubo gas in PVC rinforzato. Conforme alla normativa UNI-CIG. Omologato.

				PACK	€ TBC	M.O.	Master	
G-HOSE 100	ART. 0712124C	100 cm	1/4" L - 1/4" L	1X	€ TBC	5	10	-
G-HOSE 100	ART. 0712124N	100 cm	1/4" L - 1/4" L		€ TBC	5	25	-
G-HOSE 200	ART. 0712074C	200 cm	1/4" L - 1/4" L	1X	€ TBC	5	10	-
G-HOSE 200	ART. 0712074N	200 cm	1/4" L - 1/4" L		€ TBC	5	25	-
G-HOSE 300	ART. 0712075C	300 cm	1/4" L - 1/4" L	1X	€ TBC	5	10	-
G-HOSE 300	ART. 0712075N	300 cm	1/4" L - 1/4" L		€ TBC	5	25	-



HOUSEHOLD

**CONTENITORI E BACINELLE
PORTARIFIUTI
STENDIBIANCHERIA**

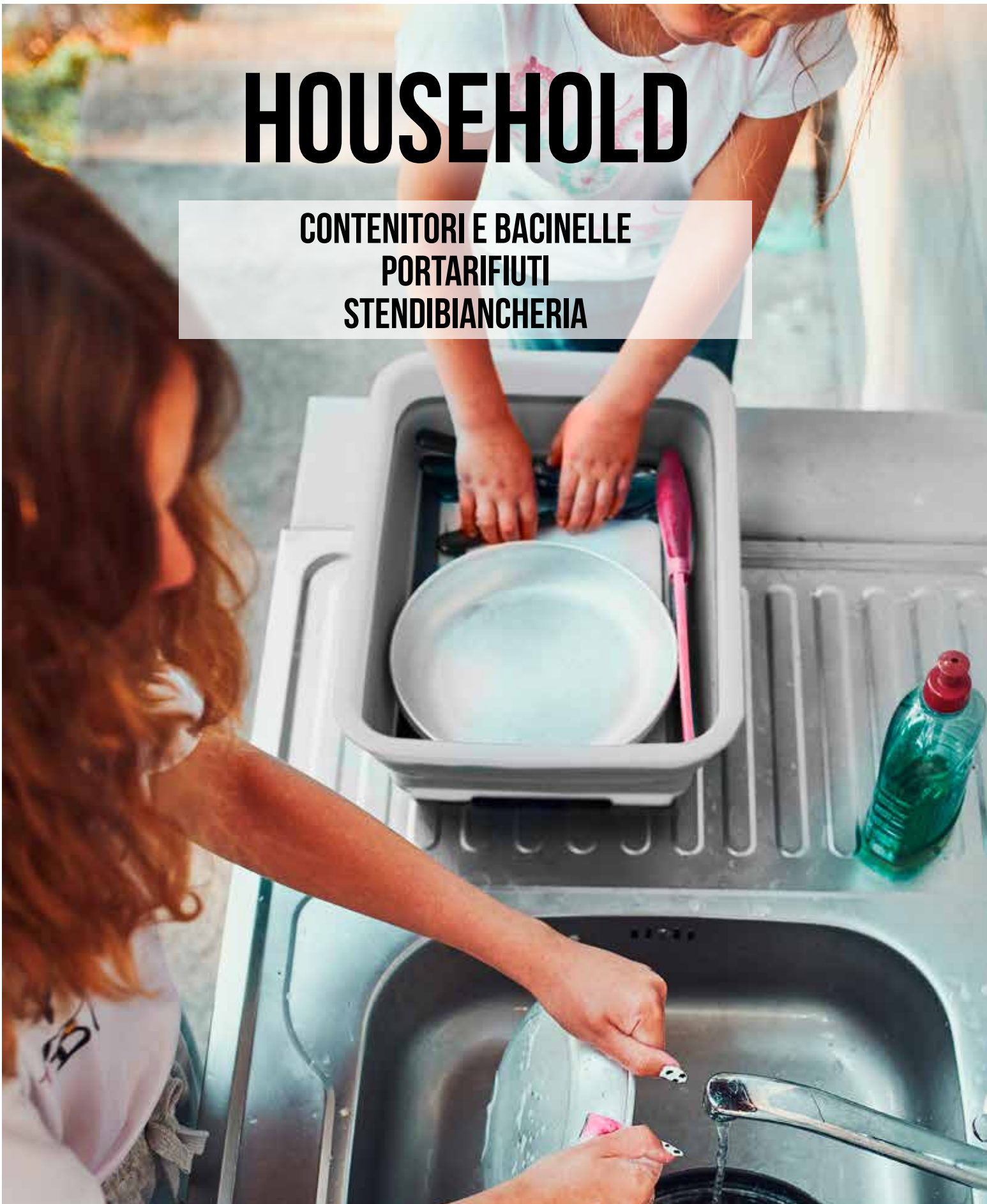

MY CAMPER MY HOME



Nelle pagine seguenti vi presentiamo pratiche innovazioni per la gestione domestica del vostro veicolo ricreazionale. L'obiettivo è di fare in modo che in camper ci si senta a proprio agio come se si fosse a casa propria e questo, ovviamente, senza dover rinunciare alle comodità di tutti i giorni. Perché una cosa è chiara a tutti i campeggiatori: la casa viaggia sempre con noi e deve essere curata di conseguenza.

NE RISULTA UNA MOLTITUDINE DI DOMANDE:

- Qual è il modo migliore per lavare le mie stoviglie?
- Come evitare odori fastidiosi all'interno del veicolo?
- Quali soluzioni sono disponibili per conservare piatti e bicchieri in modo sicuro?

E molto altro ancora a cui cerchiamo di dare una risposta con suggerimenti focalizzati su prodotti e soluzioni innovative - con il chiaro obiettivo di dare un contributo attivo per rendere la vacanza in camper il più piacevole possibile.

HOLDALL FOLD-AWAY

INFO P. 313

16L



FOLD-AWAY





INFO

FOLD-AWAY



I casalinghi pieghevoli sono un'alternativa salvaspazio alle tradizionali ciotole, secchi e bacinelle e non dovrebbero mancare in nessuna delle moderne attrezzature per camper. Sono molto facili da ripiegare, versatili e, soprattutto quando lo spazio è limitato, ideali per lo stivaggio. Per poterlo utilizzare, è sufficiente esercitare una piccola pressione sul fondo. Tutti i prodotti Brunner-FoldAway possono essere ripiegati con la stessa facilità dopo l'uso.

CARATTERISTICHE GENERALI DEL PRODOTTO:

- Materiale: Plastica PP/TPU a stabilità dimensionale
- Leggero
- Stivaggio salvaspazio
- Facile da pulire
- Durevole
- Sicuro da usare



VINIS FOLD-AWAY

ART. 0203062C.C9N

€ TBC
1 / 1 / -

Paniere collapsabile realizzato in materiale plastico TPE resistente al calore, alle rotture e facile da pulire. In caso di inutilizzo si ripiega in modo compatto.

CARATTERISTICHE:

- Adatto per uso alimentare
- Resistente al calore fino a 125°C
- Resistente al gelo
- Con maniglia da trasporto

- ✓ 14 l
- 📏 Ø 38 x H23 (+24) cm
- 📏 Ø 40 x H10 cm
- 📖 670 g

COLOR



FOLD-AWAY

CLEO FOLD-AWAY

ART. 0203064C.C9N

€ TBC
12 / 12 / 216

Bacinella collapsabile Cleo Fold-Away. Realizzata in materiale TPE/PP di alta qualità con comode maniglie pieghevoli.

- ✓ 13 l
- 📏 35,3 x 36,3 x H17 cm
- 📏 35,3 x 36,3 x H6,5 cm
- 📖 640 g

COLOR



FOLD-AWAY

FOR VINIS FOLD-AWAY ONLY



OPTIONAL

VINCAP FOLD-AWAY

ART. 0203065N

€ TBC
12 / 24 / -

Coperchio in materiale plastico (100% PP) per paniero Vinis Fold-Away.

- 📏 Ø 38 x 2,5 cm

IRIS FOLD-AWAY

ART. 0203067N.C59

€ TBC
12 / 12 / 288

- ✓ 9 l
- 📏 Ø 37,5 x H14 cm
- 📏 Ø 37,5 x H5 cm
- 📖 430 g



FOLD-AWAY

Lavello pieghevole costruito in resistente materiale plastico. Molto compatto da riporre e facile da trasportare grazie allo speciale sistema Fold-Away.



DRUM 10 FOLD-AWAY

ART. 0203069N

€ TBC

4 / 16 / 192



10 l

Ø 32 x H25 cm

Ø 32 x H7 cm

610 g

Secchio pieghevole in resistente materiale TPE/PP. Il pratico sistema Fold-Away permette di ripiegare in modo compatto e di risparmiare spazio.

COLORS C20 C70 C55



DRUM 15 FOLD-AWAY

ART. 0203074N

€ TBC

6 / 12 / 180



15 l

Ø 36 x H28 cm

Ø 36 x H8,2 cm

710 g

Secchio pieghevole in resistente materiale TPE/PP. Il pratico sistema Fold-Away permette di ripiegare in modo compatto e di risparmiare spazio.

COLORS C20 C70 C55



HOLDALL FOLD-AWAY

ART. 0203070N

€ TBC

6 / 12 / 144



16 l

46,1 x 34,2 x 18,4 cm

46,1 x 34,2 x 4,9 cm

550 g

Bacinella pieghevole realizzata in robusto materiale TPE/PP. Il pratico sistema Fold-Away consente di ripiegarla in modo compatto e di riporla in modo da risparmiare spazio.

COLORS C20 C70 C55



LOTUS FOLD-AWAY

ART. 0203068N

€ TBC

8 / 8 / 128



36 l

54 x 39 x 24 cm

54 x 39 x 7,1 cm

770 g

Bacinella ovale pieghevole in robusto materiale TPE/PP. Il pratico sistema Fold-Away consente di ripiegarlo in modo compatto e di riporlo in un luogo poco ingombrante.

COLORS C20 C70

BOWLIN



Ciotole pieghevoli salvaspazio in PP-TPR resistente al calore con bordo in plastica perimetrale. Compatte e leggere. Molteplici usi. Adatte per alimenti e lavabili in lavastoviglie. Disponibili in 3 misure.



		🔒	🔒	👤	€ TBC	M.O.	Master	📦
BOWLIN 20	ART. 0203076N.C20	Ø 20 x 8 cm	Ø 20 x 2,3 cm	155 g	€ TBC	20	100	-
BOWLIN 22	ART. 0203077N.C20	Ø 22 x 8,5 cm	Ø 22 x 2,5 cm	198 g	€ TBC	20	100	-
BOWLIN 25	ART. 0203078N.C20	Ø 25 x 10 cm	Ø 25 x 3 cm	283 g	€ TBC	20	100	500



DRIPDISH 90

ART. 0420037N

€ TBC

6 / 12 / 144

49,5 x 34 x 8,8 cm

850 g

Scolapiatti triangolare a 2 elementi realizzato in resistente materiale plastico. Ideale per l'utilizzo in spazi ristretti.



TANQ FOLD-AWAY

ART. 0203066N.C50

€ TBC

8 / 8 / 192

9 l

30,5 x 30 x 20 cm

30,5 x 30 x 6 cm

500 g

Lavello pieghevole realizzato in robusto materiale plastico con maniglie per il trasporto integrate e scolo chiudibile mediante tappo. Molto compatto da riporre e facile da trasportare grazie allo speciale sistema Fold-Away.

FOLD-AWAY



PURA

ART. 0420030N

€ TBC

10 / 40 / 400

Base Ø 10 x H3 cm - Brush Ø 8 x H12 cm

132 g

TPR / Polycarbonate / ABS

Spazzola per lavaggio stoviglie con serbatoio del detersivo integrato. Ideale per una pulizia efficace e delicata di stoviglie e pentole. Munita di speciale pulsante che aziona una piccola pompa inserita nel corpo della spazzola, permettendo un dosaggio mirato del detersivo da utilizzare.

CARATTERISTICHE:

- Corpo spazzola in robusto materiale plastico
- Serbatoio detersivo integrato con pulsante di dosaggio
- Con pratico piattino d'appoggio



DROPPER FOLD-AWAY

ART. 0420040N

€ TBC

6 / 12 / 108

36,5 x 31 x H12 cm

36,5 x 31 x H6 cm

980 g

Scolapiatti colossabile con portaposate. Realizzato in materiale plastico.



3WAYS FOLD-AWAY

ART. 0203073N.C50

€ TBC

6 / 12 / 216

40 x 31,8 x 13,5 cm

40 x 31,8 x 3 cm

550 g

Bacinella pieghevole realizzata in PP e silicone TPR alimentare che convince per la sua durata, l'assenza di odori e l'atossicità. Con la sua funzione 3 in 1, è versatile. Che si tratti di tagliare verdure, frutta e carne, di una bacinella pieghevole per la pulizia o di una vaschetta per sgocciolare piatti e alimenti, questa bacinella soddisfa tutte le esigenze.

FOLD-AWAY



FOLD-AWAY



TRIO

ART. 0420004N

€ TBC

12 / 24 / 384

Ø 28 x H77 cm

Ø 28 x H4 cm

300 g

Portaoggetti pensile. Composto da tre cestini inseribili in metallo.



**CLEO NG**

ART. 0203063N

€ TBC

24 / 24 / 288

 13 l

35 x 36 x 18 cm

430 g



Bacinella multiuso con manici pieghevoli.

VINIS

ART. 0203051N

€ TBC

10 / 420 / 420

 14 l

Ø 34 x H20,5 (+20) cm

400 g



Secchio multiuso in plastica alimentare.



FOR VINIS ONLY

**OPTIONAL****VINSERT**

ART. 0203052N

€ TBC

10 / 660 / 660

Ø 33 cm

220 g



Inserto per secchio multiuso Vinis. In plastica ad uso alimentare.

VINCAP

ART. 0203058N

€ TBC

12 / 48 / -

Ø 36,3 x H2,3 cm

190 g



Coperchio in materiale plastico per secchio multiuso Vinis.



waterproof



12 L

MERLIN

ART. 0203071N

€ TBC

6 / 36 / 360

 14 l
**ASSORTED**

Cesto multiuso in materiale plastico flessibile e ad uso alimentare.

POOL

ART. 0812011N

€ TBC

6 / 24 / 480

 12 l

29 x 29 x 16 cm

280 g

Polyester / PVC

Lavello pieghevole con bordo rinforzato.

**PANDORA**

ART. 0404021N

€ TBC

10 / 40 / -

Resistente portabevande in plastica per bottiglie.

CARATTERISTICHE:

- Con staffa di fissaggio flessibile
- Ideale per auto e camper
- Adatto per bottiglie fino a 2 litri

**GLASS BASE**

ART. 0830001N

€ TBC

12 / 48 / 1440

PACK 6X

Portabicchieri in plastica. Adatto per bicchieri in plastica da 200 ml. Colori assortiti.



BIO BOY

NEW
2025



10 PCS

BIO BOY BAGS

ART. 7427015N.R1

€ TBC
12 / 24 / -

PACK 10X

50 l

Sacchetti in plastica biodegradabile per contenitori portarifiuti Pillar.



EASY
SETUP



BIO BOY COMPACT

ART. 7427015N

€ TBC
12 / 12 / 144

32,5 x 28,5 x H66 cm

32,5 x 28,5 x H7 cm

650 g

Telaio portarifiuti smontabile realizzato in materiale plastico. Adatto per sacchetti rifiuti fino a 50 litri.

BIO BOY NG

ART. 7427017N

€ TBC
12 / 12 / 144

32,5 x 28,5 x H66 cm

32,5 x 28,5 x H7 cm

650 g

Telaio portasacchetto rifiuti con scomparto portasacchetti. Struttura in materiale plastico. Completo di 10 sacchetti portarifiuti.

10 BAGS INCLUDED



TRAPSY

ART. 7427035N

€ TBC
12 / 108 / 864

13,9 x 10,8 x 4,5 cm

85 g

Pratico portasacchetti per rifiuti utilizzabile in molteplici situazioni: veicoli ricreazionali, camping, nautica, cucina, bagno. Realizzato con telaio in materiale plastico a chiusura automatica bloccadori. Utilizzo anche con una mano sola. Montaggio semplice e rapido. La fornitura comprende 20 sacchetti portarifiuti (capacità 3,5 l ca).



TRAPSY BAGS

ART. 7427079N

€ TBC
12 / 120 / -

PACK 20X

3,5 l

Sacchetti di ricambio per portarifiuti Trapsy.



BIO- DEGRADABLE



PLITTER

ART. 7427026N

€ TBC
6 / 6 / 144

- 32 x 27,5 x H38,5 cm
- 31 x 38 x H6,5 cm
- 1,65 kg

Cestino per rifiuti con struttura pieghevole in materiale plastico.



BOGO

ART. 7427019N

€ TBC
10 / 40 / 160

- 27,5 x 35,5 x H36,5 cm
- 27,5 x 4,5 x 48 cm
- 300 g

Telaio portarifiuti pieghevole in materiale plastico.



SNAPSTER

ART. 7427028N

€ TBC
10 / 70 / 420

- 37,5 x 12,5 cm
- 100 g

Portasacchetti rifiuti con telaio in materiale plastico a chiusura automatica. Montaggio semplice e rapido a porte, ante e pareti.



One Way è un pratico portarifiuti utilizzabile a mani libere, che si aggancia a qualsiasi cassetto o mobiletto. Il telaio a clip intelligente garantisce un fissaggio sicuro dei sacchetti di plastica. One Way è perfetto per mantenere la cucina e il bagno puliti e in ordine.

CARATTERISTICHE:

- Utilizzo a mani libere
- Intelligente clip telaio
- Custodia robusta in plastica
- Montaggio facile e senza viteria
- Lavabile in lavastoviglie
- Con coperchio
- Per sacchetti della spazzatura da 30 l

ONE WAY

ART. 7427020N

€ TBC
10 / 80 / 400

- 23,7 x 11 x 2,9 cm
- 138 g
- PP

EASY **INSTALLATION**

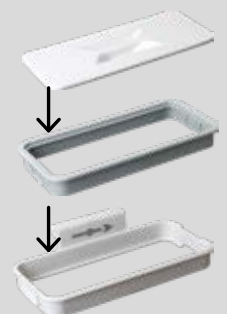

NOT INCLUDED



PILLAR

COLLECTION



360°



PILLAR

ART. 7427021N

€ TBC

8 / 8 / 112

22/26,5 x 9/12 x H30 cm

380 g

100% PP

5,5 l

Cestino pensile con coperchio ad apertura manuale dal design curato, innovativo e funzionale.

MONTAGGIO SEMPLICE MEDIANTE:

- Supporto di montaggio da avvitare a pareti o ante armadi
- Avvitamento

COLORS

C06

C00



360°

PILLAR XL

ART. 7427025N

€ TBC

6 / 6 / 60

31,5 x 18 x H31,5 cm

476 g

100% PP

10 l

Cestino portarifiuti pensile con coperchio.

MONTAGGIO SEMPLICE MEDIANTE:

- Supporto di montaggio da avvitare a pareti o ante armadi
- Mediante piastra di fissaggio regolabile in altezza da avvitare ad ante e porte
- Con speciale supporto da agganciare alla struttura tubolare dei mobiletti cucina

COLORS

C06

C00

318



25 PCS

25 PCS

OPTIONAL

PILLARBAG

ART. 7427008N

€ TBC

10 / 100 / -

PACK 25X

5,5 l

PILLARBAG XL

ART. 7427009N

€ TBC

10 / 50 / -

PACK 25X

10 l

Sacchetti in plastica biodegradabile per contenitori portarifiuti Pillar.



BIO- DEGRADABLE







PILLAR FOLD-AWAY

ART. 7427022N

€ TBC

6 / 12 / 96

 25,5 x 18,5 x H29 cm

 25,5 x 9,5 x H29 cm

 620 g

 PP - TPR

 8 l

Cestino portarifiuti con coperchio ad apertura manuale, caratterizzato da una struttura pieghevole Fold-Away che in caso di inutilizzo consente di ridurre il suo volume d'ingombro di più del 50%. Corpo in resistente materiale termoplastico con fascia in TPR. Utilizzo come portarifiuti indipendente da pavimento oppure appeso a pareti, porte o ante.

FOLD-AWAY





EXPRESS

ART. 7202810N

€ TBC
15 / 30 / 540

Ø 45 cm

Stendibiancheria rotondo in materiale plastico. Con 10 aste ripiegabili e 20 mollette.



JOKER

ART. 7202805N

€ TBC
6 / 12 / 216

Ø 45 cm

Stendibiancheria ovale con 24 mollette in materiale plastico di alta qualità. Gancio di fissaggio con chiusura a molla.



SUN TIME

ART. 7202808N

€ TBC
10 / 20 / 300

70 x 34 cm

Stendibiancheria rettangolare in materiale plastico. Con 34 mollette. Pieghevole.



POPS

ART. 7202824N



€ TBC
12 / 48 / 720

max. 90 cm

102 g

Stendibiancheria con ventose.



DRYLINE

ART. 7202799N

€ TBC
12 / 72 / -

1,5 m

Corde stendibiancheria elastica utilizzabile senza mollette. I singoli indumenti vengono incastrati tra i filamenti elastici attorcigliati su loro stessi. Fissaggio mediante ventose.

RAPID METAL

ART. 7427050C

€ TBC
12 / 48 / -

40 cm

PACK 1X

Asta con sette ganci spostabili in plastica realizzata in metallo cromato.



BONE DRY

ART. 7202798N

€ TBC
20 / 100 / -

160 g

Corde stendibiancheria estensibile con 2 ganci di fissaggio alle estremità e 12 mollette in metallo. Lunghezza: 1,9 / 3,5 m.

ARIAL

ART. 7427054N

€ TBC
5 / 20 / 560

60 x 9,5 cm

Appendino a 8 ganci per caravan.



DRYWHEEL

ART. 7202802N

€ TBC
6 / 48 / -

5,5 m

Corde stendibiancheria in PP con pratico avvolgitore.

LAUN-TREE 3A



3A

Ø 40 MM

LAUN-TREE 3A

ART. 7202811N

€ TBC
6 / 6 / 54

 121 (x3) x H150 cm

 80 x 25 x 12 cm

 2,3 kg

Stendibiancheria con struttura pieghevole in alluminio anodizzato. Lunghezza complessiva corda: 14 metri.



metal



MARY

ART. 7202829N

€ TBC
12 / 24 / 288

 51 x 26 x 13 cm

 500 g

Stendibiancheria pratico e compatto per le finestre di camper e caravan.



metal



MARY XL

ART. 7202827N

€ TBC
5 / 10 / 100

 80,5 x 54,5 x 22 cm

 670 g

Stendibiancheria pratico e compatto per le finestre di camper e caravan.



3A

Ø 40 MM

LAUN-TREE 3A WITH EXTENSION

ART. 7202801N

€ TBC
6 / 6 / 36

 121 (x3) x H150 cm

 80 x 25 x 12 cm

 2,8 kg

Stendibiancheria Laun-Tree con supplemento in alluminio per dare più spazio alla biancheria. La lunghezza della corda aumenta a seconda del modello scelto di 7,2/7,5 m.



RUBBER

TIDY

ART. 0203020N

€ TBC
24 / 24 / 576

18 x 21 x 4,5 cm

160 g

Miniset paletta/scopetta di minimo ingombro. Realizzato in materiale plastico.



RUBBER

BUNNY

ART. 0203032N

€ TBC
10 / 60 / 360

27 x 21 x 4,5 cm

170 g

Set paletta/scopetta di minimo ingombro. Realizzato in materiale plastico.



RUBBER

SCOOPY

ART. 0203034N

€ TBC
10 / 40 / 240

34 x 23,5 x 10 cm

175 g

Set paletta/scopetta di ampie dimensioni.



BUTLER

ART. 0203030N

€ TBC
10 / 50 / 250

31 x 22 x 10,5 cm

150 g

Set paletta/scopetta in materiale plastico.



FRANKY

ART. 0203038N

€ TBC
8 / 8 / 200

125 x 26,5 cm

69 x 19 cm

450 g

Scopa per camping con speciale meccanismo di apertura che raddoppia la larghezza utile della spazzola. Dotata di pratica paletta raccogli polvere.



SPIK

ART. 0203035N

€ TBC
12 / 24 / 360

70/118 x 25 cm

340 g

Scopa per tende e verande con pratico manico telescopico.

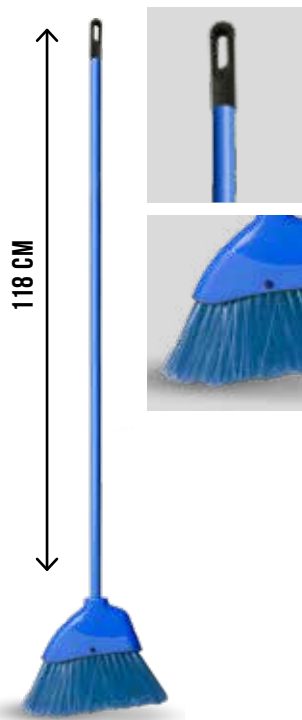

BENJAMIN

ART. 0203025N

€ TBC
12 / 24 / 504

118 x 25 cm

150 g

Pratica scopa per tende e verande.

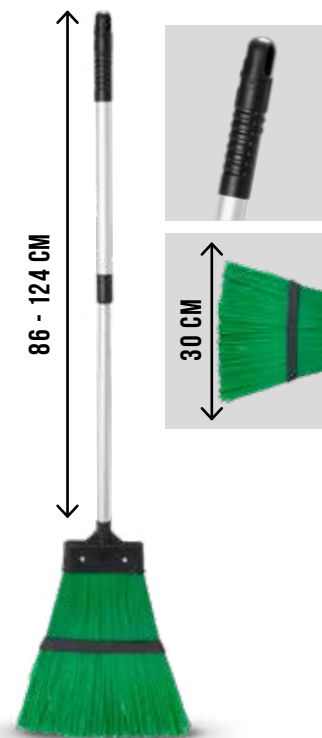

TOUCAN

ART. 0203033N

€ TBC
24 / 24 / 120

86/124 x 30 cm

700 g

Scopa per camping con manico telescopico in alluminio.

BARRICK



BARRICK SINGLE



Asta di bloccaggio con molla interna e terminali antiscivolo.



BARRICK DOUBLE

Doppia asta di bloccaggio per mobiletti e frigoriferi. Telescopico e bloccabile mediante rotazione.



				PACK		M.O.	Master	
BARRICK SINGLE S	ART. 0201100N	26/43 cm	20 g	2X	€ TBC	20	100	-
BARRICK SINGLE M	ART. 0201101N	41/71 cm	50 g	2X	€ TBC	20	100	-
BARRICK DOUBLE S	ART. 0201098N	26/43 x H8,5 cm			€ TBC	20	100	500
BARRICK DOUBLE M	ART. 0201099N	41/71 x H8,5 cm			€ TBC	20	100	500



SALVAR

ART. 0420046N

 34 x 25,5 x H6 cm

 110 g

Portabicchieri/portatazze universale in materiale espanso. 12 posizioni per bicchieri e tazze di diverse misure.



SOFT FOAMED PLASTIC

SALVAR SLOT

ART. 0420048N

 33,5 x 25 x H10 cm

 128 g

Portapiatti in schiuma EVA di alta qualità per trasportare fino a 10 piatti in modo sicuro e silenzioso in veicoli ricreativi ed imbarcazioni. Adatto per piatti piani, piatti fondi e piatti da dessert.

STAY MAT S

ART. 0201030N

€ TBC
24 / 24 / 960

 30 x 150 cm

 100% PVC

COLORS

C01

C06

C30

PHTHALATE free

Stuovia antiscivolo resistente e lavabile fino a 30°C. Tagliabile a piacere.



STAY MAT M

ART. 0201031N

€ TBC
24 / 24 / 576

 50 x 150 cm

 100% PVC

Stuovia antiscivolo resistente e lavabile fino a 30°C. Tagliabile a piacere.

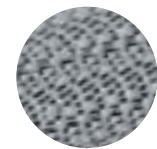



COOLING

**APPARECCHI REFRIGERANTI
BORSE TERMICHE
THERMOS**

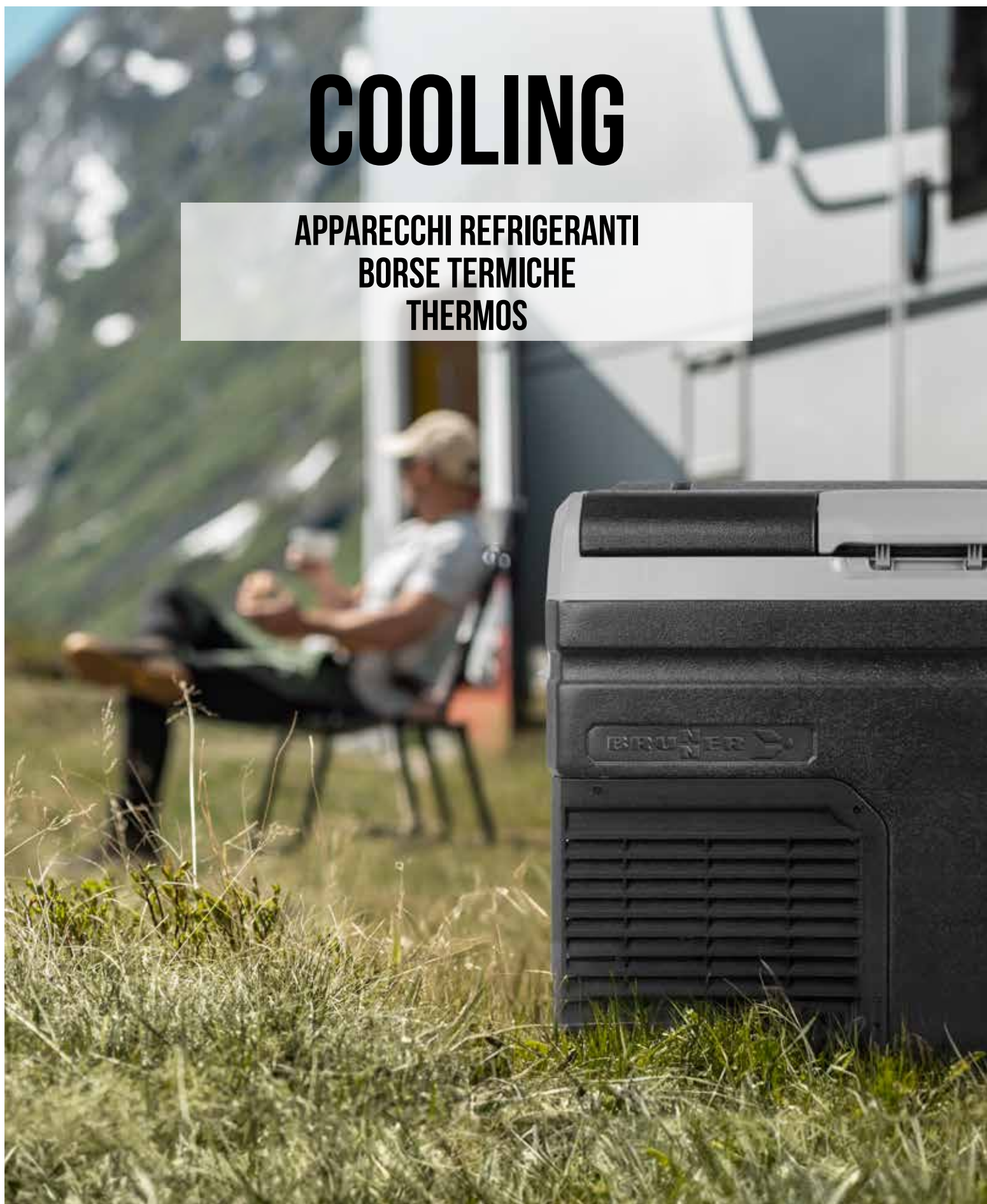

POLARYS

COLLECTION

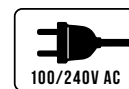

POLARYS FREEZE SZ

SZ30 • SZ40 • SZ50



POLARYS FREEZE DZ

DZ35 • DZ45



POLARYS PORTAFREEZE

8



POLARYS CRIOMASTER

25 • 40 • 73



POLARYS HOME

42



POLARYS TRAVEL

25 • 28





POLARYS FREEZE

SINGLE ZONE

Frigo/congelatore portatile a compressione con scomparto unico dal design moderno e compatto. Dotato di resistente corpo in materiale plastico antiurto ad alta capacità isolante ed un display digitale per il controllo della temperatura.

CARATTERISTICHE:

- Elevata velocità di raffreddamento
- Regolazione precisa mediante display digitale
- Ampio range temperatura
- Temperatura minima raggiungibile: -20°C
- Silenzioso, a basso consumo
- Voltaggio: 12V/24V (DC), 100/240V (AC)
- Tecnologia: Compressore LG

PRESTAZIONI:

• Regolazione della temperatura	tra +20°C e -20°C (surgelamento)
• Refrigerante tipo	R1234yf
• GWP	4
• Consumo medio di energia AC	(EN62552) 0,28 kWh/24h
• Consumo energetico 12V DC	(ambiente@32°C, interno@5°C) 1,29 Ah/h
• Classe climatica	(EN62552) T/ST/N/SN



<45DB QUIET

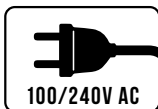

100/240V AC



12/24V DC



15 MIN FROM 20°C TO 0°C



FAR LESS THAN 1KWH PER DAY



360°



30ℓ LARGE CAPACITY



x42 355ml



x21 500ml



x13 750ml



MAX H27,8 cm 1,5 l

COOLING ROOM



SINGLE ZONE



30ℓ



40ℓ



50ℓ

POLARYS FREEZE SZ 30

ART. 0826052N

€ TBC
1/1/6

- 60,3 x 36,5 x H37,2 cm
- 10,9 kg
- 12/24V DC - 100/240V AC
- Max 60W / Eco 45W
- 30l

POLARYS FREEZE SZ 40

ART. 0826053N

€ TBC
1/1/6

- 60,3 x 36,5 x H44,2 cm
- 11,6 kg
- 12/24V DC - 100/240V AC
- Max 60W / Eco 45W
- 40l

POLARYS FREEZE SZ 50

ART. 0826054N

€ TBC
1/1/6

- 60,3 x 36,5 x H51,2 cm
- 12,3 kg
- 12/24V DC - 100/240V AC
- Max 60W / Eco 45W
- 50l

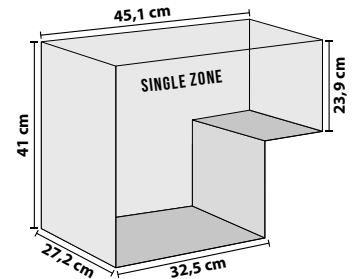
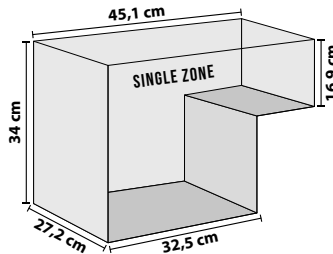
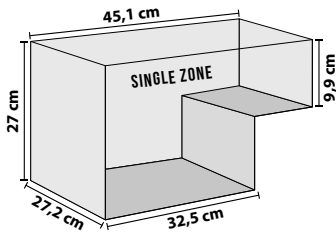

DIGITAL DISPLAY FOR TEMPERATURE CONTROL



REMOVABLE DOOR

REVERSE DOOR DESIGN MAKES DOOR OPENING MORE FLEXIBLE



AC 100/240V - DC 12/24V





Grazie ai nostri nuovi refrigeratori/congelatori Dual Zone potrete godervi l'estate in modo estremamente piacevole: Eccezionale capacità di raffreddamento e congelamento allo stesso tempo in un unico dispositivo! Due zone di temperatura regolabili separatamente (Dual Zone) e una batteria staccabile (opzionale) rendono i Polarys Freeze coolers i compagni ideali per tutte le attività all'aperto senza doversi preoccupare dell'alimentazione elettrica.

CARATTERISTICHE:

- Batteria staccabile (opzionale) della durata di 4-24 ore
- Due scomparti interni (Dual Zone) con controllo individuale della temperatura
- Compressore LG di alta qualità per prestazioni di raffreddamento di alto livello
- Protezione della batteria a tre stadi
- Design durevole ed antiurto
- Display LCD con controllo touch
- App Bluetooth per la regolazione della temperatura
- Funzionamento silenzioso
- Coperchio girevole che permette l'apertura da entrambi i lati
- Testato CE/RoHS
- La fornitura include: unità di raffreddamento, 1 cavo di collegamento CC, 1 cavo di collegamento CA, istruzioni per l'uso

POLARYS FREEZE

DUAL ZONE



POLARYS FREEZE
DUAL ZONE APP



35ℓ



45ℓ

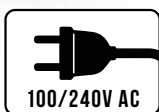

POLARYS FREEZE DZ35

ART. 0826049N

€ TBC
1 / 1 / 6

64,7 x 40 x H44,1 cm

15,6 kg

12/24V DC - 100/240V AC

Max 60W / Eco 45W

35 l (25+10)

PRESTAZIONI:

• Regolazione della temperatura	tra +20°C e -20°C (surgelamento)
• Refrigerante tipo	R1234yf
• GWP	4
• Consumo medio di energia AC	(EN62552) 0,28 kWh/24h
• Consumo energetico 12V DC	(ambiente@32°C, interno@5°C) 1,29 Ah/h
• Classe climatica	(EN62552) T/ST/N/SN



POLARYS FREEZE DZ45

ART. 0826050N

€ TBC
1 / 1 / 6

64,7 x 40 x H50,5 cm

16,5 kg

12/24V DC - 100/240V AC

Max 60W / Eco 45W

45 l (32+13)

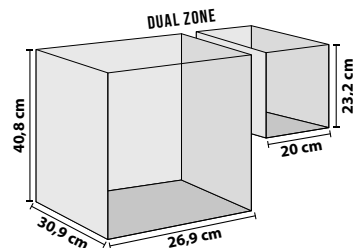
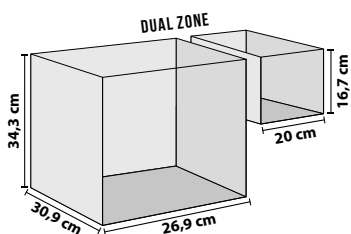

POLARYS PORTAFREEZE

Frigorifero a compressore AC 100-240V / DC 12/24V portatile concepito appositamente per l'utilizzo in spazi ridotti e per essere facilmente trasportato mediante il suo robusto maniglione pieghevole. Ideale per tutte le attività all'aperto, anche grazie alla possibilità di un'alimentazione mobile mediante l'utilizzo di una batteria al litio (opzionale). Costruzione solida e robusta realizzata con materiali di ottima qualità. Dotato di compressore di ultima generazione che ottimizza il rapporto tra consumo energetico e prestazione raffreddante.

CARATTERISTICHE:

- Batteria staccabile (opzionale) della durata di 4-24 ore
- Compressore di alta qualità per prestazioni di raffreddamento di alto livello
- Protezione della batteria a tre stadi
- Funzionamento DC/AC (AC con alimentatore esterno)
- Design durevole ed antiurto
- Display LCD
- Funzionamento silenzioso
- Maniglione per il trasporto pieghevole

POLARYS PORTAFREEZE

ART. 0826047N

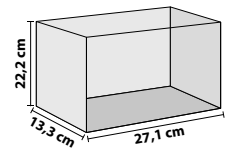
€ TBC
1 / 1 / 18

39,3 x 25,1 x H44,3 cm

7,8 kg

AC 100-240V / DC 12/24V

45W / Eco 35W

8,8 l

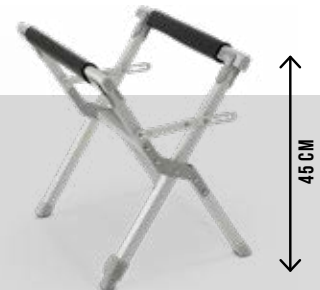
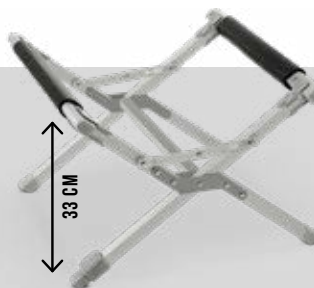
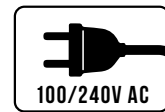

OPTIONAL

POLARYS E-PACK 15

ART. 0826043N

€ TBC
1 / 1 / -

15600 mAh / 173 Wh

Con la batteria ricaricabile agli ioni di litio E-Pack 15, entrambi i frigobox a compressore della linea Polarys Freeze DZ e Portafreeze possono essere alimentati con energia mobile quando non è disponibile un'alimentazione convenzionale. A seconda del livello di refrigerazione, il contenuto dei frigobox viene mantenuto freddo fino a 8 ore.

Tensione: 11,1V
Capacità: 15600 mAh/173 Wh
Tensione di carica: 12,6V
Tempo di ricarica: 8h ca.

COOLER UP

ART. 0406047N

€ TBC
1 / 1 / 120

45 x 50 x H33/45 cm

63 x Ø 12 cm

1,5 kg

Telaio portafrigo pieghevole e regolabile su due altezze. Completo di custodia.





POLARYS CRIOMASTER

Le prestazioni si fondono con l'efficienza: con la sua potente tecnologia a compressore, i Polarys Criomaster consentono di raggiungere temperature fino a -20°C. Inoltre, convincono per il loro bassissimo consumo di energia e per il funzionamento praticamente silenzioso. Sia che vengano utilizzati a 12V, 24V o 230V, il Criomaster garantisce un raffreddamento efficace. Dimensioni per ogni esigenza: A prescindere che siano 25, 40 o 73 litri, i Criomaster si adattano facilmente alle esigenze più varie. Grazie alla loro moderna interfaccia utente, è possibile impostare con precisione anche la temperatura.

PRESTAZIONI:

• Regolazione della temperatura	tra +20°C e -20°C (surgelamento)
• Refrigerante tipo	R600A
• GWP	3
• Consumo medio di energia AC	0,2 kWh/24h
• Consumo energetico 12V DC	ambiente@25°C, interno@5°C
• Classe climatica	N/ST/T



COOLING ZONE



SINGLE ZONE

COOLING ZONE



DUAL ZONE



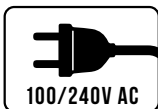

CARATTERISTICHE:

- Perfetti per raffreddare cibi e bevande per più persone
- Alloggiamento con eccellenti proprietà isolanti
- Alta velocità di raffreddamento
- Impostazione precisa tramite display digitale
- Design moderno e funzionale
- Temperatura minima raggiungibile: -20°C
- Bassa rumorosità, basso consumo
- Classe di efficienza energetica: A



25ℓ

POLARYS CRIOMASTER 25

ART. 0826035N

€ TBC
1/1/-

61,2 x 39,9 x 40,7 cm

12 kg

12/24V DC - 230V AC

45W

+20° / -20°

25 l

40ℓ

POLARYS CRIOMASTER 40

ART. 0826036N

€ TBC
1/1/-

69,6 x 45,5 x 41 cm

14 kg

12/24V DC - 230V AC

45W

+20° / -20°

40 l

73ℓ

POLARYS CRIOMASTER 73

ART. 0826037N

€ TBC
1/1/-

88,8 x 49,7 x 47 cm

20 kg

12/24V DC - 230V AC

45W

+20° / -20°

73 l

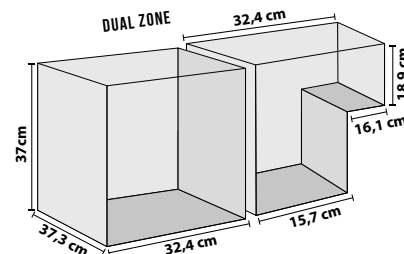
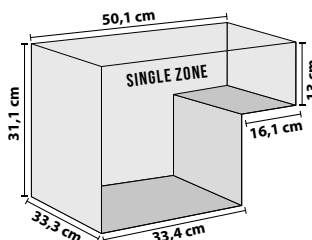
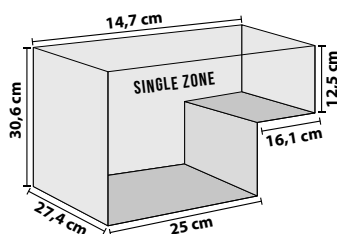



POLARYS HOME

MINI FRIDGE

42ℓ



POLARYS HOME

ART. 0826058N

€ TBC
1/1/6

45,3 x 45 x 49,5 cm

14,1 kg

240V

75W

42ℓ



REVERSE DOOR DESIGN MAKES DOOR OPENING MORE FLEXIBLE



FREEZER 4ℓ



Il mini-frigo compatto Polarys Home è la soluzione ideale per gli spazi ridotti come tende da sole, case mobili o case di vacanza. Ha una capacità di 42 litri e offre spazio per tutti gli alimenti e le bevande importanti. La cella frigorifera integrata con capacità di 4 litri è ideale per la conservazione a breve termine di carne e pesce freschi. Il ripiano della porta offre spazio per bottiglie da 2 litri e il pratico portaoggetti mantiene in ordine l'interno. Il frigorifero ha una temperatura regolabile (0°/10°) che può essere adattata in modo ottimale alla temperatura ambiente. È classificato nella classe climatica N-ST. Il frigorifero è piacevolmente silenzioso e ha un livello di rumorosità minimo di 43 dB. È dotato di una cerniera della porta intercambiabile che ne consente l'integrazione in qualsiasi ambiente. Il robusto alloggiamento in plastica garantisce una lunga durata.



POLARYS TRAVEL

COOLER BOXES



25ℓ **F** **A**
G



28ℓ **E** **A**
G



POLARYS TRAVEL 25

ART. 0826042N

€ TBC
1 / 1 / 24

30 x 39 x H40,7 cm

4 kg

12V DC/240V AC

P 48 W

V 25 l

Frigobox termoelettrici (sistema Peltier), alimentati mediante accendisigari da auto 12V DC oppure da rete 240V AC. Leggero e facilmente trasportabile. Ideali per la spiaggia, il picnic ed il campeggio.

CARATTERISTICHE:

- Con cavo di collegamento per funzionamento a 12V o 240V
- Adatto per bottiglie da 1,5 l / 2 l
- Coperchio chiudibile con maniglia
- Coperchio elettrico con sistema di raffreddamento integrato
- Facile posizionamento del frigobox in quasi tutti i bauli delle auto o dietro il sedile del conducente o del passeggero

POLARYS TRAVEL 28

ART. 0826044N

€ TBC
1 / 1 / 22

30 x 39 x H45,7 cm

4,5 kg

12V DC/240V AC

P 48 W

V 28 l



OPTIONAL

COOLPOWER

ART. 0826098N

€ TBC
5 / 30 / -

13,5 x 5,5 x 3 cm

330 g

100V / 240V - 50/60Hz - AC

P 72W



Alimentatore 220/12V per frigobox termoelettrici. Tensione in entrata: 240V / 50Hz. Tensione in uscita 12V DC - 6A.



FRIOBAGS

COLLECTION



12ℓ



20ℓ



30ℓ



34ℓ



FRIOBAG COMPACT

ART. 0824041N

€ TBC
10 / 10 / -

34 x 23 x 8,5 cm

100% Polyester Jacquard 420D

12 l

250 g

FRIOBAG DAYPACK

ART. 0824013N

€ TBC
4 / 4 / 120

30,5 x 18 x 46,5 cm

100% Polyester Jacquard 420D

20 l

800 g

FRIOBAG OBLIQUE

ART. 0824015N

€ TBC
4 / 4 / 96

45 x 25 x 33 cm

100% Polyester Jacquard 420D

30 l

850 g

FRIOBAG CLASSIC

ART. 0824016N

€ TBC
4 / 4 / -

34 x 31 x 33 cm

100% Polyester Jacquard 420D

34 l

900 g



AZO^{free}

Borse termiche di alta qualità, ideale per gite, spiaggia e picnic.



GELBAG

COLLECTION



GELBAG 20

ART. 0824047N

€ TBC
5 / 10 / -

36 x 23 x H31 cm

Polyester - PEVA

20 l

530 g

GELBAG 30

ART. 0824048N

€ TBC
5 / 10 / -

41 x 26 x H34 cm

Polyester - PEVA

30 l

600 g

Sia che trascorriate il vostro tempo libero a un picnic, in spiaggia, in viaggio o a una festa, i nuovi Brunner Gelbag sono caratterizzati da un isolamento in schiuma di alta qualità che mantiene cibi e bevande piacevolmente freschi per molte ore. Il rivestimento interno, trattato con microbatteri, è facile da pulire in qualsiasi momento ed è altresì resistente alla formazione di odori, muffe e funghi.

CARATTERISTICHE:

- Design moderno e funzionale
- Parte anteriore con pratica daisy chain
- Schiuma di alta qualità per un efficace isolamento
- Ampio scomparto principale con cerniera per alimenti e bevande
- Tracolla regolabile per un comodo trasporto a mani libere
- Maniglie laterali imbottite
- Incluso apribottiglie
- Fodera interna trattata con antimicrobico per prevenire la formazione di odori, muffe e funghi



BPAfree

PFOAfree



ICE PACK 140

Mini mattonelle di ghiaccio sintetico con involucro in materiale plastico. Perfettamente adatte per mantenere freschi e trasportare cibi e bevande in borse termiche, ghiacciaie o contenitori alimentari in genere. Riutilizzabili senza limite. Non contengono metalli pesanti o ftalati.

COOLPAD 200

Mattonella di ghiaccio sintetico dalla forma extra-piatta. Contenuto: refrigerante non pericoloso.

COOLPAD 400



					PACK	€ TBC	M.O.	Master	
ICE PACK 140	ART. 0826016N	12 x 12 x 1,3 cm	120 ml	4x 140 g	4X	€ TBC	18	18	-
COOLPAD 200	ART. 0826018N	16,5 x 11 x H1,5 cm	200 ml	2x 180 g	2X	€ TBC	12	24	-
COOLPAD 400	ART. 0826019N	25 x 14 x H1,5 cm	400 ml	1x 375 g	1X	€ TBC	12	24	-



INOX

Stainless Steel



FOSTER

ART. 0820028N

€ TBC
6 / 24 / -

365 g
 600 ml

Bottiglia termica infrangibile realizzata in acciaio inox alimentare 18/8. 100% BPA-free.

SHOT

ART. 0820055N

€ TBC
12 / 24 / 240

280 g
 750 ml

Bottiglie portabevande in acciaio alimentare verniciato a polvere. Con tappo a vite a filetto interno e coperchio rivestito in elegante bambù. Inodore ed insapore. Lavabile in lavastoviglie.

HYDROLIN STEEL 1000

ART. 0820026N

€ TBC
6 / 24 / 168

190 g
 1000 ml

Bottiglia in acciaio inox con elegante superficie lucidata.

LEGEND OUTDOOR 500

ART. 0820050N

€ TBC
12 / 24 / 192

270 g
 500 ml

Bottiglia termica realizzata interamente in acciaio inox antiurto.

LEGEND OUTDOOR 1000

ART. 0820051N

€ TBC
12 / 24 / 192

470 g
 1000 ml

IQUID

ART. 0820034N

€ TBC
6 / 12 / 180

Ø 11 x H31 cm
 900 g
 1,5 l

Bottiglia termica a doppia parete isolante realizzata in acciaio inox alimentare 18/8. 100% BPA-free.





18ℓ

SPECTRACOOL 18

ART. 0824038N.C9N

€ TBC
6 / 6 / 90

✂ 33 x 21 x 29 cm

🔲 700D Nylon / Alu foil

✓ 18 l

📖 1 kg



AZOfree

Borsa termica ideale per le giornate in spiaggia.

COLORS



ASSORTED



25ℓ

SPECTRACOOL 25

ART. 0824039N.C9N

€ TBC
6 / 6 / 60

✂ 45 x 27 x 27 cm

🔲 700D Nylon / Alu foil

✓ 25 l

📖 1,10 kg



AZOfree

Borsa termica ideale per le giornate in spiaggia.

COLORS



ASSORTED



FOLD-AWAY GLASS

ART. 0830410N

€ TBC
10 / 200 / -

✓ 200 ml

✂ Ø 8 x 1,5/8 cm

COLORS



FOLD-AWAY

Bicchiere pieghevole in silicone.



FOLD-AWAY FUNNEL

ART. 0830414N

€ TBC
12 / 36 / 576

✂ Ø 12 x 4/13,5 cm

COLORS



FOLD-AWAY

Imbuto pieghevole in silicone.



ELECTRICAL PRODUCTS

**PRODOTTI ELETTRICI AC E DC
SPOT E PLAFONIERE
ADATTATORI E PROLUNGHE**



ONBOARD 15



POWER BUTTON ON / OFF



12 LED LIGHT



RESIDUAL CURRENT DEVICE
MINIATURE CIRCUIT BREAKER



USB PORTS



3 X 230 V SOCKET (EU)



75  LED

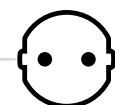

ONBOARD 15

ART. 0301069N

€ TBC
2 / 4 / 48

 63,5 x 41,5 x 35,3 cm + Cable 15 m

 4,25 kg

 75



L'avvolgicavo CEE con lampada integrata per campeggio e hobby è l'accessorio essenziale per i tuoi momenti all'aperto! Questo prodotto è dotato di un cavo lungo 15 metri, perfetto per coprire diverse distanze. La presa di sicurezza integrata offre protezione da sovraccarichi, garantendo la tua sicurezza. Inoltre, le 3 prese Schuko e i 2 port USB permettono di collegare facilmente tutti i dispositivi elettrici ed elettronici. Con un corpo in plastica rinforzata resistente alle intemperie, questo avvolgicavo è compatto e leggero, ideale da trasportare ovunque. Pratico, affidabile e pronto per l'avventura, l'avvolgicavo CEE con lampada integrata è il tuo alleato perfetto per le attività Outdoor.



ZING

Invertitori di corrente per veicoli ricreazionali, auto, barche e sistemi ad energia alternativa. Inverter a onda sinusoidale modificata.



Fusibile

Collegamento cavi



Schuko USB: 5V-3,1A On / Off Schuko



Ventola di raffreddamento



Collegamento cavi



Ventola di raffreddamento

CARATTERISTICHE:

- Tensione nominale in uscita: AC230V ± 10%
- Frequenza nominale in uscita: 50Hz ± 3Hz
- USB: 5V-3,1A
- Protezione tensione minima
- Protezione corto circuito



M.O.



Master

ZING	ART.	Dimensioni (cm)	Peso (kg)	Tensione DC (V)	Potenza (W)	Prezzo (€)	M.O.	Master
ZING 300	ART. 0826060N	16 x 15,5 x 7,5	868 g	10V-15V DC	300W	€ TBC	2	6 180
ZING 600	ART. 0826061N	19 x 15,5 x 7,5	1 kg	10V-15V DC	600W	€ TBC	2	6 180
ZING 1200	ART. 0826062N	25,5 x 15,5 x 7,5	1,5 kg	10V-15V DC	1200W	€ TBC	2	6 108



BEST SELLER

VENTO ELECTRONIC

ART. 7164010N

€ TBC
6 / 24 / 480

26 x 10 x 2,4 cm

370 g

12V - 0,5A

6W

Ventilatore per frigo a velocità variabile, regolata elettronicamente. Completo di pannello di comando.



VENTO NG 92

ART. 7164011N

€ TBC
6 / 12 / 288

19,2 x 9,2 x 3 cm

350 g

12V - 0,5A

VENTO NG 120

ART. 7164012N

€ TBC
6 / 12 / 216

24,8 x 12 x 3 cm

460 g

12V - 0,5A

Ventilatore per frigo ad alte prestazioni con pannello di controllo (completo di cornice per montaggio a parete). Il rilevamento della temperatura avviene mediante uno speciale sensore. Le staffe di fissaggio ed i cavi collegamento sono compresi nella fornitura.



VENTO SWIFT 92

ART. 7164006N

€ TBC
6 / 12 / 288

19,2 x 9,2 x 3 cm

350 g

12V - 0,5A

VENTO SWIFT 120

ART. 7164007N

€ TBC
6 / 12 / 216

24,8 x 12 x 3 cm

460 g

12V - 0,5A

Con il Vento Swift, il ventilatore per frigoriferi è stato completamente reinventato. Il cablaggio del pannello di controllo è stato interamente eliminato e un semplice collegamento all'alimentazione a 12V di bordo è tutto ciò che serve per avviare il dispositivo. Il pannello di controllo, che è dotato di un display touch screen a batteria, consente di utilizzare comodamente tutte le impostazioni della ventola e può essere montato in modo flessibile in qualsiasi punto del veicolo.





W8 2.0

La versione 2.0 della popolare W8-Gascontrol presenta i seguenti miglioramenti ed ottimizzazioni:

- Nuova copertura sviluppata per le celle di carico
- Prolungamento dei cavi di collegamento al vano di ricarica della batteria
- App W8 rivisitata

Il dispositivo elettronico W8 GASCONTROL misura il livello di riempimento delle bombole a gas e lo trasmette via Bluetooth a Smartphone o Tablet con tecnologia Android o iOS. Grazie alla sua altezza molto contenuta il W8 GASCONTROL può essere utilizzato in maniera continuativa nel vano portabombole della stragrande maggioranza di veicoli ricreazionali.



Smartphone not included

APP: W8 SYSTEM



W8 2.0

ART. 0712005N

€ TBC
1/4 / 144

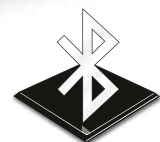

Ø 29,2/31 x H3,2/4,1 cm



CARATTERISTICHE:

- Adatto per tutte le bombole gas (acciaio, alluminio, plastica, vetroresina) con diametro massimo di 30 cm
- Misurazione rapidissima del livello di riempimento
- Indicazione dell'autonomia
- Lettura del livello di riempimento e dell'autonomia su Smartphone o Tablet
- Tecnologia Bluetooth
- Software compatibile con sistemi Android e iOS
- App per Smartphone o Tablet inclusa (download)
- Funzionamento a batterie (non ricaricabili)
- Involucro in resistente materiale plastico
- Semplice e intuitivo da usare
- Prodotto europeo

CAMPI D'UTILIZZO:

- Veicoli ricreazionali
- Camping e picnic
- Barbecue & grill

ATTENZIONE: IL DISPOSITIVO DI LETTURA (SMARTPHONE, TABLET, ECC.) NON È INCLUSO NELLA FORNITURA!

INFO

La versione 2.0 della popolare W8-Gascontrol presenta i seguenti miglioramenti ed ottimizzazioni:

- Nuova copertura sviluppata per le celle di carico
- Prolungamento dei cavi di collegamento al vano di ricarica della batteria
- App W8 rivisitata



AREAS OF APPLICATION:



GLOBETRACKER360

ART. 0712001N

€ TBC
1/4/-

-  9,8 x 9,8 x 3,0 cm
-  150 g
-  12V DC / 230V AC



L'obiettivo di questo progetto è quello di realizzare un sistema di monitoraggio dei parametri di sicurezza di base dell'abitacolo del veicolo ricreazionale e di fornire un sistema di allarme valido, semplice da installare e facile da usare.

CARATTERISTICHE:

- Unità centrale: Alimentazione variabile da 9 a 30 Vdc tramite presa accendisigari o trasformatore
- Lettura temperatura/umidità ambiente
- Lettura gas CO2 e GPL (con possibilità di attivazione dell'allarme in caso di superamento della soglia di allarme)
- Posizione GPS (con possibilità di allarme se il veicolo si muove al di fuori di un'area consentita)
- Possibilità di collegare fino a 5 satelliti per la gestione degli allarmi antintrusione
- Contatto magnetico radio con codice di comunicazione proprietario per allarme apertura porte o finestre
- Sistema di rilevazione di presenza via radio con codice di comunicazione proprietario per allarme di presenza
- Batteria di backup per mancanza di corrente
- Cicalino di allarme e LED di stato



HUB



VOLUMETRIC-MOTION SENSOR



MAGNETIC CONTACT SENSOR



GLOBETRACKER360 APP



3-SICUR

ART. 0712002N

€ TBC
2/10/-

-  7 x 11 x H4 cm



Dispositivo di rilevazione gas per veicoli ricreazionali dotato di sensore ad alta sensibilità in grado di rilevare propano/butano, monossido di carbonio e gas narcotizzanti. Il dispositivo si calibra automaticamente ed in caso di allarme emette un segnale acustico. Una batteria tampone (non inclusa) garantisce la funzionalità del dispositivo anche in caso di mancanza di alimentazione di bordo. 3-Sicur, può essere utilizzato in modo mobile o con installazione permanente. E' dotato di un solo pulsante per accensione, spegnimento, test e reset, luci a led di segnalazione a led e spina a 12V.



Goditi il massimo comfort in viaggio con il nostro sistema di aria condizionata portatile a split per veicoli ricreazionali e caravan! Che tu stia viaggiando in camper, roulotte o furgonato, la nostra unità AC a split ti offre una temperatura interna piacevole durante ogni viaggio. Con le sue dimensioni compatte e l'installazione facile, si adatta perfettamente al tuo veicolo, garantendo un clima rinfrescante non importa quanto sia caldo all'esterno. La tecnologia a split offre un raffreddamento efficiente senza rumore o vibrazioni, permettendoti di godere di pace e relax. Il nostro sistema di aria condizionata è energetico ed ecologico, in modo da poter non solo migliorare il tuo comfort, ma anche preservare la natura. Affronta le tue avventure con il lusso e la comodità del nostro sistema di aria condizionata portatile a split per veicoli ricreazionali e roulotte!

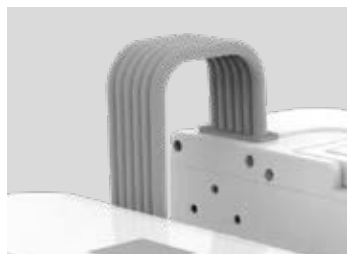

Connecting hose



**Exhaust air
Air outlet opening**



Air outlet



Display Led

THE FOLLOWING OPERATING MODES CAN BE SELECTED



Fan



Cooling



Dehumidification



Sleep



Swivel

**Air flow rate
280 m³/h**

**Dehumidification
capacity 0.5 l/h**



POLARYS TWINAIR

COLLECTION



Night Mode



Super Silent



2 Ventilation Levels



Touch Control



EASY INSTALLATION
Mounting Frame included

POLARYS TWINAIR 3

ART. 0716031N

€ TBC
1/1/6

44,5 x 31 x 19 cm + 44 x 35,5 x 21 cm

5,6 kg + 14,4 kg

230V - 50Hz - 345W

3000 BTU (900W)



POLARYS TWINAIR APP

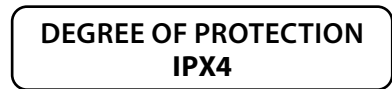
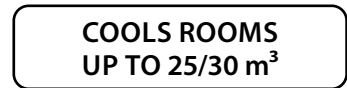

Il nuovo condizionatore d'aria Polarys Twinair split è la soluzione perfetta per chi vuole godere di un piacevole raffreddamento nel proprio veicolo ricreazionale nelle giornate e nelle notti più calde. Il condizionatore è facile da installare e da utilizzare e può essere impiegato praticamente in qualsiasi veicolo. Come suggerisce il nome, il condizionatore Polarys Twinair split è composto da due parti: un condensatore e un evaporatore. Il condensatore si trova all'esterno del veicolo e l'evaporatore all'interno. Le due parti sono collegate da un tubo flessibile. L'installazione del condizionatore è semplice e può essere effettuata in pochi minuti. Grazie alla moderna tecnologia, il climatizzatore Polarys Twinair split è molto efficiente e consuma pochissima elettricità. Il condizionatore ha una capacità di raffreddamento di 3000 BTU (900W) e mantiene fresche stanze fino a 25/30 m³. Questo lo rende ideale per l'uso mobile nei veicoli ricreazionali o nelle case mobili.

VANTAGGI:

- Facile installazione
- Silenzioso
- Efficiente
- Raffredda ambienti fino a 25/30 m³
- Due livelli di ventilazione
- Con controllo remoto tramite APP.



POLARYS TWINAIR 5 H&C



THE FOLLOWING OPERATING MODES CAN BE SELECTED



Fan



Cooling



Dehumidification



Heating



Swivel

Air flow rate
280 m³/h

Dehumidification
capacity 0.5 l/h



Δt 16 - 30 °C

COOLS ROOMS
UP TO 25/30 m³

DEGREE OF PROTECTION
IPX4



POLARYS TWINAIR
APP









POLARYS TWINAIR 5 H&C

ART. 0716033N

€ TBC
1/1/6

-  45,4 x 29,8 x 17 cm + 45,4 x 33,0 x 20,5 cm
-  19,5 kg
-  230V - 50Hz - 560W
-  5000 BTU (1460W)



La soluzione più avanzata per mantenere la vostra roulotte o il vostro camper freschi o confortevolmente caldi. Questo sistema, facile da installare, si inserisce direttamente nel finestrino del veicolo, offrendo un sollievo immediato dal caldo. Dite addio alle notti appiccicose e ai viaggi scomodi, e date il benvenuto a un'aria fresca e rigenerante. Il nostro sistema di climatizzazione è stato progettato specificamente per caravan e camper, in modo da soddisfare tutte le vostre esigenze. È compatto, efficiente dal punto di vista energetico e facile da usare, il che lo rende l'aggiunta perfetta a qualsiasi veicolo ricreativo.

CARATTERISTICHE:

- Funzione di raffreddamento e riscaldamento
- Design moderno e funzionale
- Display digitale
- Maniglia di trasporto integrata



Night Mode



Super Silent



2 Ventilation Levels



Touch Control



EASY INSTALLATION
Mounting Frame included





MISTRAL UNIVERSAL

ART. 0716020N

€ TBC
4 / 12 / 96

-  Ø 22cm
-  0,7 kg
-  12V







Potente ventilatore a 12V con doppio sistema di fissaggio (piastra a vite o fissaggio a clip). Griglia di protezione cromata Ø 22cm. Collegamento elettrico tramite presa accendisigari.



ATMO RG

ART. 0716014N

€ TBC
4 / 8 / 168

-  Ø 22 x H13 cm
-  480 g
-  3,7V / 4000mAh RG Li-Ion
-  80 lumen
-  1
-  12h Light / 7h Fan

Questa pratica combinazione di ventilatore/lampada ricaricabile fornisce simultaneamente una luce LED brillante e la brezza fresca di un potente ventilatore a quattro pale. Il design funzionale permette il fissaggio del ventilatore sia al tetto che alle pareti di tende e verande mediante la sua maniglia pieghevole e/o il suo gancio.

CARATTERISTICHE:







- 2 livelli di luminosità
- Ventilatore a 4 pale in schiuma espansa (a prova di infortunio) - 2 velocità
- Utilizzabile in 3 posizioni: appeso verticalmente, appeso orizzontalmente, appoggiato ad una superficie piana



MOONBELLE RG

ART. 0716015N

€ TBC
5 / 10 / 240

-  18,2 x 18 x 9 cm
-  442 g
-  3,7V Li-Ion - 4000mAh
-  60 lumen
-  48
-  18h - 36h





Ventilatore ricaricabile per esterni con luce LED dal moderno design a due colori, tre velocità regolabili e diverse impostazioni di luminosità, per garantire un comfort ottimale. Dotato di un comodo gancio per appenderlo, questo ventilatore può essere facilmente attaccato a tende o tettoio, ma può anche rimanere in posizione autonoma. Con una batteria da 4000 mAh e un tempo di ricarica di 2 ore, offre una circolazione d'aria continuativa. Si collega a un alimentatore mobile, a un computer o a un adattatore per telefono grazie all'alimentazione USB.



SCIROQUE 2.0

ART. 7202814N

€ TBC
6 / 24 / 576

-  14,3 x 5 x 19 cm
-  300 g
-  220V + 110V AC
-  800W

Asciugacapelli compatto con maniglia pieghevole salvaspazio. Può essere utilizzato sia con una tensione di 230V, che con 110V. Corpo in resistente materiale plastico. Con pratica borsa portaoggetti.



THYFAN RG

ART. 0716010N

€ TBC
6 / 6 / -



HURRIFAN RG

ART. 0716012N

€ TBC
6 / 6 / -



- 20 x 20 x 30/66 cm
- 16,5 x 16,5 x 8,5 cm
- 520 g
- 4000mAh Li-Ion
- 50 lumen



- Ø 21 x 35/88 cm
- Ø 21 x 7,5 cm
- 520 g
- 7200mAh Li-Ion
- 6-24 h



Questo ventilatore telescopico da esterno ricaricabile, compatto e versatile, è il complemento ideale per le vostre vacanze Outdoor. Le sue potenti impostazioni a 3 velocità assicurano una brezza rinfrescante, mentre il funzionamento silenzioso vi permette di godere della tranquillità della natura. Il treppiede staccabile offre opzioni di posizionamento versatili e l'angolo regolabile assicura che il flusso d'aria sia diretto esattamente dove serve. La luce ambientale a LED incorporata aggiunge un tocco accogliente e il design compatto lo rende facile da riporre e trasportare. Realizzato con materiali di alta qualità, questo ventilatore è costruito per resistere ai rigori dell'uso all'aperto, fornendo prestazioni affidabili stagione dopo stagione.

Ventilatore ricaricabile con sistema telescopico estraibile e potente flusso d'aria. Portatile, pieghevole e facile da trasportare e riporre. Testata del ventilatore con regolazione dell'angolo a 180° e tre impostazioni di velocità di ventilazione per un comfort ottimale. Utilizzabile fino a 24 ore grazie alla batteria integrata di grande capacità da 7200 mAh. Perfetto per l'uso in ambienti interni o esterni.

CARATTERISTICHE:

- Capacità di lavoro continuo: alta velocità 6 ore, velocità silenziosa 24 ore
- Qualità premium: Questo ventilatore è realizzato con i materiali ABS e PP più resistenti per un uso prolungato
- Connessione USB



MONSUN

ART. 7202818N

€ TBC
6 / 12 / 384

- 15 x 7 x H18 cm
- 18,5 x 7 x H10,5 cm
- 320 g
- 12V DC
- 120W

Utilissimo asciugacapelli 12V da viaggio. Design moderno con manico pieghevole salvaspazio. Involucro in resistente materiale plastico. Completo di interruttore ON/OFF, spina per accendisigari e becco per la piega staccabile. La fornitura comprende una pratica custodia per il trasporto.



SOFFIO

ART. 7202816N

€ TBC
6 / 24 / -

- 15,82 x 6,69 x 22,43 cm
- 370 g
- 220V
- 1100W-1300W

IONE FUNCTION



L'asciugacapelli da viaggio Soffio è il compagno perfetto per la vostra routine di bellezza in movimento. Progettato con un look moderno ed elegante, questo asciugacapelli presenta un corpo elegante e rifinito in gomma, facile da impugnare e maneggiare. Il motore ad alta potenza offre una forte forza di soffiaggio, consentendo di asciugare i capelli in modo rapido ed efficiente. Con 2 impostazioni di velocità e calore, è possibile personalizzare il flusso d'aria e la temperatura in base al tipo di capelli e alle esigenze di styling. L'ugello concentratore incluso aiuta a dirigere il flusso d'aria per uno styling preciso.



ASPAIR DUAL NG



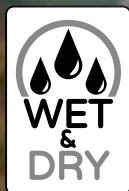



VACUUM CLEANER



ASPAIR DUAL NG

ART. 0436025N

€ TBC
1 / 4 / 72

-  12 x 41/122 x 12 cm
-  1 kg
-  Li-Ion 2000 mAh / 11,1 V
-  100 W / 5,5 kPa
-  500 ml (powder) / 120 ml (liquids)
-  13 min



13 min.



5,5 h



Il potente aspirapolvere Aspair Dual NG è lo strumento ideale per rimuovere qualsiasi tipo di sporco e/o liquido. Grazie al suo design molto maneggevole e compatto, è possibile pulire in poco tempo anche luoghi difficili da raggiungere. Piccoli e grandi residui di sporco vengono facilmente rimossi grazie alla sua grande potenza di aspirazione ed il vostro veicolo, la veranda o il tavolo da pranzo tornano puliti in pochissimo tempo. Utilizzabile perfettamente anche come aspirapolvere da pavimento per mezzo dei tubi di prolunga inclusi nella fornitura.





CARATTERISTICHE:

- Ricaricabile: Batteria Li-ion (funzionamento cordless) con indicatore di carica
- Potenza di aspirazione 5,5 kPa con potente motore a turbina
- Aspirazione a secco e a umido
- Facile da maneggiare grazie al peso ridotto di soli 1,0 kg
- Ricarica tramite caricabatterie 230V o cavo di ricarica 12V (180 cm)
- Filtro HEPA lavabile
- Pulizia a tutto campo: con 4 diversi tipi di accessori
- Inclusi nella fornitura: bocchetta per fessure, spazzola per pulire, spazzola rotonda, bocchetta per liquidi, tubi di prolunga, custodia per il trasporto
- Funzionamento silenzioso
- Capacità del contenitore di 500 ml di polvere o 120 ml di liquido
- Docking station (indipendente e a parete)

VORTIX

ART. 0436020N

€ TBC
6 / 12 / 72

-  Ø 22 x H24 cm
-  1,3 kg
-  12V
-  75W / 6,4A



Aspirapolvere ed aspira acqua a corrente continua con struttura in robusto materiale plastico, tubo flessibile e lungo cavo di alimentazione a 12V. Accessori inclusi: bocchetto per fessure, bocchetto per tappeti, adattatore per gonfiaggio.



VACUUM
MODE



INFLATION
MODE



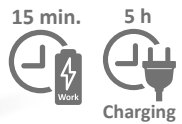

POTENTIA

ART. 0436022N

€ TBC
1 / 4 / -

42,0 x 10,5 x 16,0 cm

1,3 kg

2000mAh

120W

320 ml

Aspiratore ricaricabile ad alte prestazioni per camper, barca e auto, con un potente sistema di filtraggio multiciclonico con filtro HEPA, che assicura ogni volta una pulizia profonda e accurata. Il design elegante e modulare consente di smontare e pulire facilmente l'aspirapolvere, mentre i pratici indicatori di carica e di batteria vi tengono informati sullo stato dell'aspirapolvere. Con due comode impostazioni di potenza, è possibile affrontare una varietà di situazioni con facilità ed efficienza.

CARATTERISTICHE:

- Il corpo principale e il serbatoio della polvere possono essere smontati per una facile pulizia
- Indicatore di carica e indicatore di carica della batteria



TEMPEST RG USB

ART. 0436016N

€ TBC
10 / 20 / -

8 x 7,5 x 10,5 cm

280 g

RG

38 W

l/min 270 l/min



Potente pompa 5V con interruttore ON-OFF. Completa di adattatore USBC. Con borsa.



AIRTOUCH NG

ART. 0436015N

€ TBC
2 / 10 / -

15 x 15 x 8 cm

1,32 kg

2600mAh x 3

150PSI



Compressore portatile wireless ricaricabile con batteria agli ioni di litio e presa USB per la ricarica. Dotato di display digitale Touch Screen. Ideale per essere utilizzato ovunque sia richiesto senza la necessità di avere nelle vicinanze una presa elettrica dove collegare il cavo di alimentazione. Perfetto per gonfiare auto, moto, biciclette e palloni.

CARATTERISTICHE:

- Corpo in resistente materiale plastico
- Display digitale
- Batteria agli ioni di litio 2500 mAh
- Presa USB per la ricarica
- Cavo di alimentazione/ricarica USB - lunghezza 1,5 m
- Con adattatore 5V DC / 1A
- Tubo aria in gomma con connettore a sgancio rapido. Lunghezza 60 cm
- Completo di 2 adattatori ed 1 ago sportivo





MINUWATT

INFO P. 356

SERIES



CALENSA

ART. 7202842N

€ TBC
6 / 6 / 144



18 x 15 x 19 cm

1,17 kg

220V - 240V - 50/60 Hz

750W - 1500W



Nuovissimo termoventilatore compatto in ceramica, con elemento riscaldante PTC. Corpo in solido materiale plastico, ideale per l'uso in caravan, camper o verande, è dotato di regolatore termostatico.

CARATTERISTICHE:

- Potenza variabile da 750 a 1500 Watt
- Termostato regolabile
- Fusibile di sicurezza
- Interruttore antiribaltamento
- Protezione da surriscaldamento

KERO THERMOSTAT

ART. 7202840N

€ TBC
6 / 12 / 276



15,5 x 15 x H7,3 cm

650 g

230V

500W DC



Termoventilatore compatto in ceramica con elemento riscaldante PTC. Corpo in solido materiale plastico. Ideale per l'uso in caravan, camper o verande. Dotato di un regolatore termostatico. Il ventilatore integrato garantisce un'efficiente distribuzione del calore.

CARATTERISTICHE:

- Protezione anti-surriscaldamento
- Protezione anti-ribaltamento
- Controllo termostatico
- Adatto a locali fino a 10 m²



SOLAN

ART. 7202839N

€ TBC
6 / 6 / 108

21 x 14 x 16 cm

1,5 kg

230V AC - 50Hz

750W / 1500W

Potente stufetta elettrica a ceramica. Utilizzabile anche come ventilatore.

CARATTERISTICHE:

- Involucro in resistente materiale plastico
- Temperatura regolabile senza scatti
- Resistenze in ceramica PTC
- Non brucia la polvere
- Protezione anti-surriscaldamento
- Protezione anti-ribaltamento









NEW
2025

INCANTE

ART. 7202850N

€ TBC
6 / 6 / -

-  24,2 x 13,9 x 23,9 cm
-  1,2 kg
-  220V - 240V - 50/60 Hz
-  750W - 1500W

MINUWATT SERIES



Il riscaldatore elettrico a ventola Incante è una soluzione di riscaldamento versatile ed efficiente che offre comfort e convenienza. Con due impostazioni di calore, 750W e 1500W, è possibile regolare facilmente il calore in base alle proprie esigenze. Il funzionamento a 230 V garantisce un'alimentazione affidabile e costante. Questa stufa offre una gamma di opzioni per la temperatura dell'aria, da normale a calda a calda, consentendo di creare l'ambiente perfetto. Il termostato regolabile consente di mantenere la temperatura desiderata, mentre la funzione di protezione dal surriscaldamento garantisce un funzionamento sicuro. La spia di accensione e la maniglia per il trasporto migliorano ulteriormente il design di facile utilizzo. Realizzato con un'estetica moderna, questo termoventilatore elettrico è un'aggiunta elegante e pratica a qualsiasi casa o ufficio.

CARATTERISTICHE:

- Aria normale/calda/calda da selezionare
- Verticale o orizzontale
- Termostato regolabile
- Protezione contro il surriscaldamento
- Indicatore luminoso di potenza
- Maniglia per il trasporto
- Design moderno
- Dimensioni compatte



NEW
2025

BLACKFIRE

ART. 7202851N

€ TBC
6 / 24 / -

-  14,8 x 13 x 8,5 cm
-  380 g
-  12V
-  120W

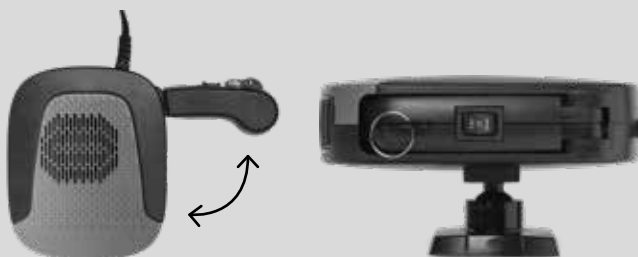

Termoventilatore funzionante a 12V DC. Molto efficiente, con base rotante per cruscotto e interruttore integrato per commutazione da stufetta a ventilatore. Dotato di pratico manico pieghevole a scomparsa per utilizzarlo come sbrinatori. Connessione elettrica tramite spina per accendisigari. Montaggio a vite o mediante piastrine biadesive incluse. Il cavo di collegamento è incluso nella fornitura.



HOT POINT

MINU WATT

SERIES

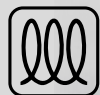

Induction



HOT POINT INDUCTION

ART. 7202834N

€ TBC
6 / 6 / 72

 28 x 35 x H4,6 cm

 2,1 kg

 230V - 50Hz

 300 - 2000W



Touch Control

Piastra ad induzione di calore portatile con corpo in PP e superficie di cottura realizzata in vetroceramica ad alta resistenza. Perfetta per l'utilizzo in ambito Outdoor e Camping grazie al suo peso ridotto ed ai 9 livelli di potenza (300 - 2000 W) selezionabili mediante interruttore Touch Control e display LED.





Touch Control

HOT POINT DOUBLE INDUCTION

ART. 7202835N

€ TBC
1 / 1 / 30

 57,8 x 36,8 x 4,5 cm

 4,6 kg

 230V - 50Hz

 3500W (1800W + 1700W)

Fornello elettrico portatile a induzione con doppia piastra: la soluzione perfetta per l'uso all'aperto e il campeggio. Ha un design ultrapiatto con un alloggiamento resistente al calore e una superficie di cottura in vetroceramica altamente resistente. Le due zone di cottura hanno ciascuna 9 livelli di potenza (la zona di sinistra da 300W a 1800W mentre la zona di destra da 300W a 1700W), selezionabili tramite controllo touch e display a LED. Il fornello è facile da trasportare e da riporre e occupa pochissimo spazio. Inoltre è molto efficiente e consuma poca elettricità.

VANTAGGI:

- Portatile e poco ingombrante
- Resistente al calore
- Materiali di alta qualità
- 2 zone di cottura con 9 livelli di potenza
- Facile da usare
- Efficiente dal punto di vista energetico

HOT POINT INDUCTION GRILL

ART. 7202833N

€ TBC
1 / 1 / 48

 37 x 27 x H4,8 cm - 41,5 x 27,2 x H3,3 cm (grill plate)

 3,9 kg

 230V - 50Hz

 300 - 2000W



GLASS CERAMIC



MINU WATT SERIES

LED DISPLAY



Fornello/Grill portatile elettrico dotato di monopiastra ad induzione. Costruzione solida e dal design moderno realizzata con corpo in PP termoresistente e superficie di cottura in vetroceramica ad alta resistenza. Ideale per l'utilizzo in ambito outdoor e campeggio, grazie a una zona di cottura con 9 livelli di potenza (da 300 a 2000W) selezionabili mediante comandi Touch control e display led. La fornitura comprende una piastra grill in alluminio predisposta per una termodiffusione omogenea, internamente rivestita in ceramica per delle cotture alla griglia davvero eccezionali.



HOT POINT

ART. 720283 1N.C25

€ TBC
6 / 6 / 144

 29,5 x 27 x H7 cm + Plate Ø 18,5 cm

 2 kg

 230V - 50 Hz

 750W

Piastra di cottura elettrica con corpo in metallo verniciato e manopola di selezione potenza a 5 posizioni.





INFO

MINUWATT SERIES

La collezione di prodotti Minuwatt è costituita da una serie di apparecchi elettrici con un fabbisogno energetico (watt) particolarmente ridotto.

Ciò significa che potrete utilizzare questi apparecchi senza limitazioni in tutti i campeggi, anche in quelli con scarsa alimentazione elettrica.

La nostra collezione Minuwatt offre un'ampia gamma di apparecchi di alta qualità, tra cui piastre elettriche, bollitori, tostapane, stufe e molto altro.

Ogni apparecchio è stato accuratamente progettato per essere efficiente dal punto di vista energetico, pur offrendo prestazioni ottimali.

Con gli apparecchi Minuwatt, potrete godervi appieno la vostra vacanza in campeggio senza preoccuparvi della potenza disponibile poiché si adattano perfettamente alla corrente fornita dai campeggi e vi permettono di vivere un soggiorno in campeggio comodo e conveniente.



MINUWATT KETTLE

ART. 7202844N

€ TBC
4/8/-

- 1,7l
- 22,7 x 15,7 x 23 cm
- 910 g
- 230V - 50Hz
- 750W



Il nuovo bollitore elettrico per i camper con alimentazione limitata! Grazie al suo ridotto consumo energetico, questo bollitore consente di riscaldare facilmente l'acqua per il caffè, il tè o altre bevande calde senza sovraccaricare la fonte di alimentazione. Resistente ed efficiente, questo bollitore è un must per ogni camperista.



MINUWATT TOASTER

ART. 7202848N

€ TBC
3/6/-

- 28,3 x 16,9 x 18,5 cm
- 490 g
- 230V - 50Hz
- 780W - 930W



Il tostapane perfetto per i vostri viaggi in camper! Il nostro tostapane elettrico è costruito per ridurre l'assorbimento di energia, rendendolo ideale per l'uso in campeggi con bassa potenza. Questo tostapane è stato progettato per risparmiare energia senza sacrificare la funzionalità, garantendo una tostatura perfetta ogni volta. Rendete le vostre mattine ancora migliori con il nostro tostapane da campeggio efficiente e affidabile.



MINUWATT DYOMO

ART. 7202852N

€ TBC
4/4/-

- 29,5 x 25,5 x 19 cm
- 1,4 kg
- 220/240V - 50Hz
- 400W / 800W / 1000W
- 2,5l







Soluzione multifunzionale per la cottura senza fornello che ridefinisce la praticità in cucina. Con caratteristiche come il coperchio visibile per un facile monitoraggio, la distensione regolabile della testa e la manopola girevole in due modalità, questo cuocivande offre la possibilità di controllare con precisione le vostre creazioni culinarie.

CARATTERISTICHE:

- Capacità: 2,5l
- Modalità di riscaldamento: Interruttore di potenza a 2 livelli
- Materiale: PP, acciaio inox - fondo senza saldature
- Cavo: 1,00 m

VIVAMOCA

ART. 7202846N

€ TBC
4 / 16 / - 7,8 x 26,6 cm 4000mAh Li-Ion 150W 20 bar

Riscaldamento rapido ed estrazione automatica: Questa macchina da caffè espresso portatile utilizza la tecnologia di riscaldamento in ceramica ed eroga l'espresso (80?) in soli 3-4 minuti. La pressione di 20 bar garantisce un'estrazione perfetta delle capsule NS e del caffè macinato, offrendo un espresso ricco di crema e aroma. Compatibile con capsule NS e caffè macinato.

CARATTERISTICHE:

- Ricaricabile
- Pompa: 20 bar
- Capacità dell'acqua: 90-120 ml
- Dimensione dell'erogazione: 60-100 ml
- Con cavo di ricarica USB











RAY S

ART. 7530019N

€ TBC
5 / 50 / -







-  22,5 x 3 cm
-  160 g
-  12V DC
-  150 lumen
-  24
-  2,5W



RAY L

ART. 7530020N

€ TBC
5 / 50 / -

-  45 x 3,5 cm
-  296 g
-  12V DC
-  500 lumen
-  36
-  5W



180 DEGREE
SWIVEL

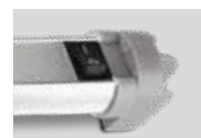

MINI ROCKER SWITCH

Lampada LED molto luminosa. Struttura in alluminio rotante.



AVENUE

ART. 7530059N

€ TBC
5 / 25 / -

-  37 x 5 x 5,5
-  280 g
-  12V
-  355 lumen
-  10
-  3W



Lampada LED per esterni ad alta luminosità. Corpo in resistente ABS. Precablata per un montaggio rapido. Angolo di diffusione: 40°.







358



ILUMINA LED 45

ART. 7530032N

€ TBC
4 / 16 / 320

-  45 x 3,8 x 4,2 cm
-  180 g
-  12V
-  350 lumen
-  36
-  4,3W









Luce esterna LED per illuminare l'ambiente circostante le porte d'entrata di veicoli ricreazionali. Il corpo realizzato interamente in alluminio, grazie alla sua speciale forma, facilita il deflusso dell'acqua piovana. Schermo in materiale plastico opacizzato per garantire la distribuzione uniforme della luce. Disponibile in 2 lunghezze.



ILUMINA LED 60

ART. 7530033N

€ TBC
4 / 16 / 320

-  60 x 3,8 x 4,2 cm
-  280 g
-  12V
-  630 lumen
-  66
-  6,7W



358



STELLA

ART. 0720025N

€ TBC
6 / 6 / -

3600mAh

600 lumen

6-12h

63 x 2

Ø 13 x 5,5 cm

250 g

4W



Lampada multifunzionale Outdoor che offre un'eccezionale versatilità e consente di utilizzarla in posizione verticale o appesa per un'illuminazione ottimale. Caratterizzata da un elegante design di colore bianco, la lampada è dotata di una base magnetica che consente di posizionarla comodamente su qualsiasi superficie metallica. Alimentata da una batteria ricaricabile, questa lampada a LED garantisce prestazioni affidabili e durature, rendendola il compagno perfetto per tutte le attività all'aperto.

CARATTERISTICHE:

- Utilizzabile come power bank
- Con cinghia per essere appesa e fissaggio magnetico
- 3 temperature di colore (3000/4000/6000 Kelvin)



3 LIGHTING MODES

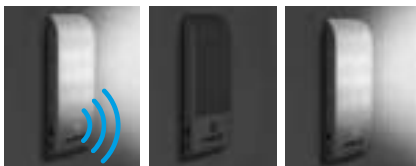

AUTO
MOTION SENSER
LIGHT

OFF
TURN LIGHT OFF

ON
ALWAYS LIGHTING

ATHOME

ART. 7530031N

€ TBC
10 / 100 / -

12 x 4,3 x 1,7 cm

80 g

Lithium 500mAh 3,7V

240 lumen

12

0,75W



Lampada ricaricabile LED per armadi, entrate, corridoi, dispense, ecc. Corpo in elegante materiale plastico con sensore di movimento a tecnologia PIR integrato. Facilmente ricaricabile mediante presa USB. Montaggio a parete.

AUTO - PASSIVE INFRARED (PIR)



360° ROTATION

180° ADJUSTABLE

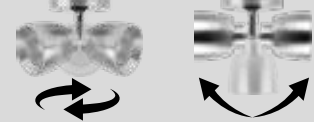

FUNKY LED HP

ART. 7530025N

€ TBC
5 / 50 / 450

Ø 6 x H10 cm

148 g

12V DC

140 lumen

1

3W



Spot LED montabile con riflettore orientabile.



FLEXSPOT LED

ART. 7530028N

€ TBC
5 / 50 / 800

Ø 6,5 x H18 cm

190 g

10-30V

650 lumen

1

3W



Faretto LED da parete con braccio snodato (10 cm) realizzato in metallo cromato e riflettore in alluminio con interruttore sensibile al tatto. Design moderno ed elegante.











SYRMA LED

ART. 7521018N

€ TBC
5 / 20 / 360

-  230 V
-  520 lumen
-  32
-  Ø 18,5 X H12 cm
-  350 g
-  15W



DIMMERABLE
0-100%

COLORS



C06

C34

Lampada LED per tende e verande. Corpo pieghevole in silicone (sistema Fold-Away).







CARATTERISTICHE:

- Corpo in silicone
- Moderna tecnologia LED per oscuramento graduale (dimmer)
- Con gancio di sospensione e cavo di collegamento da 5 m
- Sistema di regolazione dell'altezza
- Interruttore ON-OFF

GLOBE LED

ART. 0720009N

€ TBC
10 / 50 / 400

-  Ø 10,4 x H17,3 cm
-  180 g
-  3,7V 2400mAh
-  98-394 lumen
-  42
-  21W
-  8-15 h

Lampada LED a basso consumo energetico realizzata con corpo in resistente ABS e schermo in materiale plastico trans lucente che genera una luce uniforme. Il pulsante ON-OFF integrato permette di selezionare più livelli di intensità luce per illuminare l'ambiente circostante in maniera ottimale. Completa di gancio in metallo per appenderla e presa Micro-USB per la ricarica. Facile da trasportare grazie alle sue dimensioni compatte. Ottima per l'utilizzo Outdoor e Camping.



RECHARGEABLE





ZAZÀ



ZAZÀ DUO

ART. 0205081N

€ TBC
6 / 12 / -

-  230V AC
-  11 x 6 x 4,5 cm
-  60 g





NOT INCLUDED



ZAZÀ DUO 12V

ART. 0205083N

€ TBC
6 / 6 / -

-  9 x 5 x 4,5 cm
-  80 g
-  12V DC

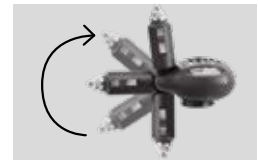

NOT INCLUDED







Insetticida elettrico a vaporizzazione con doppia configurazione. Dotato di spina rotante e interruttore ON/OFF. Liquido non incluso.

Insetticida funzionante sia con piastrelle tampone che con pratico vaporizzatore per liquidi insettifughi (non inclusi). Non produce fumo e protegge per 8 ore ca.

FIREFLY

ART. 0205085N

€ TBC
4 / 16 / 144

-  13,1 x 13,1 x H13,6 cm
-  600 g
-  5V DC
-  4W



Zanzariciller elettronico con lampada LED-UV e ventola di aspirazione incorporata.

CARATTERISTICHE:





- Sicuro ed ecologico: nessun bisogno di repellenti anti-zanzare tossici e malsani
- Nessun odore sgradevole o sibilo fastidioso generato dai sistemi a scossa elettrica
- Zona di aspirazione a 360°: le zanzare vengono attratte dalla luce a LED ed aspirate nel corpo rimovibile tramite il ventilatore aspirante incorporato
- Funziona con una tensione di 5V DC con connessione USB
- Compatto e leggero. Facile da trasportare e posizionare



MOSLIGHT

ART. 0205086N

€ TBC
6 / 24 / 528

-  8,7 x 8,7 x 13 cm
-  230 g
-  18650 RG (incl.)
-  3W



Praticissima lampada LED per Outdoor a doppia funzione luce/zanzariciller dotata di batterie al litio ricaricabili. Utilizzabile anche appesa mediante il gancio in metallo pieghevole integrato nell'involucro. Schermo in materiale plastico traslucido che trasmette una luce uniforme. Completa di cavetto USB di ricarica.

CARATTERISTICHE:

- Funzionamento mediante batteria ricaricabile 18650
- Corpo in resistente materiale plastico ABS/PC
- Resistente agli spruzzi
- Zanzariciller a luce UV (360-390 nm)
- Interruttore: ON-OFF (lampada)
- Interruttore ON-OFF (zanzariciller)
- Luce a 3 intensità selezionabili
- Presa Micro-USB



3in1



WITH UV LIGHT
360-390 NM



made in EU



B-SWITCH 12V

ART. 7203307C

€ TBC
6 / 12 / -

12V

PACK 1X

Staccabatteria 12V/24V per veicoli ricreazionali ed autovetture. Resistenza fino a 500 A. Chiave estraibile.



UNIVERSAL PLUG

ART. 7203341N

€ TBC
10 / 100 / -

12V - 10A

ART. 7203342N

€ TBC
10 / 100 / -

12V - 15A

Spina universale 12V. Completa di fusibile di sicurezza integrato.



PROLONGER 12V

ART. 0722083N

€ TBC
12 / 48 / -

12V

Cavo di prolunga con spina universale 12V. Fusibile da 10A. Lunghezza cavo: 3 m



SPIRAL PROLONGER 12V

ART. 0722084N

€ TBC
12 / 48 / -

12V

Cavo di prolunga a spirale con spina universale 12V. Fusibile da 5A. Lunghezza cavo: 2 m



CAPTOR 13/7

ART. 7203593C

€ TBC
5 / 10 / -

PACK 1X

Adattatore da presa 13 poli (veicolo) a presa 7 poli (rimorchio).



CAPTOR 7/13

ART. 7203595C

€ TBC
5 / 10 / -

PACK 1X

Adattatore da presa 7 poli (veicolo) a presa 13 poli (rimorchio).



TWIN CONNECT

ART. 7203356N

12V

Connettore doppio 12V con due prese per spine accendisigari. Fusibile da 10A.



TWIN CONTROL

ART. 7203357N

€ TBC
6 / 24 / -

12V

Connettore doppio 12V con controllore batteria. Fusibile da 10A.



PLUG 13 P

ART. 7203545C

€ TBC
8 / 8 / -

PACK 1X

Pres a 13 poli. Contatti nickel.



RECEPTACLE 13 P

ART. 7203591C

€ TBC
12 / 12 / -

PACK 1X

Pres a 13 poli. Con distacco automatico per luce antinebbia.



ONBOARD 15

ART. 0301069N

63,5 x 41,5 x 35,3 cm + Cable 15 m

4,25 kg

75

INFO P. 339

3x 1,5m



€ TBC
2 / 4 / 48



PROLONGER

PROLONGER CEE/CEE RUBBER



Cavo di prolunga CEE/CEE. Guaina in gomma. 230V-16A.

			1,5 mm ²		M.O.		Master	
ART. 0301091C	10 m	€ TBC	5	10	-			
ART. 0301091N	10 m	€ TBC	5	10	-			
ART. 0301092C	25 m	€ TBC	4	4	-			
ART. 0301092N	25 m	€ TBC	4	4	-			
ART. 0301095N	50 m	€ TBC	2	2	-			

			2,5 mm ²		M.O.		Master	
ART. 0301122C	5 m	€ TBC	6	6	-			
ART. 0301122N	5 m	€ TBC	6	6	-			
ART. 0301093C	10 m	€ TBC	6	6	-			
ART. 0301093N	10 m	€ TBC	6	6	-			
ART. 0301096C	15 m	€ TBC	6	6	-			
ART. 0301096N	15 m	€ TBC	6	6	-			
ART. 0301094C	25 m	€ TBC	4	4	-			
ART. 0301094N	25 m	€ TBC	4	4	-			

PROLONGER SCHUKO/SCHUKO



Cavo di prolunga Schuko/Schuko. Guaina in gomma. 230V-16A.

			1,5 mm ²		M.O.		Master	
ART. 0301111C	10 m	€ TBC	6	6	-			
ART. 0301111N	10 m	€ TBC	6	6	-			
ART. 0301112C	25 m	€ TBC	4	4	-			
ART. 0301112N	25 m	€ TBC	4	4	-			

			2,5 mm ²		M.O.		Master	
ART. 0301123C	5 m	€ TBC	6	6	-			
ART. 0301123N	5 m	€ TBC	6	6	-			
ART. 0301108C	10 m	€ TBC	6	6	-			
ART. 0301108N	10 m	€ TBC	6	6	-			
ART. 0301109C	25 m	€ TBC	4	4	-			
ART. 0301109N	25 m	€ TBC	4	4	-			

PROLONGER CEE/SCHUKO RUBBER



Cavo di prolunga CEE/Schuko. Guaina in gomma. 230V-16A.

			1,5 mm ²		M.O.		Master	
ART. 0301126C	5 m	€ TBC	6	6	-			
ART. 0301126N	5 m	€ TBC	6	6	-			
ART. 0301127C	10 m	€ TBC	6	6	-			
ART. 0301127N	10 m	€ TBC	6	6	-			
ART. 0301128C	15 m	€ TBC	6	6	-			
ART. 0301128N	15 m	€ TBC	6	6	-			
ART. 0301115C	25 m	€ TBC	4	4	-			
ART. 0301115N	25 m	€ TBC	4	4	-			

			2,5 mm ²		M.O.		Master	
ART. 0301116C	25 m	€ TBC	4	4	-			
ART. 0301116N	25 m	€ TBC	4	4	-			



DRUMMER RUBBER 3X1,5

ART. 0301068N

€ TBC
2 / 2 / 20

25 m / 3x1,5 mm²



DRUMMER RUBBER 3X2,5

ART. 0301081N

€ TBC
2 / 2 / -

25 m / 3x2,5 mm²

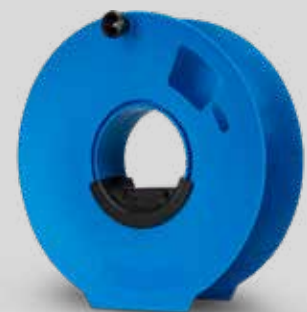

WHEELA

ART. 0301079N

€ TBC
6 / 6 / 72

Ø35,5 x 10,5 cm



Avvolgicavo di alta qualità realizzato in robusto polipropilene. Leggero e funzionale, adatto a tutti i cavi elettrici con una lunghezza fino a 25 metri. Utilizzo semplice ed intuitivo, ideale per caravan, camper e motorhome.

Avvolgicavo CEE (guaina in gomma) dotato di 2 prese Schuko /1 presa CEE con coperchio e protezione da sovraccarico.



ADAPTOR



ADAPTOR CEE/SCHUKO 30 CM

ART. 0301076C € TBC
PACK 1X 10 / 40 / -

ART. 0301076N € TBC
PACK - 10 / 40 / -

30 cm / 3x1,5 mm²



ART. 0301090C € TBC
PACK 1X 10 / 40 / -

ART. 0301090N € TBC
PACK - 10 / 40 / -

30 cm / 3x2,5 mm²



Adattatore CEE/Schuko per esterni. Omologato CE 230V-16A. Cavo in gomma.



ADAPTOR SCHUKO/CEE 90 • 30 CM

ART. 0301082C € TBC
PACK 1X 10 / 40 / -

ART. 0301082N € TBC
PACK - 10 / 40 / -

30 cm / 3x2,5 mm²



Adattatore Schuko/CEE. Omologato CE 230V-16A. Cavo in gomma.



ADAPTOR CEE/CEE 90 • 150 CM

ART. 0301084C € TBC
PACK 1X 5 / 25 / -

ART. 0301084N € TBC
PACK - 5 / 25 / -

150 cm / 3x2,5 mm²



Adattatore CEE/CEE a gomito per esterni. Omologato CE 230V-16A. Cavo in gomma.



ADAPTOR CEE/SCHUKO 150 CM

ART. 0301070C € TBC
PACK 1X 5 / 25 / -

ART. 0301070N € TBC
PACK - 5 / 25 / -

150 cm / 3x1,5 mm²



ART. 0301088C € TBC
PACK 1X 5 / 25 / -

ART. 0301088N € TBC
PACK - 5 / 25 / -

150 cm / 3x2,5 mm²



Adattatore CEE/Schuko per esterni. Omologato CE 230V-16A. Cavo in gomma.



ADAPTOR SCHUKO/CEE 150 CM

ART. 0301071C € TBC
PACK 1X 5 / 25 / -

ART. 0301071N € TBC
PACK - 5 / 25 / -

150 cm / 3x1,5 mm²



ART. 0301086C € TBC
PACK 1X 5 / 25 / -

ART. 0301086N € TBC
PACK - 5 / 25 / -

150 cm / 3x2,5 mm²



Adattatore Schuko/CEE per esterni. Omologato CE 230V-16A. Cavo in gomma.



ADAPTOR SCHUKO/CEE 90 • 150 CM

ART. 0301073C € TBC
PACK 1X 5 / 25 / -

ART. 0301073N € TBC
PACK - 5 / 25 / -

150 cm / 3x1,5 mm²



ART. 0301085C € TBC
PACK 1X 5 / 25 / -

ART. 0301085N € TBC
PACK - 5 / 25 / -

150 cm / 3x2,5 mm²



Adattatore Schuko/CEE a gomito per esterni. Omologato CE 230V-16A. Cavo in gomma.



ADAPTOR CEE/SCHUKO

ART. 7203318C € TBC
PACK 1X 6/6/-

ART. 7203318N € TBC
PACK - 6/6/-

Adattatore CEE/Schuko con presa bipasso. Omologato CE per uso temporaneo.



PLUG CEE 90

ART. 7203452C € TBC
PACK 1X 8/8/-

ART. 7203452N € TBC
PACK - 8/8/-

Presa a gomito CEE con coperchio. Tre poli. Con presa Schuko posteriore.



COUPLER CEE 16A-230V

ART. 7203538C € TBC
PACK 1X 10/10/-

ART. 7203538N € TBC
PACK - 10/10/-

Presa volante CEE 16A-230V.



PLUG CEE 16A-230V

ART. 7203540C € TBC
PACK 1X 6/6/-

ART. 7203540N € TBC
PACK - 6/6/-

Spina volante CEE 16A-230V.

ELECTRO SAFE



ELECTRO SAFE

ART. 7203438N € TBC
6/24/504

Ø 87 x 210 mm

Contenitore di protezione antispruzzo in materiale plastico per raccordi Schuko.

ELECTRO SAFE CEE

ART. 7203437N € TBC
6/24/288

Ø 94 x 375 mm

Contenitore di protezione antispruzzo in materiale plastico per raccordi CEE.



WATER & SANITATION

**GHIRBE
DOCCE
PRODOTTI PER LA PULIZIA**



WEDOR





STANDARD
DIN 96

WEDOR CHH 22

ART. 08 10055N

€ TBC
1/1/24

 26 x 32,5 x 53/87 cm

 3,7 kg

Serbatoio mobile per acque grigie 22l.

- Realizzato in resistente materiale plastico HDPE
- Compatto e leggero
- Maniglia di trasporto pieghevole
- Con indicatore di livello e manicotto di scarico
- Grandi ruote facilitano il trasporto
- Completo di scarico e coperchi a vite

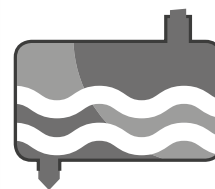

WEDOR CHH 40

ART. 08 10057N

€ TBC
1/1/18

 37,5 x 23 x 80 cm

 40 l

Serbatoio mobile per acqua potabile 40l.

- Realizzato in resistente materiale plastico HDPE
- Compatto e leggero
- Maniglia di trasporto integrata
- Grandi ruote facilitano il trasporto
- Completo di tubo di scarico e coperchi a vite

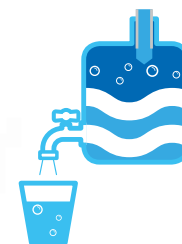



OPTILOO

ART. 0402030N

€ TBC

1 / 1 / 16

39 x 41,5 x H43 cm

2,4 kg

7 l

OPTITOIL

ART. 0402023N

€ TBC

1 / 1 / 16

40 x 48 x H33 cm

2,4 kg

7 l

OPTIPOT

ART. 0402028N

€ TBC

6 / 6 / 20

31 x 31 x H37 cm

1,0 kg

23,5 l

Moderno WC portatile con comoda altezza di seduta.

CARATTERISTICHE:

- Sedile e coperchio possono essere aperti e chiusi separatamente
- Secchio estraibile con coperchio
- Supporto per carta igienica
- Costruzione robusta fatta in resistente PP
- Design moderno

Moderna toilette portatile con seduta, coperchio e secchio chiudibile separatamente.



WC portatile a secchio con tavoletta, coperchio e maniglia per il trasporto. Costruzione robusta e stabile in materiale plastico. Compatto e facile da trasportare rappresenta una soluzione pratica e conveniente in ambito outdoor e camping.

OPTIBAG

ART. 0402037N

€ TBC

10 / 20 / -

PACK 25X



BIO- DEGRADABLE

Sacchetti in plastica biodegradabile e compostabile per WC portatili.



WC-MASK

ART. 0402031N

€ TBC

20 / 160 / -

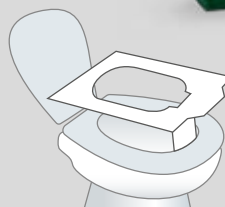

BIO- DEGRADABLE
DISSOLVABLE IN WATER

Coprisedile igienico per WC in carta dissolvibile. Confezione da 20 pezzi.

CUBE 10

ART. 0810021N

€ TBC

6 / 24 / 240

10 l

CUBE 15

ART. 0810022N

€ TBC

6 / 24 / 192

15 l

Ghirba pieghevole in robusta plastica alimentare. Con foro per appendarla e rubinetto regolabile ON/OFF.



WABOX 10

ART. 0810005N

€ TBC

5 / 20 / -

10 l

WABOX 15

ART. 0810006N

€ TBC

5 / 20 / -

15 l

Ghirba pieghevole in morbido materiale plastico alimentare.





FOLDAWAY



BLUE PEARL

ART. 0810010N

€ TBC
12 / 24 / 144

Contenitore d'acqua pieghevole in materiale plastico di alta qualità.

✓ 5,5 l

✂ Ø 19 x 11/25,6 cm



HEAT RESISTANT
40°C



NEW
2025



AQUAFLEX

ART. 0810075N

€ TBC
6 / 12 / -

✓ 10 l

✂ 33 x 20 x 25 cm



Realizzato in materiale PE alimentare di alta qualità e dotato di un robusto involucro protettivo in PP, questa tanica pieghevole è costruita per resistere ai rigori di qualsiasi avventura. La sua innovativa struttura pieghevole consente di riporlo e trasportarlo senza sforzo, rendendolo il compagno perfetto per le escursioni, il campeggio o qualsiasi altra attività all'aperto.

JERRY



JERRY PLUS

Ghirba in robusta plastica alimentare. Con foro per appenderla e rubinetto regolabile ON/OFF.

JERRY PRO

Taniche acqua portatili per Outdoor e camping. Caratterizzate da un grande tappo a vite e da un rubinetto ON/OFF. Realizzate in robusto polietilene alimentare.



M.O.
Master



JERRY PLUS 10	ART. 0810063N	10 l	€ TBC	10	10	80
JERRY PLUS 20	ART. 0810064N	20 l	€ TBC	6	6	48
JERRY PRO 15	ART. 0810073N	15 l	€ TBC	6	6	48
JERRY PRO 20	ART. 0810074N	20 l	€ TBC	6	6	36



NEW
2025

PELICANO

ART. 0810078N

€ TBC
5 / 10 / -

✓ 12 l

✂ 31 x 16,5 x 35 cm



Realizzato in materiale PE alimentare di prima qualità, la tanica per l'acqua Pelicano è costruita per offrire prestazioni affidabili e durature. L'ampia apertura di 10 cm di diametro garantisce una pulizia senza problemi e un rifornimento d'acqua agevole, consentendovi di rimanere idratati e rinfrescati ovunque vi portino le vostre avventure. Il rubinetto staccabile offre una manopola ad alto flusso e liberamente regolabile, che consente di controllare il flusso d'acqua con precisione, rendendo facile riempire le bottiglie d'acqua, gli zaini di idratazione o persino sciacquare le mani sporche.

SHOWERS

COLLECTION



PHTHALATE free

SOLAR PHF

ART. 0810018N

€ TBC
6 / 24 / 480

✓ 20 l

Doccia solare in PVC atossico con flusso acqua regolabile e maniglia per appenderla.



SPLASH

ART. 0810023N

€ TBC
6 / 12 / 72

✓ 15 l

Doccia a pressione. Con pompa a pedale e sacchetto custodia.



FONTAY

ART. 7202413N.C00

€ TBC
10 / 80 / 800

📏 125 g

⚙️ 12V - 3A

Rubinetto ad erogazione automatica. Con interruttore microswitch 12V-3A. Pressione massima: 2,5 bar. Foro di montaggio: Ø 19 mm

FONTAY

ART. 7202413N.C37

€ TBC
10 / 80 / 800

📏 125 g

⚙️ 12V - 3A





AQUAFRESH 2.0

ART. 0810013N

€ TBC
6 / 12 / 216

2 kg

12V DC - 35W

l/min 3,5 l/min.

Doccia da viaggio a 12V per taniche d'acqua. Design moderno abbinato a prestazioni migliorate. Ideale per fare la doccia, per pulire il veicolo e/o la bicicletta o per risciacquare i piatti dopo i pasti. Design robusto e compatto. La fornitura contiene: doccetta con tubo flessibile 2m, pompa ad immersione 12V, ventosa per soffione doccia, cavo di collegamento (5m) con spina accendisigari 12V, borsa custodia.

FLUX RG

ART. 0810014N

€ TBC
6 / 12 / 168

620 g

2200mAh Li-Ion RG

l/min 4 l/min

Doccia Outdoor ricaricabile con interruttore ON/OFF. Leggera e senza fili. Ideale per camping, spiaggia, caravaning ed altre attività Outdoor.

CARATTERISTICHE:

- Funzionamento One-Touch
- Ricarica batterie mediante cavo USB
- Funzionamento con batteria al litio integrata



RIOFRESCO

ART. 0810015N

€ TBC
4 / 16 / -

800 g

6000mAh

l/min 6 l/min

La doccia ricaricabile Riofresco è una soluzione versatile e pratica per rimanere puliti e piacevolmente rinfrescati durante le avventure all'aperto. Consente di mantenere l'igiene personale durante le attività all'aperto. Ideale anche per la pulizia di attrezzature o animali domestici. Facile e veloce da installare. È sufficiente immergere la pompa nell'acqua (ad esempio, da un secchio o da un ruscello) e accenderla.

made in
EU

AQUATIC 10L

ART. 7202415C

€ TBC
5 / 25 / -

100 x Ø 38 mm

140 g

12V DC

l/min 10 l/min

Pompa acqua ad immersione. Pressione: 0,6 bar. Completa di 90 cm di cavo elettrico di collegamento.

made in
EU

AQUATIC 18L

ART. 7202418C

€ TBC
5 / 15 / -

110 x Ø 64 mm

260 g

12V DC

l/min 18 l/min

Pompa acqua ad immersione con dispositivo di sfiato automatico. Pressione: 1,0 bar. Completa di 90 cm di cavo elettrico di collegamento.

made in
EU

AQUATIC 22L

ART. 7202419N

€ TBC
15 / 60 / 600

53 x 77 x 130 mm

290 g

12V DC

l/min 22 l/min

Potente pompa ad immersione con valvola di non ritorno e sfiato automatico. Involucro in ABS. Uso universale per bagno e cucina. Pressione: 1,4 bar. Cavo di collegamento da 100 cm.



WASH BRUSH



105 - 175 CM

FLIZ

ART. 7203153N

€ TBC
12 / 12 / 264

105 - 175 cm

720 g

Idrospazzola con manico telescopico in alluminio, manopole in espanso e spazzola filettata con setole delicate. Larghezza spazzola 25 cm. Con attacco rapido.



115 - 180 CM

MOPPY

ART. 7203156N

€ TBC
8 / 8 / 128

115 - 180 cm

780 g

Spazzola telescopica per lavaggio veicoli con manico in alluminio e raccordo rapido.

METAL



EXTRA STRONG

140 - 240 CM

WOSH

ART. 7203150N

€ TBC
8 / 8 / 120

140 - 240 cm

1,46 kg

Spazzola di lavaggio telescopica a connessione rapida e con interruttore. Setole morbide e manico regolabile in lunghezza 140-240 cm circa. Ideale per caravan e camper.

POPY

ART. 0402042N

€ TBC
6 / 24 / 192

Ø 9 x 32 cm

Spazzolino per WC in materiale plastico.

TOBY

ART. 0402046N

€ TBC
10 / 40 / 400

8 x 25,5 cm

Spazzolino WC di dimensioni molto compatte. Montaggio a parete.

Silicon

TOBY SK

ART. 0402044N

€ TBC
10 / 40 / 400

8 x 25,5 cm

Spazzolino WC di dimensioni molto compatte con setole in silicone.



AQUAFIL

ART. 7203138N

€ TBC
2 / 6 / 96

27,5 x 15,5 x 13,5 cm + tube 10 m

3/8

Avvolgitubo portatile con tubo in PVC alimentare da 3/8" e raccordi rapidi. Struttura in resistente materiale plastico. Completo di lancia. Lunghezza tubo: 10 m.



AQUAFIL PRO

ART. 7203133N

€ TBC
6 / 6 / 84

28 x 15 x H30 cm + tube 11,6 m

3/4

Nuovo avvolgitubo dalle dimensioni compatte ideale per riempire i serbatoi o il lavaggio del veicolo, ma anche utilissimo per irrigare piante e fiori durante il soggiorno in campeggio. Involucro in resistente materiale plastico con maniglione integrato.

La fornitura comprende:

- 11,6 m di tubo flessibile alimentare Ø 7,9 mm (10 m interni + 1,6 m esterni di collegamento)
- lancia ergonomica a portata variabile "3 JET"



ROLL ON 2.0

ART. 7203132N

€ TBC
5 / 5 / 30

Ø 40 x H48 cm + tube 15 m

Avvolgitubo di nuova concezione con tubo piatto flessibile, resistente alla torsione e ad uso alimentare (costruzione a 3 camere), che in fase di utilizzo può essere srotolato solo fino alla lunghezza necessaria. Gli attacchi rapidi e la lancia sono inclusi nella fornitura.



FUNNEL

ART. 0810032N

€ TBC
12 / 72 / 720

Ø 14 x 40 cm

Imbuto in plastica con filtro integrato. Con travasatore flessibile.

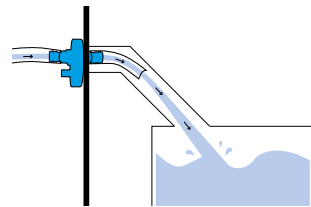

Tappo di riempimento del serbatoio dell'acqua potabile con pratico attacco rapido. Connessione semplice e intuitiva tramite attacco a baionetta con diametro di 67 mm (2 pin) o 77 mm (3 pin). Realizzato in resistente plastica alimentare. Assicura il riempimento igienico e sicuro del serbatoio dell'acqua potabile.



HYDOCK 67

ART. 7203140N

€ TBC
10 / 120 / -

Ø 67mm (2-pin)



HYDOCK 77

ART. 7203145N

€ TBC
10 / 120 / -

Ø 77mm (3-pin)



FELIX 5

ART. 7203136N

€ TBC
10 / 40 / -

tube 5 m

Tubo rifornimento acqua piatto, con guaina resistente a strappi e lacerazioni. Completo di raccordi.

FELIX 9

ART. 7203135N

€ TBC
10 / 40 / 280

tube 9 m



HYNECT S

ART. 7203144C

€ TBC
16 / 16 / -

3/4"



HYNECT

Manicotto per raccordare tubi di gomma alle canneli lisce.



HYNECT T

ART. 7203141C

€ TBC
16 / 16 / -

1/2"



NYLON/POLYESTER

ART. 0205014N

€ TBC

12 / 12 / 360

500 ml

Impermeabilizzante per tessuti in nylon o poliestere. Azione idrorepellente, antideterioramento ed antimuffa.



SYNTHETIC

ART. 0205015N

€ TBC

12 / 12 / 360

500 ml

Impermeabilizzante per tessuti sintetici pesanti (verande-teloni, ecc.). Azione idrorepellente, antideterioramento ed antimuffa.



COTTON

ART. 0205016N

€ TBC

12 / 12 / 360

500 ml

Impermeabilizzante per tessuti naturali. Azione idrorepellente, antideterioramento ed antimuffa.



CLEANER

ART. 0205026N

€ TBC

12 / 12 / 360

500 ml

Detergente per tessuti naturali e sintetici. Rimuove lo sporco senza indebolire tessuto e fibre.



SEALER

ART. 0202099N

€ TBC

24 / 24 / 240

100 ml

Sigillante per cuciture su tessuti naturali e sintetici. Trasparente, elastico e lavabile.



ACTI-GUM

ART. 0205044N

€ TBC

24 / 24 / 600

100 ml

Gel lubrificante silconico per fessure, profili, guarnizioni, cerniere, pali tenda, ecc.



ACTI-MAT REPAIR

ART. 0205027N

€ TBC

12 / 24 / 240

100 ml

Liquido riparatore sigillante per prodotti in PVC oppure neoprene come materassini, canotti, piccoli gommoni ed articoli gonfiabili in genere. Inodore, non contiene solventi.

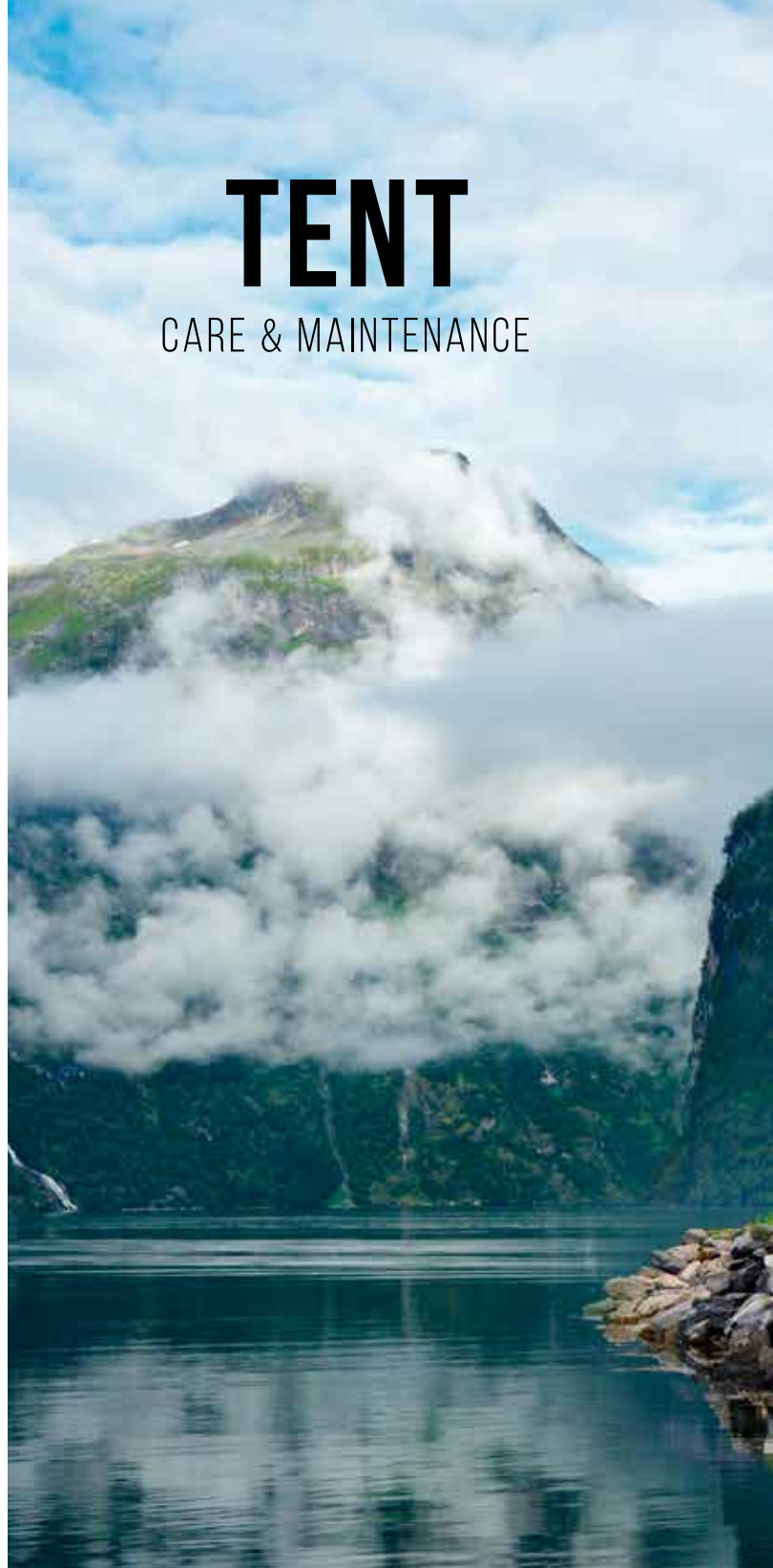

TENT

CARE & MAINTENANCE

CAMPER CARAVAN

CARE & MAINTENANCE



ACTI-FRESH

ART. 0205031N

€ TBC
14 / 14 / 140

1000 ml

ACTI-TANK

ART. 0205033N

€ TBC
14 / 14 / 140

1000 ml

Liquido antifermentativo e deodorante per la rimozione/prevenzione di incrostazioni maleodoranti dai serbatoi di raccolta delle acque grigie.

Liquido disincrostante per la rimozione di incrostazioni inorganiche (calcare) ed organiche (alghie, batteri) da serbatoi e condutture.



ACRYGLASS

ART. 0205012N

€ TBC
12 / 12 / 240

500 ml

ACTI-WASH

ART. 0205030N

€ TBC
12 / 12 / 360

500 ml

Detergente speciale per vetri acrilici. Rimuove insetti, nicotina, grasso, fuliggine, ecc. senza danneggiare il vetro.

Detergente superconcentrato per il lavaggio manuale della carrozzeria di camper, caravan ed autoveicoli.

ACTI-CLEAN

ART. 0205045N

€ TBC
12 / 12 / 240

500 ml



Detergente specifico per la rimozione da superfici in metallo e plastica di forti contaminazioni.



TECHNIQUE

**COPERTURA E PROTEZIONI
ACCESSORI VR**

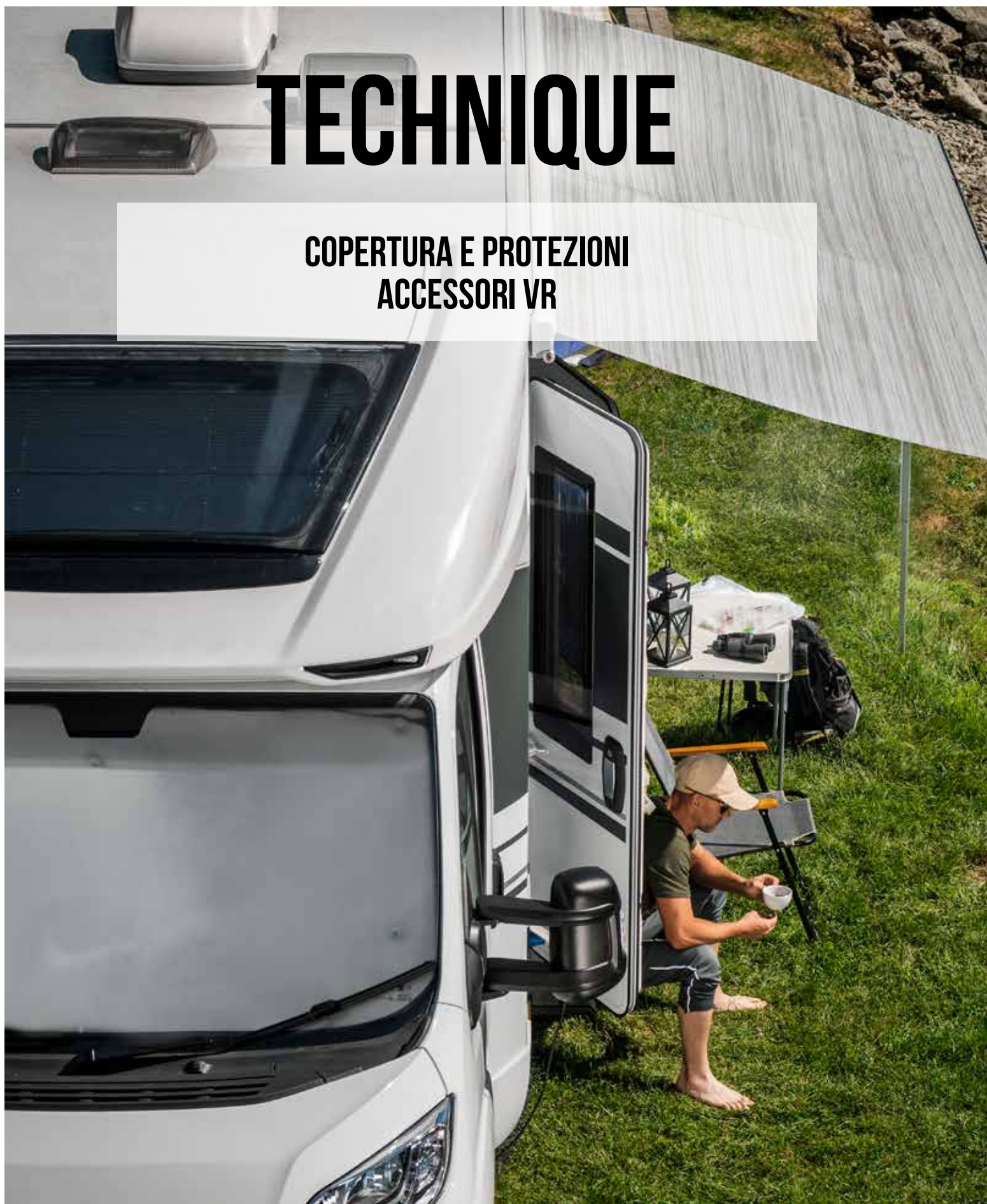

FLYNET MIDI



alu

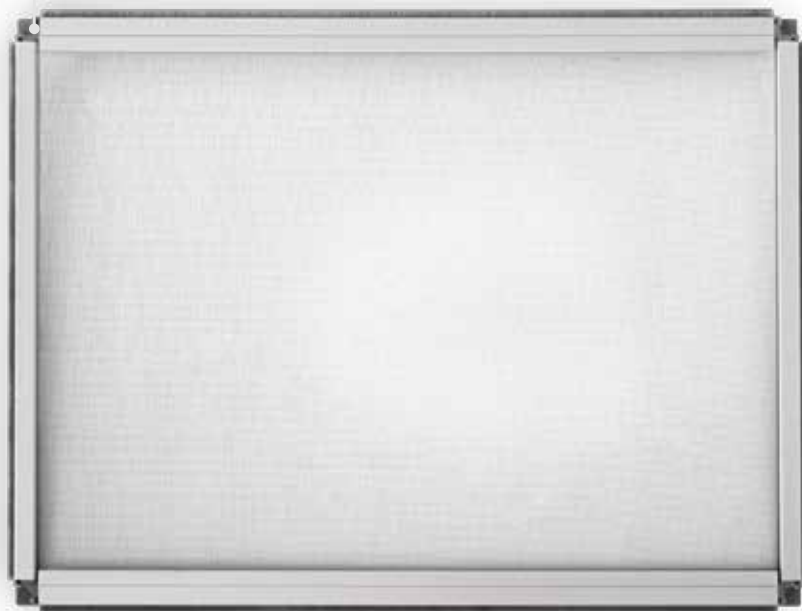

FLYNET MIDI

ART. 7232148N

€ TBC
1 / 1 / 140

62,5 x 46 x H1,4 cm
600g

made in
EU

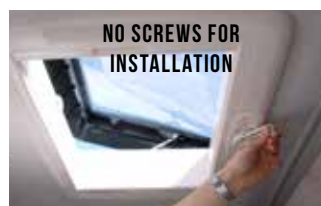

superlight

EASY
INSTALLATION

CARATTERISTICHE:

- Telaio in alluminio di peso ridotto ed elevata stabilità
- Zanzariera in tessuto di fibra di vetro resistente alle intemperie
- Aspetto di alto livello grazie al moderno profilo in alluminio con bordi arrotondati e spazzole laterali
- Montaggio senza forare e/o avvitare
- Pronta per l'uso
- Adatta per il Midi-Heki originale Dometic con funzionamento a manovella
- Prodotta in UE

Zanzariera aggiuntiva con telaio in alluminio per il Dometic Midi Heki con funzionamento a manovella.

Impedite la penetrazione di sporcizia ed insetti fastidiosi con la nuova zanzariera FLYNET di nuova concezione. Con FLYNET la protezione del vostro veicolo inizia già a livello del tetto ed il fastidioso deposito di mosche, zanzare e altri parassiti, ma anche di foglie, aghi di alberi, ecc. sulla zanzariera interna e sulla tendina oscurante viene completamente eliminato.

FLYNET utilizza un telaio in alluminio di alta qualità. Ciò consente un fissaggio rapido, semplice e permanente al Dometic Midi Heki (con manovella) senza la necessità di fastidiose forature e/o avvitiamenti. Il telaio dell'oblò Heki rimane completamente integro ed è visivamente migliorato. Se si desidera rimuovere la FLYNET per la pulizia o durante la pausa invernale, è sufficiente sollevarla ed estrarla.



CAMPER COVER SI

SEMI-INTEGRATED MOTORHOMES

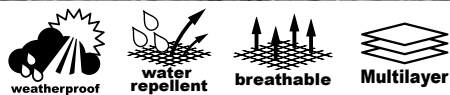

STAND-OFF SET

ART. 7110120N

€ TBC
4 / 4 / -

12 x 11,8 x 7,4 cm

22 g

PACK 4X

Distanziatori per coperture di protezione in materiale schiumato EPP. Utilissimi per proteggere le parti esterne e le finestre del veicolo da sfregamenti ed abrasioni. Set 4 pezzi.



CORNER GUARD SET

ART. 7110121N

€ TBC
4 / 4 / -

27,4 x 17,6 x 6,9 cm

44 g

PACK 4X

Protezioni angolari in resistente materiale schiumato EPP. Utilissime per bloccare le cinghie di tensione ed evitarne il contatto con i bordi inferiori del veicolo. Set 4 pezzi.

CAMPER COVER SI 6M

			M.O.	Master	
ART. 7241507N	600 - 650	€ TBC	1	1	12
ART. 7241508N	650 - 700	€ TBC	1	1	12
ART. 7241509N	700 - 750	€ TBC	1	1	12
ART. 7241510N	750 - 800	€ TBC	1	1	12

Copertura protettiva per camper semi-integrali.

CARATTERISTICHE:

- Tessuto traspirante e idrorepellente
- Tessuto non tessuto a 4 strati
- Sviluppato per l'uso invernale

WINTER PROTECTION



Art.	7241507N	7241508N	7241509N	7241510N
cover size in cm	650x240x250	700x240x250	750x240x250	800x240x250
Size A cm	650	700	750	800
Size B cm	240	240	240	240
Size C cm	250	250	250	250

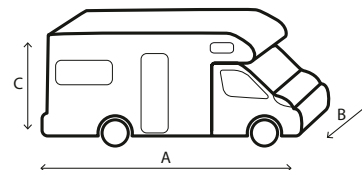

CAMPER COVER

ALCOVE MOTORHOMES

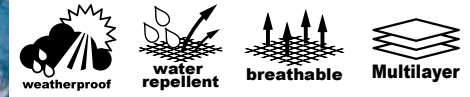

WINTER PROTECTION 

CAMPER COVER 6M

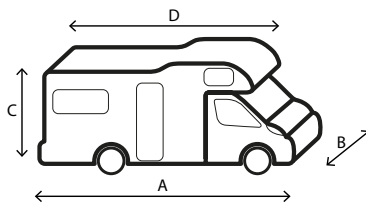

			M.O.	Master	
ART. 7241482N	500 - 550	€ TBC	1	1	10
ART. 7241484N	550 - 600	€ TBC	1	1	10
ART. 7241485N	600 - 650	€ TBC	1	1	10
ART. 7241486N	650 - 700	€ TBC	1	1	10
ART. 7241487N	700 - 750	€ TBC	1	1	10
ART. 7241488N	750 - 800	€ TBC	1	1	10
ART. 7241489N	800 - 850	€ TBC	1	1	10

Copertura protettiva per camper alcova. Versione più larga e più alta. Tessuto TNT traspirante. Resistente ai raggi UV, idrorepellente e lavabile. Viene fornita in una comoda sacca custodia.

Art.	7241482N	7241484N	7241485N	7241486N	7241487N	7241488N	7241489N
cover size in cm	550x240x270	600x240x270	650x240x270	700x240x270	750x240x270	800x240x270	850x240x270
Size A cm	550	600	650	700	750	800	850
Size B cm	240	240	240	240	240	240	240
Size C cm	270	270	270	270	270	270	270
Size D cm	495	545	595	645	695	745	795

INFO

WINTER PROTECTION 

I materiali utilizzati per il tetto: Tessuto non tessuto simile alla carta realizzato con microfili di polietilene ad alta densità (PE-HD). Ideale per coperture all'aperto.

- Ottima resistenza chimica
- Resistente all'abrasione
- Traspirante
- Idrorepellente
- Permeabile al vapore acqueo
- Antivento
- Antistatico
- Non brucia, fonde a 135°C
- Flessibile anche con temperature < 0°C
- Precisione dimensionale
- Resistente agli strappi
- Range di temperatura: -75°C - + 80°C





CARAVAN COVER

WINTER PROTECTION

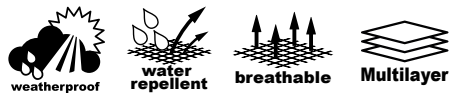

CARAVAN COVER 6M

WINTER PROTECTION



				M.O.	Master	
ART. 7241460N	400 - 450	€ TBC	1	1	12	
ART. 7241461N	450 - 500	€ TBC	1	1	12	
ART. 7241462N	500 - 550	€ TBC	1	1	12	
ART. 7241463N	550 - 600	€ TBC	1	1	12	
ART. 7241464N	600 - 650	€ TBC	1	1	12	
ART. 7241465N	650 - 700	€ TBC	1	1	12	
ART. 7241466N	700 - 750	€ TBC	1	1	12	
ART. 7241467N	750 - 800	€ TBC	1	1	12	

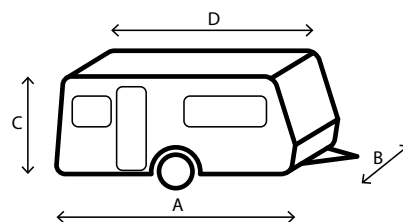

Copertura protettiva per caravan. Tessuto TNT traspirante. Resistente ai raggi UV, idrorepellente e lavabile. Viene fornita in una comoda sacca custodia.

Art.	7241460N	7241461N	7241462N	7241463N	7241464N	7241465N	7241466N	7241467N
cover size in cm	450x240x220	500x240x220	550x250x220	600x250x220	650x250x220	700x250x220	750x250x220	800x250x220
Size A cm	450	500	550	600	650	700	750	800
Size B cm	240	240	250	250	250	250	250	250
Size C cm	220	220	220	220	220	220	220	220
Size D cm	405	455	505	555	605	655	705	755

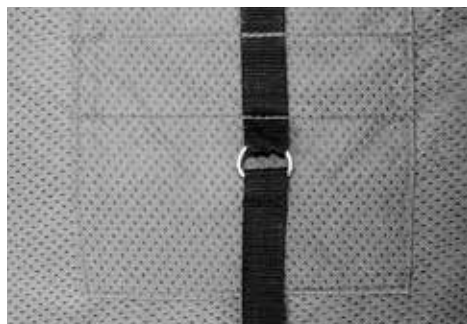

PRO COVER DESIGN

12M DUCATO

SUMMER / WINTER
PROTECTION 

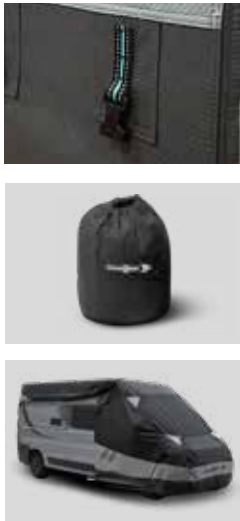

			M.O.	Master	
ART. 7241451N	575 x 210 x H230 cm	€ TBC	1	1	12
ART. 7241452N	635 x 210 x H250 cm	€ TBC	1	1	12
ART. 7241453N	675 x 210 x H250 cm	€ TBC	1	1	12

Copertura di protezione 12M a 4 strati realizzata appositamente per camper Ducato. Realizzata con materiali e finiture di ottima qualità che garantiscono un'efficace protezione del mezzo durante tutto l'anno. Disponibile in 3 misure.

TOP COVER



			M.O.	Master	
ART. 7241470N	400 - 450 x 390 cm	€ TBC	1	1	12
ART. 7241471N	450 - 500 x 390 cm	€ TBC	1	1	12
ART. 7241472N	500 - 550 x 390 cm	€ TBC	1	1	12
ART. 7241473N	550 - 600 x 390 cm	€ TBC	1	1	12
ART. 7241474N	600 - 650 x 390 cm	€ TBC	1	1	12
ART. 7241475N	650 - 700 x 390 cm	€ TBC	1	1	6
ART. 7241476N	700 - 750 x 390 cm	€ TBC	1	1	6
ART. 7241477N	750 - 800 x 390 cm	€ TBC	1	1	6

Funzionale copertura per tetti caravan. Realizzata in TNT a 4 strati traspirante ma idrorepellente. Dotato di pratica sacca custodia.

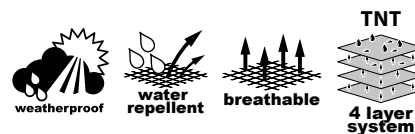



CAMPER COVER DESIGN

SUMMER / WINTER PROTECTION

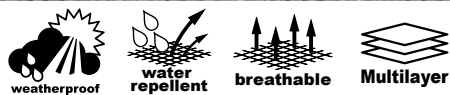

SUMMER / WINTER PROTECTION



UV protection

CAMPER COVER DESIGN 12M

			M.O.	Master	
ART. 7241540N	500 - 550 cm	€ TBC	1	1	12
ART. 7241541N	550 - 600 cm	€ TBC	1	1	12
ART. 7241542N	600 - 650 cm	€ TBC	1	1	12
ART. 7241543N	650 - 700 cm	€ TBC	1	1	12
ART. 7241544N	700 - 750 cm	€ TBC	1	1	12
ART. 7241545N	750 - 800 cm	€ TBC	1	1	12
ART. 7241546N	800 - 850 cm	€ TBC	1	1	12

Le coperture per camper della linea Design 12M fanno tesoro della nostra continua ricerca di soluzioni all'avanguardia e consolidano 5 anni di esperienza nella produzione unendola ad un nuovo design moderno e accattivante che si ispira alla veste grafica attualmente riscontrabile su molti veicoli ricreazionali.

CARATTERISTICHE:

- Tessuto in TNT antigraffio e traspirante a 4 strati resistente ai raggi UV
- Ottima protezione del mezzo da fattori esterni quali pioggia, sole, polvere, inquinamento chimico, escrementi animali, foglie, ecc.
- Ottimo sistema di fissaggio antivento mediante robuste cinghie dotate di fibbia tensionatrice
- Dotate di cerniere laterali che permettono un comodo accesso al mezzo quando coperto
- Dotate di cerniere posteriori che facilitano notevolmente le operazioni di copertura e permettono l'accesso alla parte posteriore del mezzo quando coperto
- Complete di sacca custodia
- Colore: grigio chiaro/grigio scuro

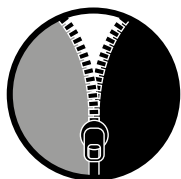

EQUIPPED WITH REAR ZIPS

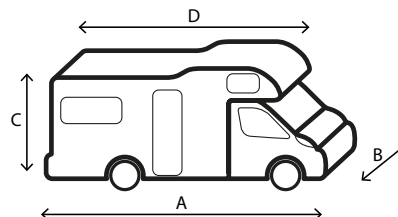

Art.	7241540N	7241541N	7241542N	7241543N	7241544N	7241545N	7241546N
cover size in cm	550x240x270	600x240x270	650x240x270	700x240x270	750x240x270	800x240x270	850x240x270
Size A cm	550	600	650	700	750	800	850
Size B cm	240	240	240	240	240	240	240
Size C cm	270	270	270	270	270	270	270
Size D cm	495	545	595	645	695	745	795

CARAVAN COVER DESIGN

SUMMER / WINTER PROTECTION

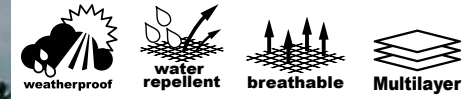

SUMMER / WINTER PROTECTION



Le coperture per caravan della linea Design 12M fanno tesoro della nostra continua ricerca di soluzioni all'avanguardia e consolidano 5 anni di esperienza nella produzione unendola ad un nuovo design moderno e accattivante che si ispira alla veste grafica attualmente riscontrabile su molti veicoli ricreazionali.

CARATTERISTICHE:

- Tessuto in TNT antigraffio e traspirante a 4 strati resistente ai raggi UV
- Ottima protezione del mezzo da fattori esterni quali pioggia, sole, polvere, inquinamento chimico, escrementi animali, foglie, ecc.
- Ottimo sistema di fissaggio antivento mediante robuste cinghie dotate di fibbia tensionatrice
- Dotate di cerniere laterali che permettono un comodo accesso al mezzo quando coperto
- Dotate di cerniere posteriori che facilitano notevolmente le operazioni di copertura e permettono l'accesso alla parte posteriore del mezzo quando coperto
- Complete di sacca custodia
- Colore: grigio chiaro/grigio scuro

CARAVAN COVER DESIGN 12M

				M.O.	Master
ART. 7241550N	400 - 450 cm	€ TBC	1	1	12
ART. 7241551N	450 - 500 cm	€ TBC	1	1	12
ART. 7241552N	500 - 550 cm	€ TBC	1	1	12
ART. 7241553N	550 - 600 cm	€ TBC	1	1	12
ART. 7241554N	600 - 650 cm	€ TBC	1	1	12
ART. 7241555N	650 - 700 cm	€ TBC	1	1	12
ART. 7241556N	700 - 750 cm	€ TBC	1	1	12
ART. 7241557N	750 - 800 cm	€ TBC	1	1	12

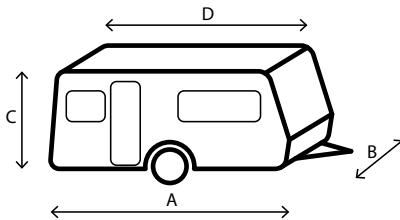

EQUIPPED WITH REAR ZIPS

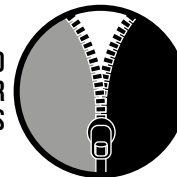

Art.	7241550N	7241551N	7241552N	7241553N	7241554N	7241555N	7241556N	7241557N
cover size in cm	450x240x220	500x240x220	550x250x220	600x250x220	650x250x220	700x250x220	750x250x220	800x250x220
Size A cm	450	500	550	600	650	700	750	800
Size B cm	240	240	250	250	250	250	250	250
Size C cm	220	220	220	220	220	220	220	220
Size D cm	405	455	505	555	605	655	705	755



CLI-MATS XT NG



Nuovo materiale termico appositamente sviluppato per la copertura di veicoli ricreazionali che, grazie alla sua consistenza morbida, si adatta perfettamente ai contorni del parabrezza e dei finestrini laterali della cabina.

CARATTERISTICHE:

- Materiale in poliestere di alta qualità
- Non trattiene l'umidità
- Resistente a temperature fino a -35°C
- Protegge dal freddo e dal caldo
- Il pannello di copertura può essere ripiegato/aperto per far entrare la luce
- Stabile ai raggi UV
- Peso ridotto
- La copertura può essere arrotolata o ripiegata anche in condizioni di freddo intenso
- Installazione semplice

ART.	Modello	Prezzo	M.O.	Master	Icona
ART. 7241181N	Fiat Ducato 07/2006-06/2014	€ TBC	1	4	-
ART. 7241182N	Fiat Ducato 07/2014-->	€ TBC	1	4	-
ART. 7241183N	Mercedes Benz Sprinter 07/2006-06/2014	€ TBC	1	4	-
ART. 7241184N	Mercedes Benz Sprinter 07/2014-06/20218	€ TBC	1	4	-
ART. 7241185N	Mercedes Benz Sprinter 07/2018-->	€ TBC	1	4	-
ART. 7241186N	Ford Transit 07/2014-06/2020	€ TBC	1	4	-
ART. 7241187N	Ford Transit 07/2014-->	€ TBC	1	4	-
ART. 7241188N	Ford Transit Custom 07/2020	€ TBC	1	4	-
ART. 7241189N	Ford Transit Custom 12/2017-->	€ TBC	1	4	-
ART. 7241190N	Ford Transit Custom RS 12/2017-->	€ TBC	1	4	-
ART. 7241191N	VW T5 06/2003-06/2014	€ TBC	1	4	-
ART. 7241192N	VW T6 07/2014-->	€ TBC	1	4	-
ART. 7241193N	Citroen Campster 2017-->	€ TBC	1	4	-

CARA-MATS NG

Nuovo materiale termico appositamente sviluppato per coprire/oscurare le finestre delle caravan che, grazie alla sua consistenza morbida, si adatta perfettamente alle forme delle finestre.

CARATTERISTICHE:

- Materiale in poliestere di alta qualità
- Non trattiene l'umidità
- Resistente a temperature fino a -35°C
- Protegge dal freddo e dal caldo
- Stabile ai raggi UV



ART.	Dimensioni	Prezzo	M.O.	Master	Icona
ART. 7241370N	110 x 55 cm	€ TBC	1	4	-
ART. 7241371N	110 x 75 cm	€ TBC	1	4	-
ART. 7241372N	130 x 75 cm	€ TBC	1	4	-
ART. 7241373N	140 x 75 cm	€ TBC	1	4	-
ART. 7241374N	160 x 75 cm	€ TBC	1	4	-
ART. 7241375N	170 x 75 cm	€ TBC	1	4	-
ART. 7241376N	180 x 80 cm	€ TBC	1	4	-
ART. 7241377N	190 x 80 cm	€ TBC	1	4	-



HEKI COVER PRO

Coperture di protezione concepite appositamente per tutti gli oblò della linea Heki. Costruite con materiale multistrato isolante, resistente alle intemperie ed alla grandine.

ART.	Modello	Prezzo	M.O.	Master	Icona
ART. 7145211N	Heki I	€ TBC	1	1	48
ART. 7145212N	Heki II	€ TBC	1	1	48
ART. 7145213N	Heki III e IV	€ TBC	1	1	48
ART. 7145214N	Mini Heki	€ TBC	1	1	48
ART. 7145215N	Midi Heki	€ TBC	1	1	48
ART. 7145216N	Heki Universal	€ TBC	1	1	48

CLI-MATS SPLIT NG



Nuovo materiale termico appositamente sviluppato per la copertura di veicoli ricreazionali che, grazie alla sua consistenza morbida, si adatta perfettamente ai contorni della carrozzeria del mezzo.

CARATTERISTICHE:

- Materiale in poliestere di alta qualità
- Non trattiene l'umidità
- Resistente a temperature fino a -35°C
- Protegge dal freddo e dal caldo
- La parte superiore può essere montata separatamente (senza la parte inferiore)
- Il pannello superiore può essere ripiegato/aperto per far entrare la luce
- Copertura fino al pavimento
- Stabile ai raggi UV
- Peso ridotto
- Le coperture possono essere arrotolate o ripiegate anche in condizioni di freddo intenso
- Installazione semplice

CLI-MATS SPLIT NG

ART.	Modello	Prezzo	M.O.	Master	Icona
ART. 7241201N	Fiat Ducato 07/2002-06/2006	€ TBC	1	1	-
ART. 7241202N	Fiat Ducato 07/2006-06/2014	€ TBC	1	1	-
ART. 7241203N	Fiat Ducato 07/2014-->	€ TBC	1	1	-
ART. 7241204N	Mercedes Benz Sprinter 07/2014-06/2018	€ TBC	1	1	-
ART. 7241205N	Mercedes Benz Sprinter 07/2018-->	€ TBC	1	1	-
ART. 7241206N	Ford Transit 07/2006-06/2014	€ TBC	1	1	-
ART. 7241207N	Ford Transit 07/2014-06/2020	€ TBC	1	1	-
ART. 7241208N	Ford Transit 07/2020->	€ TBC	1	1	-
ART. 7241209N	Ford Transit Custom 12/2017-->	€ TBC	1	1	-
ART. 7241210N	Ford Transit Custom RS 12/2017-->	€ TBC	1	1	-





CLI-MATS NT NG

Nuovo materiale termico appositamente sviluppato per la copertura/oscuramento delle cabine di guida dei veicoli ricreazionali che, grazie alla sua consistenza morbida, si adatta perfettamente alla forma dei vetri.

CARATTERISTICHE:

- Materiale in poliestere di alta qualità
- Impedisce la formazione di condensa
- Protegge dal calore
- Installazione semplice grazie alle nuove ventose con filo integrato

ART.	Modello	€ TBC	M.O.	Master	Icona
ART. 7241221N	Fiat Ducato 07/2006-06/2014	€ TBC	1	4	-
ART. 7241222N	Fiat Ducato 07/2014-->	€ TBC	1	4	-
ART. 7241223N	Mercedes Benz Sprinter 07/2006-06/2014	€ TBC	1	4	-
ART. 7241224N	Mercedes Benz Sprinter 07/2014-06/2018	€ TBC	1	4	-
ART. 7241225N	Mercedes Benz Sprinter 07/2018-->	€ TBC	1	4	-
ART. 7241226N	Ford Transit 07/2006-06/2014	€ TBC	1	4	-
ART. 7241227N	Ford Transit 7/2014-06/2020	€ TBC	1	4	-
ART. 7241228N	Ford Transit 07/2020	€ TBC	1	4	-
ART. 7241229N	Ford Transit Custom 12/2017-->	€ TBC	1	4	-
ART. 7241230N	Ford Transit Custom RS 12/2017-->	€ TBC	1	4	-
ART. 7241231N	VW T5 06/2003-06/2014	€ TBC	1	4	-
ART. 7241232N	VW T6 07/2014->	€ TBC	1	4	-
ART. 7241233N	Citroen Campster 2017-->	€ TBC	1	4	-



← H150 CM →



CLI-MATS NT ROLL

ART. 7241299N

€ TBC
50 / 50 / -

- Roll 50 m
- PE / PVC

Tessuto isolante a 7 strati per oscuranti Cli-Mats.

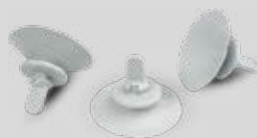

CLI-MATS CAPS

ART. 7241327C

PACK 3X

Kit ventose per oscuranti termici Cli-Mats.



CLI-MATS TR-CAPS

ART. 7241359C

€ TBC
12 / 12 / -

PACK 3X

Ventosa filettata per oscuranti termici. Permettono di rimuovere temporaneamente gli oscuranti senza dover staccare le ventose.



A-COVER

ART. 7130209N

€ TBC
10 / 20 / 500

100% PVC



Copritimone in foglio di PVC, con bordatura di rinforzo.

GASTANK COVER

ART. 7130214N

€ TBC
8 / 8 / 120

PE / PVC



Protezione multistrato in materiale termoriflettente per bombole gas 11 kg.



WHEEL COVER



M.O. Master

ART.	Description	€ TBC	M.O.	Master	
ART. 7130205N	For caravan tyres (13" - 15")	€ TBC	6	12	-
ART. 7130208N	For motorhome tyres (16" - 18")	€ TBC	6	12	-



Protezioni copri ruote per caravan e camper.



APRON 50

ART. 7130215N

€ TBC
1 / 1 / -

Roll 50 m x H50 cm

100% PVC

APRON 70

ART. 7130216N

€ TBC
1 / 1 / -

Roll 50 m x H70 cm

100% PVC

APRON STORAGE

ART. 7130217N

€ TBC
1 / 6 / 66

600 x 40 + 14 cm

Polyester Oxford PVC



Grembiule paravento per verande caravan. Realizzato in resistentissimo tessuto spalmato PVC su entrambi i lati.

ATTENZIONE: LA VENDITA DI QUESTO PRODOTTO NON E' CONSENTITA IN GERMANIA

Pratica protezione antivento dotata di grandi scomparti con cerniera. Unica lunghezza, adattabile alla misura desiderata.



Tappetino per cabina guida.



TAPIS DELUXE

TAPIS DELUXE

ART.	Modello	Prezzo	M.O.	Master	Icona	
ART. 0201200N	Fiat Ducato 1991-06/1994	€ TBC	1	6	120	
ART. 0201201N	Fiat Ducato 07/1994-06/2002	€ TBC	1	6	120	
ART. 0201202N	Fiat Ducato 244 07/2002-06/2006	€ TBC	1	6	120	
ART. 0201215N	Fiat Ducato x250 07/2006-06/2014	€ TBC	1	6	120	
ART. 0201205N	Fiat Ducato x290 07/2014-06/2019	€ TBC	1	6	120	
ART. 0201192N	Fiat Ducato 07/2019-->	€ TBC	1	6	120	
ART. 0201216N	Mercedes Benz Sprinter 07/2000-06/2006	€ TBC	1	6	120	
ART. 0201204N	Mercedes Benz Sprinter 07/2006-06/2014	€ TBC	1	6	120	
ART. 0201195N	Mercedes Benz Sprinter 07/2014-06/2018	€ TBC	1	6	120	
ART. 0201193N	Mercedes Benz Sprinter 07/2018-->	€ TBC	1	6	120	
ART. 0201219N	Ford Transit 2.7 07/2006-06/2014	€ TBC	1	6	120	
ART. 0201206N	Ford Transit 2.8 07/2014 --> / Ford Transit Custom 10/2012 --> / Ford Transit Custom Rain Sensor 12/2017 -->	€ TBC	1	6	120	
ART. 0201208N	VW T5 06/2003-06/2014	€ TBC	1	6	120	
ART. 0201226N	VW T6 07/2014-->	€ TBC	1	6	120	
ART. 0201227N	VW Crafter 07/2012-06/2017	€ TBC	1	6	120	
ART. 0201222N	Renault Master 45 07/2010-06/2014	€ TBC	1	6	120	
ART. 0201194N	Renault Master 55 07/2014-->	€ TBC	1	6	120	
ART. 0201224N	Iveco Daily 5S 07/2014-->	€ TBC	1	6	120	
ART. 0201199N	Citroen Campster 2017-->	€ TBC	1	6	120	



TAPIS DELUXE SECURITY

Tappeto per cabina guida con sistema di bloccaggio.

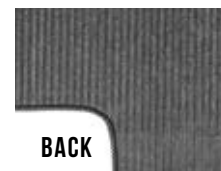
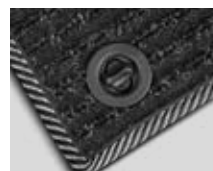

BACK

ART.	Modello	Prezzo	M.O.	Master	Icona	
ART. 0201240N	Ducato 2006-14	€ TBC	1	6	120	
ART. 0201239N.C03	Ducato 07/2014-06/2019	€ TBC	1	6	120	
ART. 0201229N.C03	Ducato 07/2019-->	€ TBC	1	12	120	

TAPIS RUBBERMAT

Bellissimi tappetini per cabina guida a sagoma perfetta realizzati interamente in gomma inodore di prima qualità. Ideali per proteggere il veicolo da sporco ed umidità. Ottima aderenza al pavimento del veicolo che evita fastidiosi scivolamenti sotto ai pedali. Facili da posizionare/rimuovere e da pulire. Disponibili per tutti i modelli di veicoli più diffusi.



ART.	Modello	€ TBC	M.O.	Master	
ART. 0201009N	Ducato/Citroen	€ TBC	1	1	120
ART. 0201010N	Transit Custom Automatic	€ TBC	1	1	120
ART. 0201011N	Transit Custom Manual	€ TBC	1	1	120
ART. 0201013N	VW T6.1 Transporter/Multivan 01/2020-->	€ TBC	1	1	120
ART. 0201014N	Transport VW T5 2004--> / VW T6 2015-12/2019	€ TBC	1	1	120

RUNNER

Corsia per veicoli ricreazionali, con fondo antisdrucciolo.



ART.	Dimensioni	€ TBC	M.O.	Master	
ART. 0201003N.C06	45 x 45 cm	€ TBC	1	6	240
ART. 0201001N.C06	80 x 45 cm	€ TBC	1	6	240
ART. 0201004N.C06	150 x 45 cm	€ TBC	1	6	120
ART. 0201002N.C06	200 x 45 cm	€ TBC	1	6	120
ART. 0201006N.C06	250 x 45 cm	€ TBC	1	6	120
ART. 0201007N.C06	300 x 45 cm	€ TBC	1	4	120
ART. 0201008N.C06	350 x 45 cm	€ TBC	1	3	120

STEPPER MICRO

Tappetino di accesso per camper. Fissaggio tramite dispositivo a strappo compreso nella confezione.



ART.	Modello	€ TBC	M.O.	Master	
ART. 0201166N	Ducato 2006-14	€ TBC	1	10	60
ART. 0201170N	Ducato 09/2019-->	€ TBC	1	10	-
ART. 0201180N	Ducato 2002-06	€ TBC	1	10	-
ART. 0201181N	Ford Transit 2006-->	€ TBC	1	10	-
ART. 0201182N	Mercedes Sprinter 2006-->	€ TBC	1	10	-
ART. 0201187N	VW T5	€ TBC	1	10	-
ART. 0201188N	Ducato 2015-08/2019	€ TBC	1	10	-
ART. 0201191N	VW T6	€ TBC	1	10	120



HELLO CAMPER

ART. 0201034N.CA

€ TBC
5 / 15 / 540

25 x 50 cm
 100% PP



HELLO CARAVAN

ART. 0201034N.CV

€ TBC
5 / 15 / 540

25 x 50 cm
 100% PP

Pratico zerbino con simpatici motivi legati al camper e alla caravan. Protegge gli interni del mezzo da terra, polvere e sporco. Dotato di rivestimento inferiore antisdrucciolo.



BIKE COVER

COLLECTION

BIKE COVER SPECIAL 2/3



BIKE COVER 2/3 - BIKE COVER 4



E-BIKE COVER 2



BIKE COVER CVN 2



ART.	DESCRIPTION	€ TBC	M.O.	Master	Icon	
ART. 7130219N	BIKE COVER 2/3	€ TBC	4	4	80	
ART. 7130210N	BIKE COVER 4	€ TBC	4	4	72	
ART. 7130200N	BIKE COVER SPECIAL 2/3	€ TBC	4	4	84	
ART. 7130220N	E-BIKE COVER 2	€ TBC	4	4	72	
ART. 7130212N	BIKE COVER CVN 2	€ TBC	4	4	72	

! Warning sign not included



Copricicchetto in resistente tessuto di poliestere con spalmatura idrorepellente. Dotato di speciale tasca per la sistemazione del cartello carichi sporgenti.



Reflector

BIKE COVER TOW BAR

COLLECTION



Reflector



Warning sign not included



ART.	DESCRIPTION	€ TBC	M.O.	Master
ART. 7130201N	BIKE COVER TB 2	€ TBC	4	4
ART. 7130203N	BIKE COVER TB 4	€ TBC	4	4

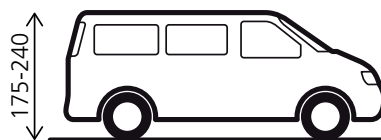

Copribici di alta qualità per portabiciclette montati su gancio di traino. Realizzato in robusto tessuto di poliestere spalmato e impermeabile. La sicurezza è ulteriormente garantita da diverse cinghie di tensione che impediscono l'eccessivo sventolio del telo in caso di forte vento. Con tasca trasparente per cartello carichi sporgenti. Inclusa borsa custodia. Disponibile in 2 versioni, per 2 e 4 biciclette.



ZEBRA PL

ART. 7136010N

€ TBC
10 / 10 / 300

50 x 50 cm

Cartello carichi sporgenti in materiale plastico con 4 retroriflettori. Non omologato in Italia!



ZEBRA ALU

ART. 7136012N

€ TBC
10 / 10 / -

50 x 50 cm

Cartello per carichi sporgenti in alluminio. Obbligatorio in Italia!

BIKE HOOD NG

ART. 7130211N

€ TBC
4 / 4 / 88

Telo protettivo per biciclette adatto anche per piccoli motorini.

220 x 65 x H140 cm
Polyester PU





BAG COLLECTION

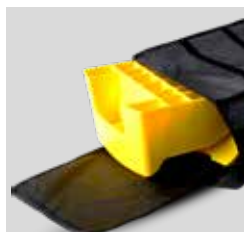

LEVELER BAG

ART. 7241005N

- 57 x 20 x 15 cm
- 100% Oxford Polyester



PRO-BAG CABLE S

ART. 7241009N

- Ø 36 x 10 cm
- 100% Oxford Polyester



PRO-BAG POLES

ART. 7241015N

- 120 x 30 x 25cm
- 100% Oxford Polyester



PRO-BAG MIRROR

ART. 7241016N

- 40 x 20 x 12 cm
- 100% Oxford Polyester



Borsa custodia e di protezione per specchi retrovisori supplementari.



Borsa custodia e di protezione per paleria tende.

€ TBC
10 / 10 / -

€ TBC
10 / 10 / -

€ TBC
10 / 10 / 140

€ TBC
10 / 10 / 260

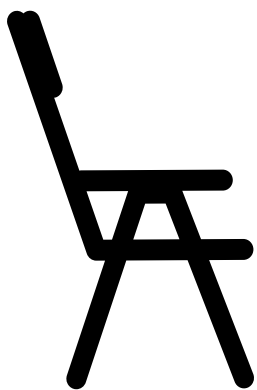

PRO-BAG CHAIR

ART. 7241012N

€ TBC
10 / 10 / 260

 120 x 65 x 24 cm

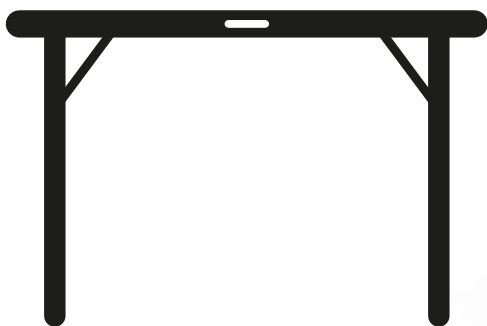

 100% Oxford Polyester

Borsa custodia e di protezione per sedie pieghevoli.



PRO-BAG TABLE

Borsa di protezione e trasporto per tavoli camping ed outdoor realizzata in resistente poliestere.

				€ TBC	M.O.	Master	
PRO-BAG TABLE XS	ART. 7241006N	85 x 65 x 6 cm	100% Oxford Polyester	€ TBC	10	10	-
PRO-BAG TABLE S	ART. 7241010N	100 x 64 x 4 cm	100% Oxford Polyester	€ TBC	10	10	-
PRO-BAG TABLE M	ART. 7241007N	105 x 75 x 6 cm	100% Oxford Polyester	€ TBC	10	10	-
PRO-BAG TABLE L	ART. 7241011N	120 x 72 x 6 cm	100% Oxford Polyester	€ TBC	10	10	-
PRO-BAG TABLE XL	ART. 7241008N	125 x 80 x 7 cm	100% Oxford Polyester	€ TBC	10	10	-



KING STEP

ART. 7225135N

€ TBC
10 / 10 / 60

43 x 30 x H26/31 cm

2,25 kg

150 kg

COLORS



Gradino di entrata con stabile struttura in acciaio e superficie in gomma antiscivolo.



KING DOUBLE STEP

ART. 7225136N

€ TBC
6 / 6 / 18

43 x 63 x H18/38/43 cm

4,1 kg

150 kg

COLORS



Gradino di entrata doppio con stabile struttura in acciaio e superficie in gomma antiscivolo.



KING DOUBLE STEP XL

ART. 7225137N

€ TBC
4 / 4 / 16

55 x 62,5 x H18/38 cm

4,5 kg

150 kg



Elegante gradino doppio con ampia superficie antiscivolo. Sovrapponibile.



KINTA

ART. 7225153N

€ TBC
4 / 4 / 144

63 x 27,5 x H22 cm

50 x 26 x H4,5 cm

2,5 kg

150 kg



Gradino singolo facilmente trasportabile dotato di gambe pieghevoli. La superficie del gradino è realizzata in plastica antiscivolo per offrire la massima sicurezza possibile in entrata e in uscita dal veicolo. Dimensioni molto compatte quando ripiegato.



RUCKSTEP

ART. 7225147N

€ TBC
4 / 4 / 24

61 x 60 x H20/40 cm

81 x 61 x 6,5 cm

6,4 kg

150 kg



Gradino doppio compatto e chiudibile con telaio in metallo e coprigradino anti-slip.



PRIMA

ART. 7225134N

€ TBC
4 / 4 / 24

55 x 61 x H18/37,5/43 cm

67 x 7 x 51 cm

5,5 kg

150 kg



Gradino doppio smontabile realizzato in solido metallo zincato.



COLORS



STEPPER MOVE

ART. 0201162N

€ TBC
10 / 30 / 420

Tappeto coprigradino antiscivolo. Fissaggio mediante l'aggancio di 2 molle nei fori occhiali. Adatto per gradini con larghezza 40 cm e profondità regolabile da 20 a 25 cm.

BLACK FLUO

COLLECTION

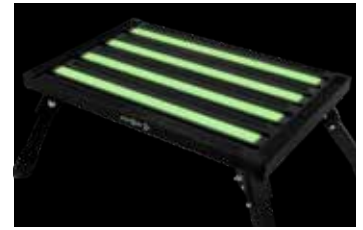

RUCKSTEP BLACK FLUO

ART. 7225149N.C03

€ TBC
4 / 4 / 32

	51,5 x 53 x H19,5/38,5 cm
	51,5 x 9 x H75,5 cm
	4 kg
	150 kg

Gradino doppio pieghevole per camper con verniciatura a polvere nera e strisce di sicurezza fluorescenti. Questo gradino è stato progettato per essere altamente robusto e allo stesso tempo estremamente pratico per tutti i vostri viaggi. Grazie al suo design pieghevole e salvaspazio e alle strisce di sicurezza fluorescenti, non dovrete più preoccuparvi di camminare al buio o di inciampare in un gradino. Pronto all'uso in pochi secondi.

VANTAGGI:

- Robusto e durevole
- Pratico e poco ingombrante
- Sicuro al buio
- Facile da montare e smontare

GO STEP BLACK FLUO

ART. 7225127N.C03

€ TBC
6 / 6 / 60

	48 x 30 x H23 cm
	48 x 30 x H7 cm
	2,65 kg
	150 kg

Il gradino pieghevole per camper GoStep Black Fluo è la soluzione perfetta per tutti i camperisti che desiderano un accesso sicuro e confortevole al proprio veicolo. Il gradino è realizzato in alluminio di alta qualità e presenta un elegante design nero con strisce di sicurezza fluorescenti. Il gradino può essere montato e ripiegato in pochi secondi, in modo da poter essere riposto con un minimo ingombro. Al buio, le strisce di sicurezza fluorescenti garantiscono una buona visibilità.

VANTAGGI:

- Robusto e durevole
- Pratico e poco ingombrante
- Sicuro al buio
- Facile da montare e smontare



RUCKSTEP ALU

ART. 7225149N

€ TBC
4 / 4 / 32

	51,5 x 53 x H19,5/38,5 cm
	51,5 x 9 x H75,5 cm
	4 kg
	150 kg

Gradino doppio per caravan e camper. Struttura pieghevole in alluminio, leggera e robusta. Con superficie antiscivolo. Facile da trasportare e riporre.



GO STEP NG

ART. 7225127N

€ TBC
1 / 6 / 72

	48 x 30 x H23 cm
	48 x 30 x H7 cm
	2,65 kg
	150 kg

Gradino molto stabile con gambe pieghevoli. Robusta costruzione in alluminio verniciato a polveri.



BOXSTEP NG



VIDEO

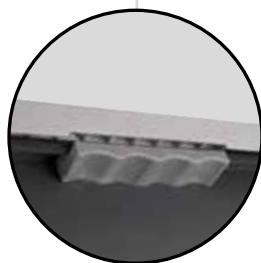

BOXSTEP NG

ART. 7225160N

€ TBC

1 / 1 / 20

58 x 38 x H 24,5 cm

3,92 kg

150 kg

Gradino per veicoli ricreazionali di nuova concezione con spazio interno impermeabile per accessori utili, come attrezzi, liquidi sanitari, prolunghe, ecc. Il coperchio chiudibile mediante gancio a leva è dotato di un profilo antiscivolo ed è dotato anche di una luce solare di sicurezza integrata. Costruzione in plastica di alta qualità, molto stabile, con piedini rotanti per la regolazione del livellamento.



PLYER

ART. 7225138N.C06

€ TBC

6 / 12 / 144

40 x 28 x H23,1 cm

40 x 38,2 x 5,5 cm

1,3 kg

120 kg

Pratico gradino pieghevole per Outdoor e uso casalingo in materiale plastico. Superficie antiscivolo e piedini in gomma.



RIALTO

ART. 7225140N

€ TBC

6 / 6 / 108

45 x 30 x H23 cm

45 x 38,5 x 4,5 cm

2,3 kg

150 kg

Gradino pieghevole compatto per caravan, campeggio e casa. Costruzione in plastica robusta e resistente. Con rivestimento antiscivolo. Facile da piegare e riporre.



WINK

ART. 7225148N

€ TBC

6 / 6 / 60

44,5 x 26,5 x H25,2 cm

55 x 27,5 x 8,3 cm

1,45 kg

120 kg

Gradino pieghevole in plastica con ampia superficie calpestabile e pratiche maniglie per il trasporto. Pronto all'uso in pochi secondi. Costruzione robusta e affidabile. Molto compatto e facile da riporre quando ripiegato.



PODIUM L

ART. 7225146N

€ TBC
12 / 12 / 96

50 x 34 x H23 cm

1,3 kg

150 kg

GAMUT

ART. 7225129N

€ TBC
10 / 10 / 120

49,5 x 34,5 x 23,5 cm

1 kg

120 kg

HOPPER ANTISLIP

ART. 7225142N.C06

€ TBC
10 / 10 / 100

40,5 x 25 x H24,5 cm

1,45 kg

150 kg

Gradino in polietilene ad alta densità per veicoli ricreazionali. Esecuzione solida e stabile. Superficie calpestabile antisdrucchiolo. Impilabile.

Classico gradino per caravan. Completamente realizzato in resistente materiale plastico.

Gradino in plastica per veicoli ricreazionali, con tappetino antiscivolo.



Box in alluminio extra robusti e di alta qualità con uno spessore delle pareti di 1,0 mm. Ideali per lo stivaggio ed il trasporto in sicurezza di attrezzatura importante e di valore grazie alla loro costruzione a tenuta stagna.

CARATTERISTICHE:

- Realizzati in lamiera di alluminio di alta qualità
- Spessore delle pareti di 1,0 mm
- Impermeabile, resistente alle intemperie e alle temperature
- Con bordo di rinforzo su tutto il perimetro
- Robusto coperchio di chiusura
- Con 2 maniglie laterali a molla auto ripiegabili
- 2 chiusure a leva solide e facili da usare
- Guarnizione in gomma su tutto il perimetro del coperchio

OUTBOX



OUTBOX ALU 47

ART. 7440011N

€ TBC
1 / 1 / 16

58,2 x 38,5 x 26,2 cm

4,4 kg

47 l



OUTBOX ALU 73

ART. 7440012N

€ TBC
1 / 1 / 12

58,2 x 38,5 x 39,7 cm

5,2 kg

73 l



OUTBOX ALU 92

ART. 7440013N

€ TBC
1 / 1 / 9

78,2 x 38,5 x 36,7 cm

6,1 kg

92 l



NETRAY HD SMALL

ART. 0420015N

€ TBC
6 / 6 / 144

32,5 x 18 x 8 cm

NETRAY HD MEDIUM

ART. 0420016N

€ TBC
6 / 6 / 144

39 x 20 x 8 cm

NETRAY HD LARGE

ART. 0420018N

€ TBC
6 / 6 / 144

44 x 22,5 x 8 cm



Retina portaoggetti elegante e funzionale composta da un robusto telaio in alluminio verniciato e da una rete elastica. Installazione semplice mediante viti. Disponibile in 3 misure.

FORT KNOX

ART. 7511005N

€ TBC
4 / 16 / 240

20,5 x 15,5 x 8 cm

1,5 kg



Piccolo porta-valori per camper e caravan.

NETRAY

ART. 0420012N

€ TBC
10 / 100 / 800

31,5 x 21 cm

160 g



Rete porta oggetti con bordi in metallo e relativa copertura in materiale plastico. Fissaggio tramite viti.

LADDY

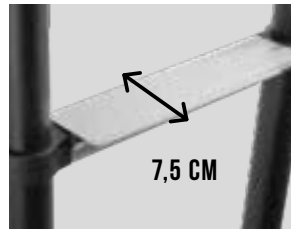

EN 131
AIR SECURITY SYSTEM



2X INCLUDED

EN 131
AIR SECURITY SYSTEM



LADDY AIR

ART. 7225118N

€ TBC
1 / 1 / 25

293 x 47 x 8,4 cm

75 x 47 x 8,4 cm

7,5 kg

150 kg



Scala telescopica in alluminio con nuova tecnologia di chiusura morbida servoassistita che elimina il rischio di lesioni alle dita. Facile da trasportare e regolabile in altezza. Dotata di piedini in gomma antiscivolo per una maggiore sicurezza. Molto compatta quando chiusa.

LADDY ALCOVE AIR

ART. 7225123N

€ TBC
1 / 1 / -

210 x 36 x 6 cm

67 x 36 x 6 cm

4,5 kg

150 kg



Laddy Alcove Air rappresenta una soluzione rivoluzionaria progettata per offrire comfort e versatilità eccezionali. Realizzata con un'ingegneria meticolosa, questa scala in alluminio è dotata di speciali gradini ad inclinazione adattata che favoriscono l'appoggio dei piedi, assicurando un'esperienza di salita sicura e indolore, anche a piedi nudi che consente di accedere senza problemi alle tende sul tetto o ai letti a castello, oltre a facilitare le operazioni di manutenzione e riparazione del veicolo.



TRANSAT ALU

ART. 7512015N

€ TBC
1 / 1 / 33

H122 cm

1,25 kg



Treppiede pieghevole ultraleggero per antenna satellitare in alluminio anodizzato, Ø 40 mm.



RUBBY



		M.O.	Master		
ART. 7440008C	65 mm	€ TBC	12	12	-
ART. 7440008N	65 mm	€ TBC	12	12	-
ART. 7440009C	125 mm	€ TBC	12	12	-
ART. 7440009N	125 mm	€ TBC	12	12	-

Fermabauletti in gomma nera inalterabile, completi di supporto ed accessori in metallo.

Ø 30 MM

Ø 36 MM

Ø 120 MM

SKEYLA

ART. 0712092N

€ TBC
10 / 20 / 80

H42,5 cm

570 g

50 - 100 kg

Bilancia pesatimone.



GRIPPER

ART. 7110117N

€ TBC
10 / 10 / 300

74 x 22,5 cm

750 g

PACK 2X

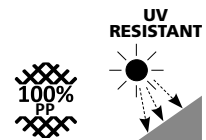

Griglia di partenza con scheletro diagonale. Materiale: PP resistente ai raggi UV.



CARAPAD HD

ART. 7110106N

€ TBC
6 / 12 / -

18 x 14,5 cm

2t / Jack pads

PACK 4X



Basi antisprofondamento per caravan con perno di fissaggio in metallo.



CARAPAD

ART. 7110102N

€ TBC
6 / 12 / 216

18 x 14,5 cm

PACK 4X



Piastre di sostegno per roulotte in materiale plastico resistente.

BASEPAD

ART. 7110116C.C19

€ TBC
12 / 12 / -

Ø 16 cm

PACK 4X



Basi antisprofondamento in resistente materiale plastico.



EQUALIZER XL BLACK

ART. 7110105N.C03

€ TBC
4 / 4 / 48

56,2 x 20,2 x H15 cm

3,7 kg

5t / axle

PACK 2X



Cuneo di livellamento di alta qualità a 3 livelli. Fornito con pratica sacca custodia e da trasporto.

TRIANGLE

ART. 0115009C

PACK 1X

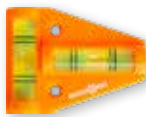
€ TBC
20 / 400 / -

ART. 0115009N

PACK -

€ TBC
20 / 400 / -

58 x 45 mm

Livella a bolla triangolare con bolle perpendicolari e fori di fissaggio.

ALU JACK 2.0

ART. 7140001N

€ TBC
4 / 4 / 96

16 x 16 x H29/42 cm

2x 3,2 kg

1,5t / Jack

Set di martinetti in alluminio con piastra di supporto a L angolata in acciaio zincato e copertura di protezione antiscivolo in plastica morbida. Costruzione molto stabile e impilabile. In set di 2.

**EXTRA
STRONG**

OPTIONAL

ALU JACK PROTECTOR

ART. 7140003N

€ TBC
12 / 12 / -

PACK 2X

Copertura antiscivolo in plastica morbida per martinetti in alluminio con piastra di supporto angolata. Protegge la superficie di appoggio da graffi. Montaggio semplice.



NIVEAU

ART. 0115011C

PACK 1X

€ TBC
12 / 72 / -

ART. 0115011N

PACK -

€ TBC
20 / 100 / -

100 x 35 x 12 mm

Livella a bolla rettangolare con bolle perpendicolari.

POWER JACK

ART. 7140010N

€ TBC
6 / 6 / 108

2x 2,15 kg

1t / Jack

PACK 2X

Set martinetti realizzati in materiale di qualità resistente al freddo ed ai raggi UV.

**EXTRA
STRONG**

LEVEL

ART. 0115005N

€ TBC
5 / 20 / -

230 x 40 x 16 mm

Livella con doppia bolla. Struttura in plastica. Magnetico.



DELTA ANG

ART. 7306330N



€ TBC
6 / 6 / 288

18,5 x 12,5 cm

420 g

PACK 1X

Specchio retrovisore supplementare da fissare agli specchietti laterali già di serie del mezzo. Utilizzabile sia a destra che a sinistra.



GAMMA ANG



PACK

M.O.

Master



ART. 7306335N.DS	22,5 x 16 cm	560 g	1X	€ TBC	6	6	90
ART. 7306335N.PS	22,5 x 16 cm	560 g	1X	€ TBC	6	6	90

Specchio retrovisore supplementare da fissare agli specchietti laterali del mezzo.



RIDER PRO

ART. 7306345N

€ TBC
4 / 4 / 56

22 x 16 cm

2x 620 g

PACK 2X

Specchietto retrovisore universalmente montabile su quasi tutte le autovetture. Anche indicato per specchi originali di grandi dimensioni. Coppa aerodinamica di grandi dimensioni con speciale specchietto supplementare regolabile che rende visibile l'angolo morto. Fissaggio mediante 2 morsetti di bloccaggio a vite ed una cinghia supplementare di sicurezza regolabile in gomma. Fornito in coppia. Conforme alla normativa E11.

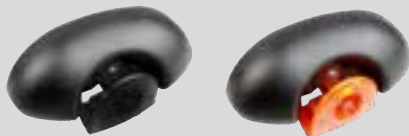

OPTILUS

ART. 7307103N



COLORS



€ TBC
10 / 90 / 1170

14,5 x 6 x 4,5 cm

160 g

PACK 1X

Specchio angolo morto per camper e automobili.



RETRAL

ART. 7307104N

€ TBC
10 / 70 / 420

14,5 x 6 x 4,5 cm

146 g

Speciale specchio retrovisore realizzato per tenere sotto controllo l'abitacolo di camper e vetture.



OROS ANG

ART. 7306328N

 14 x 20 cm

 550 g

PACK 1X

Specchio universale Clip-on che si adatta quasi tutti gli specchi originali con vetro regolabile.





ECLIPSE

ART. 7306375N

€ TBC
6 / 6 / 162



 19 x 12 cm

 630 g

PACK 1X

Specchio retrovisore supplementare universale applicabile su specchi originali mediante morsetti a vite. Con asta di estensione laterale in metallo.

€ TBC
6 / 24 / 240

MIRROR

COLLECTION





DISPLAY BOX

CITRONELLA CANDLE S

ART. 0205055N
12 / 48 / 2304



CITRONELLA CANDLE M

ART. 0205056N
12 / 48 / 1200



LUMINA

ART. 0720061N
8 / 32 / -



SPECTRACOOL 18

ART. 0824038N.C9N
6 / 6 / 90



SPECTRACOOL 25

ART. 0824039N.C9N
6 / 6 / 60



ALFRESCO

ART. 0428054N
6 / 6 / -



FRIOBAG COMPACT

ART. 0824041N
10 / 10 / -



LEGEND OUTDOOR 500

ART. 0820050N
12 / 24 / 456



LEGEND OUTDOOR 1000

ART. 0820051N
12 / 24 / 192



SHOT

ART. 0820055N
12 / 24 / 240



HYDROLIN STEEL 1000

ART. 0820026N
6 / 24 / 168



COOLPAD 400

ART. 0826019N
12 / 24 / -



COOLPAD 200

ART. 0826018N
12 / 24 / -



DRINKMASTER S

ART. 0404029N.C9N
20 / 80 / 1280



DISPLAY CAMPER WINTER 54PCS

ART. 0830142N.C6N
1/1/-

art. 0830051N.C48
art. 0830051N.C1M
art. 0830051N.C06
art. 0830051N.C1C
art. 0830051N.C22
art. 0830051N.C9C

6x9 



DISPLAY CAMPER AQUARIUS 54PCS

ART. 0830142N.C1A
1/1/-

art. 0830051N.C08
art. 0830051N.C06
art. 0830051N.C48
art. 0830051N.C30
art. 0830051N.C1M
art. 0830051N.C22

6x9 



DISPLAY CAMPER SUMMER 54PCS

ART. 0830142N.C4H
1/1/-

art. 0830051N.C34
art. 0830051N.C19
art. 0830051N.C08
art. 0830051N.C06
art. 0830051N.C22
art. 0830051N.C48

6x9 



BBGRILL DINNER PLATE

ART. 0830045N.C5R
12 / 24 / 576



BBGRILL BOWL

ART. 0830047N.C5R
12 / 24 / 480



BBGRILL SALAD BOWL

ART. 0830046N.C5R
6 / 12 / 192



MINI SPOON SET

ART. 0830129N.C9N
24 / 48 / 480



SPOON SET

ART. 0830128N.C9N
24 / 96 / -



SPICE BOX

ART. 0830010N.C9N
24 / 96 / 1728



OLIAC

ART. 0830000N.C4N
12 / 12 / -



HUNGRY

ART. 0830110N.C30
12 / 12 / 360



HUNGRY XL

ART. 0830111N.C30
12 / 12 / 360













DISPLAY BOX DOLOMIT WHITE

ART. 0830141N.C00

1/1/-











- 24x  art. 0830025N.C00
- 24x  art. 0830026N.C00
- 24x  art. 0830027N.C00
- 24x  art. 0830043N.C00
- 16x  art. 0830051N.C00
- 8x  art. 0830030N.C00
- 24x  art. 0830214S.C00
- 4x  art. 0832016N.C06

DISPLAY BOX DOLOMIT BLUE

ART. 0830141N.C28

1/1/-











- 24x  art. 0830025N.C28
- 24x  art. 0830026N.C28
- 24x  art. 0830027N.C28
- 24x  art. 0830043N.C28
- 16x  art. 0830051N.C28
- 8x  art. 0830030N.C28
- 24x  art. 0830214S.C28
- 4x  art. 0832016N.C06

DISPLAY BOX DOLOMIT GREEN

ART. 0830141N.C43

1/1/-











- 24x  art. 0830025N.C43
- 24x  art. 0830026N.C43
- 24x  art. 0830027N.C43
- 24x  art. 0830043N.C43
- 16x  art. 0830051N.C43
- 8x  art. 0830030N.C43
- 24x  art. 0830214S.C43
- 4x  art. 0832016N.C06

DISPLAY BOX DOLOMIT GREY

ART. 0830141N.C20

1/1/-



- 24x  art. 0830025N.C20
- 24x  art. 0830026N.C20
- 24x  art. 0830027N.C20
- 24x  art. 0830043N.C20
- 16x  art. 0830051N.C20
- 8x  art. 0830030N.C20
- 24x  art. 0830214S.C20
- 4x  art. 0832016N.C06

DISPLAY BOX DOLOMIT ROSÈ

ART. 0830141N.C15
1/1/-



24x		art. 0830025N.C28
24x		art. 0830026N.C28
24x		art. 0830027N.C28
24x		art. 0830043N.C28
16x		art. 0830051N.C28
8x		art. 0830030N.C28
24x		art. 0830214S.C28
4x		art. 0832016N.C06



DISPLAY BOX DOLOMIT

ART. 0830141N.C2P
1/1/-



DISPLAY BOX DOLOMIT YELLOW

ART. 0830141N.C88
1/1/-



24x		art. 0830025N.C28
24x		art. 0830026N.C28
24x		art. 0830027N.C28
24x		art. 0830043N.C28
16x		art. 0830051N.C28
8x		art. 0830030N.C28
24x		art. 0830214S.C28
4x		art. 0832016N.C06



6x4		art. 0830025N.C00 art. 0830025N.C43 art. 0830025N.C28 art. 0830025N.C20
-----	--	--

6x4		art. 0830026N.C00 art. 0830026N.C43 art. 0830026N.C28 art. 0830026N.C20
-----	--	--

6x4		art. 0830027N.C00 art. 0830027N.C43 art. 0830027N.C28 art. 0830027N.C20
-----	--	--

6x4		art. 0830043N.C00 art. 0830043N.C43 art. 0830043N.C28 art. 0830043N.C20
-----	--	--

4x4		art. 0830051N.C00 art. 0830051N.C43 art. 0830051N.C28 art. 0830051N.C20
-----	--	--

2x4		art. 0830030N.C00 art. 0830030N.C43 art. 0830030N.C28 art. 0830030N.C20
-----	--	--

6x4		art. 0830214S.C00 art. 0830214S.C43 art. 0830214S.C28 art. 0830214S.C20
-----	--	--

4x4		art. 0832016N.C06
-----	--	-------------------













DISPLAY BOX GRANADA 182PCS

ART. 0830141N.C3S

1/1/-















- 24x  art. 0830025N.C3S
- 24x  art. 0830026N.C3S
- 24x  art. 0830027N.C3S
- 24x  art. 0830043N.C3S
- 12x  art. 0830032N.C3S
- 24x  art. 0830051N.C1M
- 8x  art. 0830030N.C3S
- 9x  art. 0830165N.C71
- 12x  art. 0832005N.C06
- 12x  art. 0832015N.C06

DISPLAY BOX TUSCANY 186PCS

ART. 0830141N.C5T





1/1/-



- 24x  art. 0830027N.C5T
- 9x  art. 0830165N.C71
- 8x  art. 0830030N.C5T
- 24x  art. 0830026N.C5T
- 24x  art. 0830043N.C5T
- 24x  art. 0830025N.C5T
- 12x  art. 0830032N.C5T
- 6x  art. 0830039N.C06
- 24x  art. 0830051N.C5T
- 4x  art. 0830042N.C4S
- 6x  art. 0832016N.C06
- 12x  art. 0832005N.C06

DISPLAY BOX SPACE 210PCS

ART. 0830141N.C7B
1/1/-

- 24x  art. 0830027N.C7B
- 9x  art. 0830185N.C7B
- 4x  art. 0830030N.C7B
- 9x  art. 0830023N.C7B
- 8x  art. 0830187S.C7B
- 24x  art. 0830026N.C7B
- 12x  art. 0830043N.C7B
- 8x  art. 0830021N.C7B
- 24x  art. 0830025N.C7B
- 3x  art. 0830039N.C34
- 8x  art. 0830058N.C7B
- 9x  art. 0830055N.C34
- 12x  art. 0830032N.C7B
- 12x  art. 0830051N.C34
- 8x  art. 0830059N.C7B
- 6x  art. 0832016N.C34
- 24x  art. 0832005N.C06
- 6x  art. 0832016N.C06



DISPLAY BOX BLUE OCEAN 210PCS







ART. 0830141N.C8C
1/1/-

- 24x  art. 0830027N.C8C
- 9x  art. 0830185N.C8C
- 4x  art. 0830030N.C8C
- 9x  art. 0830022N.C8C
- 8x  art. 0830187S.C8C
- 24x  art. 0830026N.C8C
- 12x  art. 0830043N.C8C
- 8x  art. 0830021N.C8C
- 24x  art. 0830025N.C8C
- 3x  art. 0830039N.C8C
- 8x  art. 0830058N.C8C
- 9x  art. 0830055N.C8C
- 12x  art. 0830032N.C8C
- 12x  art. 0830051N.C22
- 8x  art. 0830059N.C8C
- 6x  art. 0832015N.C30
- 6x  art. 0830040N.C8C
- 12x  art. 0832005N.C06
- 12x  art. 0832005N.C30



DISPLAY BOX SPACE 225PCS







ART. 0830130N.C7B
1/1/-

- 48x  art. 0830025N.C7B
- 48x  art. 0830027N.C7B
- 21x  art. 0830185N.C7B
- 48x  art. 0830026N.C7B
- 24x  art. 0830043N.C7B
- 12x  art. 0830030N.C7B
- 24x  art. 0830051N.C34



DISPLAY BOX BLUE OCEAN 225PCS

ART. 0830130N.C8C
1/1/-

- 48x  art. 0830025N.C8C
- 48x  art. 0830027N.C8C
- 21x  art. 0830185N.C8C
- 48x  art. 0830026N.C8C
- 24x  art. 0830043N.C8C
- 12x  art. 0830030N.C8C
- 24x  art. 0830051N.C8C













DISPLAY BOX VENETIAN 180PCS

ART. 0830141N.C9X

1/1/-











- 24x  art. 0830025N.C9X
- 24x  art. 0830026N.C9X
- 24x  art. 0830027N.C9X
- 24x  art. 0830043N.C9X
- 20x  art. 0830032N.C9X
- 18x  art. 0830051N.C9X
- 10x  art. 0830030N.C9X
- 30x  art. 0830208N.C9X
- 6x  art. 0832015N.C06

DISPLAY BOX SEA GREEN 180PCS

ART. 0830141N.C3X

1/1/-





- 24x  art. 0830025N.C9X
- 24x  art. 0830026N.C9X
- 24x  art. 0830027N.C9X
- 24x  art. 0830043N.C9X
- 20x  art. 0830032N.C9X
- 18x  art. 0830051N.C9X
- 10x  art. 0830030N.C9X
- 30x  art. 0830208N.C9X
- 6x  art. 0832015N.C06

DISPLAY BOX NAUTICAL 200PCS

ART. 0830141N.C8S
1/1/-



24x		art. 0830027N.C8S
9x		art. 0830185N.C8S
6x		art. 0830030N.C8S
24x		art. 0830026N.C8S
12x		art. 0830043N.C8S
8x		art. 0830021N.C8S
24x		art. 0830025N.C8S
4x		art. 0830039N.C8C
8x		art. 0830058N.C22
9x		art. 0830055N.C22
12x		art. 0830032N.C8S
12x		art. 0830051N.C22
8x		art. 0830059N.C8S
6x		art. 0832015N.C30
24x		art. 0832005N.C30
4x		art. 0830042N.C8C
6x		art. 0830040N.C8C

DISPLAY BOX CUVÉE - RISERVA 82PCS

ART. 0830138N
1/1/-



















WATER	
6x CUVÉE'	art. 0830200N.C71
6x RISERVA	art. 0830216N.C71
WHITE	
3x CUVÉE'	art. 0830171N.C71
3x RISERVA	art. 0830219N.C71
PROSECCO	
4x CUVÉE'	art. 0830205N.C71
4x RISERVA	art. 0830217N.C71
RED	
4x CUVÉE'	art. 0830184N.C71
3x RISERVA	art. 0830220N.C71
BEER	
4x MUNICH	art. 0830196N.C71
4x SPECIAL	art. 0830173N.C71



DISPLAY BOX COSMIC 195PCS

ART. 0830141N.C8A

1/1/-

- 24x  art. 0830027N.C8A
- 8x  art. 0830030N.C8A
- 12x  art. 0830035N.C8A
- 24x  art. 0830026N.C8A
- 12x  art. 0830043N.C8A
- 24x  art. 0830025N.C8A
- 9x  art. 0830185N.C8A
- 6x  art. 0830039N.C8A
- 12x  art. 0830051N.C8A
- 8x  art. 0830058N.C8A
- 12x  art. 0830055N.C8A
- 12x  art. 0830032N.C8A
- 6x  art. 0832016N.C8A
- 12x  art. 0830021N.C8A
- 6x  art. 0830080N.C8A
- 8x  art. 0830059N.C8A



ENIGMA DINNER PLATE

ART. 0830320N.C5L
24 / 24 / 504



PANAREA DINNER PLATE

ART. 0830320N.C2X
24 / 24 / 504



ENIGMA DEEP PLATE

ART. 0830310N.C5L
24 / 24 / 504



PANAREA DEEP PLATE

ART. 0830310N.C2X
24 / 24 / 504



ENIGMA SIDE PLATE

ART. 0830330N.C5L
24 / 24 / 504



PANAREA SIDE PLATE



















ART. 0830330N.C2X
24 / 24 / 504



DISPLAY BOX SERENADE 200PCS

ART. 0830141N.C6A

1/1/-

- 24x  art. 0830027N.C6A
- 6x  art. 0830030N.C03
- 9x  art. 0830022N.C03
- 24x  art. 0830026N.C6A
- 12x  art. 0830043N.C03
- 24x  art. 0830025N.C6A
- 8x  art. 0830187S.C6A
- 4x  art. 0830039N.C03
- 9x  art. 0830051N.C03
- 6x  art. 0830040N.C03
- 8x  art. 0830058N.C03
- 9x  art. 0830055N.C03
- 12x  art. 0830032N.C6A
- 6x  art. 0832016N.C03
- 6x  art. 0832016N.C06
- 12x  art. 0832005N.C03
- 12x  art. 0832005N.C06
- 9x  art. 0830035N.C6A



ENIGMA BOWL

ART. 0830350N.C5L
24 / 24 / 1344



PANAREA BOWL

ART. 0830350N.C2X
24 / 24 / 504



ENIGMA MUG

ART. 0830140N.C5L
24 / 24 / 768



PANAREA MUG

ART. 0830140N.C2X
24 / 24 / 768



VINIS FOLD-AWAY

ART. 0203062C.C9N
1/1/-



STAY MAT S

ART. 0201030N
24/24/960



STAY MAT M

ART. 0201031N
24/24/576



TIDY

ART. 0203020N
24/24/576



WC-MASK

ART. 0402031N
20/160/-



CLEO FOLD-AWAY

ART. 0203064C.C9N
12/12/216



BIKE COVER 2/3

ART. 7130219N
4/4/80



BIKE COVER 4

ART. 7130210N
4/4/72



BIKE COVER SPECIAL 2/3

ART. 7130200N
4/4/84



BIKE COVER CVN 2

ART. 7130212N
4/4/72



E-BIKE COVER 2

ART. 7130220N
4/4/72



INDICE

A

Accendino USB	300
Accessori elettrici 12V	361,362
Accessori gas	308,309
Accessori per gazebo	76
Accessori BBQ	306,307
Accessori per gazebo	87
Adattatori 13 poli	362
Alimentatore elettrico	333
Allarme fughe gas	343
Amache	136
Angolari di protezione	378
Appendiabiti a gancio	320
Armadietto pensile	199
Articoli in silicone/TPE	286,287-312,315
Aspirapolvere 12V	350
Aspirapolvere ricaricabile 230V	350
Aste bloccastoviglie	323
Avvolgicavo	339-362,363
Avvolgitubo	373

B

Bacinelle	312-314
Basi antisprofondamento	400
Basi per gazebo	76
Bauli per trasporto	398
BBQ a gas da tavolo	303
BBQ a gas	304,305
Bicchieri	337-254,265
Bilancia pesabombole	342
Bilancia pesatimone	400
Bocca erogazione automatica	370
Boccali inox	250
Boccali termici	236
Bollitore elettrico	356
Bollitore per latte	356
Bollitori	288
Bombolette gas	296
Borse termiche	334-337
Borse trasporto	392,393-398
Bottiglie inox	336
Bottiglie termiche	336
Bottoni a pressione	98
Brandine	166,167

C

Candele citronella	134
Caffettiera	289
Caraffe	261
Carrelli portatutto	172,173
Carretto portatutto	170,171
Cartelli carichi sporgenti	391
Cassaforte	398
Cassetta portaoggetti	397
Cavi e adattatori	362,365

Cestini pensili	317,319
Cestino portarifiuti	317
Cesto multiuso	315
Cinghie di fissaggio	38-89-91
Ciotola cani	250
Colapasta	287
Compressore 12V	351
Conchiglie paravento/sole	68,69
Condizionatore d'aria	344,347
Contentore per zampironi	134
Coperchio grill	302-307
Coperchi pentole	266
Coperchio per Vinis	312
Coperte pic-nic	133
Copertura camper	378,379-382
Copertura caravan	380-383
Coperture di protezione	381-384,385
Copribombola gas	387
Coprioblò	384
Copriredili igienici	368
Copribicicletta	390
Corde di tensione	89
Corde elastiche	90
Cubetti Ghiaccio	262
Cunei d'arresto	401
Cunei di stazionamento	401
Cuscini poggiatesta	126,127

D

Dispositivo monitoraggio VR	343
Distanziatori coperture	378
Divani	163
Detergenti	374,375
Doccia da viaggio	370,371
Doccia solare	370

E

Elastici per tende	90
--------------------	----

F

Fermabauletti	400
Fornelli a gas	293,300
Frigobox elettrici 12/230V	324,333

G

Ganci	88-94
Gazebi	73,77
Gazebi per Outdoor	62,67
Gazebi pieghevoli	74,77
Ghirbe e taniche	368,369
Gonfiatore 12V	130-351
Gradini	394,397
Grembiule paravento	387
Griglia di partenza	400
Grill da tavolo	294,295-297
Grill portatili	294,295-297

I

Imbuto	337,373
Impermeabilizzanti	374
Inserito per panierie	315
Inverter	340

K

Kit collegamento tende minibus	39-95
--------------------------------	-------

L

Lampada veranda	358-360
Lampade da campeggio	116,121
Lampade frontali	121
Lampade da tavolo	117
Lavello pieghevole	312-315
Lettini da campo	135-165
Livelle a bolla	401
Luce armadio	359
Luce entrata	358

M

Macchina Espresso	357
Martelli da campeggio	93
Martinetti	401
Materassini autogonfianti	128
Materassini isolanti	132
Materassini pneumatici	129
Materassini ultraleggeri tubi	130,131
Materassino da spiaggia	131
Mattonelle ghiaccio	335
Mepo Box	269
Mobiletti cucina	194,197-200,201

Mobiletti per tende	194
---------------------	-----

Mobili armadi	194,195,198
---------------	-------------

Morsetto di stabilizzazione	38-94,95
-----------------------------	----------

Morsetti bloccapali	94-95
---------------------	-------

Morsetti bloccatiloni	88-99
-----------------------	-------

N

Necessaire da viaggio	137
-----------------------	-----

O

Occhielli	98,99
-----------	-------

Oliera/acetiera	240
-----------------	-----

Ombrelloni parasole	78,81
---------------------	-------

Ombrellone con pareti laterali	80
--------------------------------	----

Omni-Box	285
----------	-----

Oscuranti termici	386
-------------------	-----

P

Pale/zappe	92
------------	----

Pali supplementari tende	93-95,96
--------------------------	----------

Palo antibufera	96
-----------------	----

Palo telescopico alluminio	95
----------------------------	----

Panierie multiuso	312
-------------------	-----

Parete frontale parasole/parapioggia	35
--------------------------------------	----

Parete laterale parasole/ parapioggia	35
Paravento	70,71
Paravento fornelli	196
Pareti laterali per gazebi	75,77
Pareti laterali per tendalini	21
Pedane	110
Pentolame alluminio	266,281
Pentolame inox	282,286
Pentola a pressione	267
Pentola elettrica	356
Phon da viaggio	348,349
Piastra di cottura	280
Piastra di cottura elettrica	354,355
Piastra grill	292
Picchetti in metallo	82,87-106
Picchetti in plastica	84-86-106
Picchetti porta-ombrelloni	81
Pinza prendipentola	281
Plafoniere	358
Poltrone pieghevoli	139,152-162
Pompe acqua ad immersione	371
Pompe di gonfiaggio	39-130
Poncho impermeabile	136
Portabicchieri	315-323
Portapiatti	323
Portasacchetto rifiuti	317
Portaspezie	233
Portoggetti	199
Posacenere	236-240
Posate	233-250- 252,253
Posate cucina	280
Posatoni grill	306
Prodotti chimici	374,375
Profilo di collegamento	95
Profilo di scorrimento	95
Profilo in alluminio	95
Prolunghe	363
Puntale palo	94
R	
Rete portaoggetti	190-398
S	
Sacche custodia	392,393
Sacche impermeabili	137
Sacchetti portarifiuti	316-318,368
Sacchiletto	124,126
Sacchetto ultraleggero	126
Saliera/Pepiera	240
Scale pieghevoli	399
Scolapiatti	314
Scopa per tende e verande	322
Secchiello pieghevole	313

Secchio multiuso	315
Sedie Action	160,161
Sedie pieghevoli	138,161
Sedie regista	153-155
Sedie Relax	143-149
Seggiolone per baby	161
Serbatoi mobili	367
Set paletta/scopetta	322
Sfera bloccatiloni	99
Sgabelli	148-164
Spazzola lavaggio telescopica	372
Spazzola lavastoviglie	314
Spazzolini WC	372
Specchi retrovisori	402,403
Spiaggine	168,169
Spine e prese 12V	362
Spine e prese 13P	362
Spine e prese 220V	363,364
Staccabatteria	362
Stendibiancheria	320,321
Stoviglie in acciaio	250
Stoviglie in melamina	202,249
Stufetta a gas	301
Stufetta ad aria	352,353
Stufette elettriche	352,353
Stuoia antiscivolo	323
Stuoia spiaggia	132,133
Stuoie per verande	100,109
Stuoie protezione	99
T	
Taglieri	238-240- 247-251
Tanica acqua	369
Tappeti cabina	388,389
Tappo adattatore con raccordo	373
Tavoli da campeggio	159-174,192
Tavolo sgabello	147-182
Tazza	206
Tazzina Espresso	206
Tazzone	206
Telaio portarifiuti	316
Telaio portafrigo	329
Teloni	98,99
Tendalino camper	21-34,35
Tendalini caravan	37
Tende	9,53
Tendalini parasole	34,36
Tende cucina	54,59
Tende Family	42,51
Tende Minibus	10,16-17- 22,29
Tende multifunzionali	60,61

Tende per porte	112,113
Tende pneumatiche	40,49
Tende portellone posteriore	30,33
Tenditori	88
Tostapane elettrico	356
Tostapane per fornelli	280
Treppiede antenna	399
V	
Vela Parasole per spiaggia	69
Ventilatore frigo	340,341
Ventilatori	348,349
Ventose	386
Ventose per tende minibus	38-88-366
Veranda gonfiabile	26
Verande ultraleggere	24
W	
WC portatile	368
Z	
Zaini termici	334
Zanzariere	134-377
Zanzariciller	361
Zerbini	111-389



GARANZIA

I prodotti originali Brunner sono realizzati con materiali di ottima qualità, tenendo conto dell'utilizzo al quale verranno normalmente sottoposti. Severi controlli di qualità hanno lo scopo di fornire prodotti privi di difetti di materiale e/o di produzione. In caso si riscontrasse comunque uno dei difetti sopracitati, entra in azione la garanzia del prodotto che ha una durata di 24 mesi dalla data di acquisto.

ATTENZIONE:

La garanzia non copre difetti dovuti ad un utilizzo improprio o scorretto del prodotto stesso. Sono esclusi dalla garanzia anche difetti causati da un uso particolarmente prolungato del prodotto e dalla normale usura dei componenti che ne consegue.

L'articolo che presentasse i difetti sopra citati, dovrà essere consegnato al punto vendita in cui è stato effettuato l'acquisto, unitamente allo scontrino fiscale comprovante la data di tale transazione.

Il rivenditore provvederà ad effettuare tutte le operazioni necessarie per far pervenire il prodotto difettato alla Brunner srl o al distributore.

- Colori, misure e materiali dei prodotti e degli imballi sono indicativi e non impegnativi. Ci riserviamo di apportare modifiche tecniche ai prodotti illustrati.

Attenzione: i colori dei prodotti possono differire dall'originale per motivi tipografici. Non rispondiamo per eventuali errori di stampa.

- E' vietata la riproduzione, anche parziale, di testi, schemi, grafiche ed immagini contenuti nel presente catalogo.

- L'oggettistica decorativa non è compresa nel prezzo indicato.

- Diritti riservati. Questo catalogo o ogni sua parte non può essere riprodotto senza l'autorizzazione della ditta Brunner s.r.l.



BRUNNER INTERNATIONAL

HEAD OFFICE • ITALY • BRUNNER SRL/GMBH
VIA B. BUOZZI, 8 • BUOZZISTRASSE 8
I - 39100 BOLZANO • BOZEN
T: +39 0471 542900
INFO@BRUNNER.IT

CZECH REPUBLIC

BRUNNER SRL/GMBH
VIA B. BUOZZI, 8
I - 39100 BOLZANO
T: +39 0471 542900
INFO@BRUNNER.IT

FRANCE

ALPA ACCESSOIRES
ZA SAINT-MÈMAIN - VOVES
28150 LES VILLAGES-VOVÉENS
T: +33 (0)2 37182775
COMMERCIAL@ALPA-ACCESSOIRES.COM
WWW.ALPA-ACCESSOIRES.COM

ISRAEL

LAOFEK CARAVAN & CAMPING
HAYETZIRA STREET, 6
IL - 4951232 PETAH-TIKVA
T: +972-3-744-3344
INFO@LAOFEK.CO.IL
WWW.LAOFEK.CO.IL

POLAND

GOMARKET.PL
WYBRZEŻE GDYŃSKIE, 2
PL - 01-531 WARSZAWA
T: +48 (0)22 8392024
BIURO@GOMARKET.PL
WWW.GOMARKET.PL

SPAIN AND PORTUGAL

CASMAT SPORT, S.L
POLIGONO INDUSTRIAL CAN ROSES
CTRA. MOLINS A SABADELL, KM 13,
08191 RUBI (ESPAÑA)
T: +34 93 588 75 39
INFO@CASMATSPORT.COM
WWW.CASMATSPORT.COM

DENMARK

DCT VEJLE A/S
KNUD HØJGAARDS VEJ, 2
DK-7100 VEJLE DENMARK
T: +45 7582 4800
DCT@DCT-VEJLE.DK
WWW.DCT-VEJLE.DK

GERMANY AUSTRIA SWITZERLAND

BRUNNER SRL/GMBH
BUOZZISTRASSE, 8
I - 39100 BOZEN
T: +39 0471 542900
INFO@BRUNNER.IT

NEW ZEALAND

BURNSCO
RONWOOD AVENUE, 5
NZ - 2104 MANUKAU - AUCLAND
T: 0800 10 20 41
WEBSITE@BURNSCO.CO.NZ
WWW.BURNSCO.CO.NZ

SLOVENJA

TECA D.O.O
CESTA LJUBLJANSKE BRIGADE, 9
SI - 1000 LJUBLJANA
T: +386 1 5838030
INFO@TECA.SI
WWW.CARAVAN.SI

TURKEY

PERA KARAVAN KAMP
TURİZM TİCARET LTD. ŞTİ.
34829 BEYKOZ - İSTANBUL
T: +90 530 525 08 94
INFO@PERACAMPING.COM
WWW.PERACAMPMARKET.COM

BENELUX

BRUNNER SRL/GMBH
VIA B. BUOZZI, 8 • BUOZZISTR. 8
I - 39100 BOLZANO • BOZEN
T: +39 0471 542900
INFO@BRUNNER.IT

ESTONIA

HEIDENLINE OÜ
HÄRGMÄE, 24
EE - 13525 TALLINN
T: +372 50 19791
TELLIMUSED@MATKASUVILAD.EE

GREECE

ZAMPETAS
18 KM THESSALONIKIS - PEREAS
GR - 570 19 PEREA
T: +30 23920 71760
INFO@ZAMPETAS.GR
WWW.ZAMPETAS.GR

NORWAY

CARAVAN SUPPLY AS
TEGLVERKSVEIEN, 100
N - 3057 SOLBERGELVA
T: +47 32885533
POST@CASU.NO
WWW.CASU.NO

NORWAY

MAX FRITID ENGROS AS
RAUMAVEGEN 55
6300 ÅNDALSNES
T: +47 57 00 99 70
EHANDEL@MAXFRITID.NO
WWW.MAXFRITID.NO

UNITED KINGDOM

BRUNNER UK
SIMON CORNALL ASSOCIATES LTD
WALKER THOMPSON, EMPRESS HOUSE,
43A BINLEY ROAD, COVENTRY, CV3 1HU
M: +44(0) 7840 835185
SIMONBRUNNERUK@GMAIL.COM

CROATIA

MERIDIAN NAUTIKA D.O.O.
MATE VLAŠIĆA, 24/A
HR - 52440 POREČ
T: +385(0) 52 453 096
INFO@MERIDIAN.HR
WWW.MERIDIAN.HR

FINLAND

KEHA CARAVAN TUKKU OY
KOSKELONTIE, 15
FIN-2920 ESPOO
T: +358 40 7794595
PALAUTE@CARAVANTUKKU.FI
WWW.CARAVANTUKKU.FI

ICELAND

VIKURVERK EHF
VÍKURHVARF, 6
IS - 203 KÓPAVOGUR
T: +354 557 7720
VIKURVERK@VIKURVERK.IS
WWW.VIKURVERK.IS

SWEDEN

DCT VEJLE A/S
KNUD HØJGAARDS VEJ, 2
DK-7100 VEJLE DENMARK
T: +45 7582 4800
DCT@DCT-VEJLE.DK
WWW.DCT-VEJLE.DK

SWEDEN

KAMA FRITID AB
MOMARKEN 3
SE-556 50 JÖNKÖPING
T: +46.36.353723
INFO@KAMAFRITID.SE
WWW.KAMAFRITID.COM

BRUNNER 

A company from
SÜDTIROL